

A vertical stream of water falls from the top left, splashing into a pool of water at the bottom. The water is clear and blue, with many small droplets and ripples. The background is white.

Leak Detection

Technology and Implementation

Stuart Hamilton and Bambos Charalambous

SECOND EDITION



Leak Detection

Technology and Implementation

Leak Detection

Technology and Implementation

Second Edition

Stuart Hamilton and Bambos Charalambous



Published by

IWA Publishing
Alliance House
12 Caxton Street
London SW1H 0QS, UK
Telephone: +44 (0)20 7654 5500
Fax: +44 (0)20 7654 5555
Email: publications@iwap.co.uk
Web: www.iwapublishing.com

First published 2020
© 2020 IWA Publishing

Apart from any fair dealing for the purposes of research or private study, or criticism or review, as permitted under the UK Copyright, Designs and Patents Act (1998), no part of this publication may be reproduced, stored or transmitted in any form or by any means, without the prior permission in writing of the publisher, or, in the case of photographic reproduction, in accordance with the terms of licenses issued by the Copyright Licensing Agency in the UK, or in accordance with the terms of licenses issued by the appropriate reproduction rights organization outside the UK. Enquiries concerning reproduction outside the terms stated here should be sent to IWA Publishing at the address printed above.

The publisher makes no representation, express or implied, with regard to the accuracy of the information contained in this book and cannot accept any legal responsibility or liability for errors or omissions that may be made.

Disclaimer

The information provided and the opinions given in this publication are not necessarily those of IWA and should not be acted upon without independent consideration and professional advice. IWA and the Author will not accept responsibility for any loss or damage suffered by any person acting or refraining from acting upon any material contained in this publication.

British Library Cataloguing in Publication Data

A CIP catalogue record for this book is available from the British Library

ISBN: 9781789060843 (Paperback)
ISBN: 9781789060850 (eBook)
ISBN: 9781789060867 (ePub)

This eBook was made Open Access in July 2022

DOI: 10.2166/9781789060850

© 2022 The Authors

This is an Open Access eBook distributed under the terms of the Creative Commons Attribution Licence (CC BY 4.0), which allows users to copy and distribute, to create extracts, abstracts and new works from the Work, to alter and revise the Work, and to make commercial use of the Work, provided the user gives appropriate credit (with a link to the formal publication through the relevant DOI), provides a link to the licence, and that the licensor is not represented as endorsing the use made of the work. The full details of the licence are available at <http://creativecommons.org/licenses/by/4.0/>.



Contents

About the Authors	xiii
-------------------------	------

Chapter 1	
<i>Introduction</i>	1

Chapter 2	
<i>The technology matrices</i>	3
2.1 Main Pipelines Only – High Pressure	4
2.2 Main Pipelines Only – Low Pressure	5
2.3 Domestic and Mains Fittings – High Pressure	6
2.4 Domestic & Mains Fittings – Low Pressure	7

Chapter 3	
<i>Acoustic principles</i>	9
3.1 History of Acoustics	9
3.2 Propagation	10
3.3 Resonance	10
3.4 Attenuation	10
3.5 Acoustic Impedance	11

Chapter 4	
<i>Leak detection technologies</i>	13
4.1 Method A: Gas Injection Method	13
4.2 Method B: Manual Listening Stick	14

4.3	Methods C and D: Leak Location Using Acoustic Noise	
	Correlation Theory	14
4.4	Method C: Non-intrusive Correlation with Accelerometer Sensors	15
4.5	Method D: Correlation Using Hydrophones	16
4.6	Technologies for Leak Noise Correlation	19
4.6.1	Correlating loggers with remote communications via radio or cellular networks	19
4.6.2	Correlating loggers for on-site leak location – manual download	22
4.6.3	Radio-based correlator (for on-site leak location)	24
4.6.4	Potential sources of error in correlation leak location	25

Chapter 5

	<i>Method E: In-line leak detection techniques</i>	29
5.1	Tethered Systems	29
5.2	Free Swimming Systems	31

Chapter 6

	<i>Method F: Noise loggers – non-correlating</i>	33
6.1	Direct Download	34
6.2	Drive by Patrol	34
6.2.1	Fixed	35
6.2.2	Survey	35
6.3	Lift and Shift	35
6.4	Permanent Installation	36
6.5	Noise Logger Principal of Use	38

Chapter 7

	<i>Method G: Electronic amplified listening devices</i>	39
7.1	Operational Practice	40
7.2	Survey by Listening at Fittings – Electronic Listening “Stick” Accessory	41
7.3	Survey/Pinpointing by Surface Sounding “Elephants Foot” – Hard Ground	42
7.4	Operational Efficiency – Survey vs. Confirmation	42
7.5	Advanced Features	43
7.5.1	Filters	43
7.5.2	Memory comparison	44
7.6	Amplification	45
7.7	Remote Communication	46
7.8	Advantages and Disadvantages	46
7.9	Conclusions	46

Chapter 8***Method H: Acoustic correlation using accelerometers on large diameter pipe or non-metallic pipes*** 47

- 8.1 Theory of Operation 47
- 8.2 The Technology 47

Chapter 9***Method I: Acoustic correlation using hydrophones on large diameter pipes and on non-metallic pipes*** 49

- 9.1 Permanent Correlation Monitoring Using Hydrophone Sensors 50

Chapter 10***Other techniques*** 53

- 10.1 Thermal Imaging 53
- 10.1.1 Low level surveys 53
- 10.1.2 Higher level surveys 53
- 10.2 Pipeline Inspection with Thermal Diagnostics 54
- 10.3 Inspection of Pipelines Using Infra-red or Thermal Imaging Cameras 54
- 10.4 Drones for Leak Detection Activities 55
- 10.5 Dogs Used for Leak Location 56
- 10.5.1 A dog's nose 56
- 10.5.2 How does a dog complete leak detection? 56
- 10.5.3 Dogs vs conventional methods 57
- 10.6 Ground Penetrating Radar 57

Chapter 11***Optimization tools for leak location – Hydraulic model*** 59

- 11.1 Optimization Principle 59
- 11.2 System Evaluation 59
- 11.2.1 Field data process 60
- 11.2.2 Optimization analysis 60
- 11.2.3 Post-optimization analysis 60

Chapter 12***Step testing*** 63

- 12.1 Principles of Step Testing 63
- 12.2 Advances in Step Testing 66

Chapter 13***Software-based solutions*** 69

- 13.1 Introduction 69
- 13.1.1 1st phase: Anomaly/Leak detection by analytics 69
- 13.1.2 2nd phase: Event detection by analytics 69

13.1.3	3rd phase: Event management	69
13.1.4	4th phase: Central event management (CEM)	70
13.2	About Central Event Management	70
13.3	Bridging Operational Silos	71
13.4	CEM Integration Example	72
13.4.1	A brief case study	72
13.5	Summary	73

Chapter 14

Satellite leak location	75	
14.1	Background	75
14.2	Remote Earth Imaging	76

Chapter 15

Geospatial AI for pipeline failure risk	81	
15.1	Logger Deployment	82
15.2	Survey Prioritisation	82
15.3	Consequence Analysis	82
15.4	Conclusions	83

Chapter 16

Method Z – Customer-side leakage using temperature and vibration	85	
16.1	Introduction	85
16.2	Customer-side Leak Detection from Temperature Measurements	86
16.3	Vibration Measurements for Flow Detection	87

Chapter 17

Case studies	89	
17.1	New Braunfels Utilities (NBU), Texas, USA cuts water loss by 50%	89
	Abstract	89
	Introduction	89
	Problem description	89
	Solution provided	89
	Results obtained	90
17.2	'Lift and Shift' Leak Monitoring Reduces Losses and Costs for Veolia Water	90
	Abstract	90
	Introduction	90
	Problem description	90
	Solution provided	90
	Results obtained	91

17.3	Leak Noise Correlator and Ground Microphone Technology Used in Zibo City, Shandong, China to Pinpoint Leaks in their Network	91
	Abstract	91
	Introduction	91
	Problem description	91
	Solution provided	92
	Results obtained	92
17.4	Reducing Leakage at Thames Water	92
	Abstract	92
	Introduction	92
	Problem description	92
	Solution provided	92
	Results obtained	93
17.5	Leak Detection for Ankara Water and Sewerage Administration (ASKI)	94
	Abstract	94
	Introduction	94
	Problem description	94
	Solution provided	95
	Results obtained	95
17.6	Leak Detection Program in Manila, Philippines	96
	Abstract	96
	Introduction	96
	Problem description	96
	Solution provided	96
	Results achieved	96
17.7	Long Distance Large Pipeline Inspection	97
	Abstract	97
	Introduction	97
	Problem description	97
	Solution provided	98
	Results obtained	98
17.8	Potable Water Pipeline Inspection in North America	99
	Abstract	99
	Introduction	99
	Problem description	99
	Solution provided	99
	Results obtained	100
17.9	A Full-Scale Active Leakage Control Project from a China Water Utility	101
	Abstract	101
	Passive vs. active	101
	Problem description	101
	Solution	101
	17.9.1 Step 1. DMA Planning	102
	17.9.2 Step 2. Flow and pressure monitoring	102
	17.9.3 Step 3. Water leak pin-pointing	105

17.9.4	Step 4. Leak confirmation	106
17.9.5	Conclusion	106
17.10	Remote Leak Location Technology Gives Reduced Losses in Anglian Water	106
	The challenge	106
	Fixed correlating noise loggers – the vision	106
	Trials in town of Louth, Lincolnshire, UK	106
	Advanced performance	108
17.11	Leak Located over 1458 metre plus a Second Leak to Halve the Nightline	109
	Introduction	109
	The challenge	109
	Installation	109
	Results	111
17.12	Systematic Leak Reduction in Israel – a ZONESCAN Noise Logger	
	Project by Gutermann	111
	Project background	111
	Mei Carmel – a public utility “start-up” with big ambitions	112
	Why did Mei Carmel invest in leak monitoring technology?	112
	Haifa’s integrated leak reduction programme	113
	ZONESCAN Alpha setup	113
	Results of the ZONESCAN Alpha pilot installation	115
	Everything you need in one screen in the cloud	115
	Accuracy of the system	116
	Roll-Out of Phase 1 and immediate success	117
	Fast reduction in non-revenue water following the first eight months	118
	Continuing the ZONESCAN Alpha expansion in Haifa	118
	Conclusions	119
17.13	Gutermann ZONESCAN 820 Acoustic Noise Logging Case Study – South	
	East Water	119
	Introduction	119
	Challenge	119
	Solution	119
	Results	121
17.14	Park City, Utah	121
	Introduction	121
	Challenge	122
	Programme highlights	122
	Solution	123
	Outcome	123
17.15	Trunk Main Correlation	124
	Introduction	124
	Scope of work	125
	Correlation survey	125
	Upstream correlation	125
	Downstream correlation	126
	Summary	127
17.16	AQUASCAN TM2 with Hydrophones	127
	Introduction	127

Challenge	128
Solution	128
Conclusion	128
Detailed Results	129
17.17 United Utilities – Advanced Trunk Main Leak Location	133
Introduction	133
Trial details	133
Scilly Bank	133
Results	134
Follow up	135
17.18 Ranhill SAJ, Johor, Malaysia – Meeting the Challenge for Remote Leak	
Pinpointing	136
Introduction	136
The challenge	136
Trial at Bandar Putra, Johor Bahru, Johor	137
Net Night Flow reduction	137
17.19 Affinity Water Changing the Economics of Leak Detection with	
PermaNet+	138
17.20 Scottish Water Adopts Acoustic Noise Logging	138
Crompton DMA – Map view	139
Crompton DMA – Logger Data view	140
Logger histogram	141
Street view	141
Enigma test report	141
Results	141
17.21 Satellite Leak Location – Utilis	142
17.22 Software-Based Solution	143
Background	143
Hidden leak event “lifecycle”	143
Results: significant water and cost savings	144
Summary	144
17.23 Reducing NRW in Wilson County – Tennessee	145

Chapter 18

Appendices 151

Paper 1: Water balance – From the desktop to the field	151
<i>B. Charalambous and S. Hamilton</i>	
Introduction	152
Water Audit	152
Assessing Losses – IWA Water Balance	153
Case Study Examples	154
Top down approach	154
Bottom up audit – case study to show bottom up and top	
down comparisons	157
Benchmarking of non-revenue water	158
Conclusions	158

Further Reading	159
Paper 2: Intermittent supply leakage nexus – Dealing with the complex interrelation of intermittent supply and water losses	160
<i>Bambos Charalambous and Roland Liemberger</i>	
General	160
The Vicious Cycle of IWS	161
Implications of IWS	161
Myth busters	163
The challenge	166
The need for a standardized approach	166
Conclusions/Key learning points	167
References	167
 Paper 3: The problem of leakage detection on large diameter mains	 169
<i>Stuart Hamilton and Daniel Krywyj</i>	
Introduction	169
Background	169
Human ear frequency range	169
Case Studies	171
Life of a Leak	171
Hz – Leak Noise	172
Conclusions	175
Acknowledgements	176
Further Reading	177
 Paper 4: Technology – How far can we go?	 178
<i>Stuart Hamilton and Daniel Krywyj</i>	
Introduction	178
Background	178
What is Technology?	179
Active Leakage Control	180
Waterpipe	181
Leaking	181
Pressure Management	181
Speed and Quality of Repairs	181
Renewal of Pipelines	182
Methodologies in Reducing Apparent Losses	182
Meter Error – Meter Under Registration	182
Automatic Meter Reading	182
Software	182
Communication Systems	183
Software Applications	183
Innovation in the Future – Conclusions	184
Further Reading	184

About the Authors

Principal Authors 1st and 2nd Edition

Stuart Hamilton: shamilton@hydrotec.co

Hydro Tec Ltd, The Barn, Thorpe Underwood, Northampton, NN6 9PA, UK.

Bambos Charalambous: bcharalambous@cytanet.com.cy

Managing Director, Hydrocontrol Ltd, Lemesos, Cyprus.

Author 1st and 2nd Edition

Roger Ironmonger: rogerci51@hotmail.co.uk, sales@primayer.com

Primayer Ltd., Primayer House, Parklands Business Park, Denmead, Hampshire PO7 6XP, UK

Authors 1st Edition

Mike Tennant: MTennant@hwm-water.com

Halma Water Management, Ty Coch House, Llantarnam Park Way, Cwmbran NP44 3AW, UK

Mike Wrigglesworth: Mike.Wrigglesworth@xyleminc.com

Xylem Inc.300-705 11th Ave SW, Calgary, AB, Canada

Contributing Authors – 1st Edition

Seba KMT

Steve Tooms

Stuart Trow

Gosta Lange

Andrew Chastain Howley

Claude Gutermann

Aristides Adamou

Christodoulos Christodoulou
Sophie Kanellopoulou
Zheng Wu
Tony Green

Contributing Authors – 2nd Edition

Mike Wrigglesworth: Mike.Wrigglesworth@xyleminc.com

Mike Tennant: MTennant@hwm-water.com

Stuart Trow: stuarttrow@aol.com

Uri Gutermann: uri.gutermann@gutermann-water.com

Rezatec: philip.briscoe@rezatec.com

Amir Peleg: amir.peleg@takadu.com

Utilis: karen.d@utiliscorp.com

Acknowledgements

The authors would like to acknowledge the help and support of members of the IWA Water Loss Specialist Group

Chapter 1

Introduction

Ageing infrastructure and declining water resources are major concerns with a growing global population. Controlling water loss has therefore become a priority for water utilities around the world. In order to improve their efficiencies, water utilities need to apply good practice in leak detection.

The reasons for controlling leaks and reducing Non-Revenue Water have been well documented. Through the Water Loss Specialist Group and its Working Groups, the IWA has established several relevant guidelines, including the IWA Standard Water Balance and the Basic Management Strategies for Reducing Leakage.

To deal with losses in an effective manner, particularly from networks in water scarce areas, water utility managers are increasingly turning to technology to reduce costs, increase efficiency and improve reliability. Companies that continuously invest in technology and innovation should see a positive return on investment in terms of improving daily operations and collection and analysis of network data for decision making and forward planning.

The purpose of this document is to assist water utilities with the development and implementation of leak detection programs. Leak detection and repair is one of the components of controlling water loss. In addition to the techniques discussed within this document, water utilities should consider the other related Good Practices established by the IWA Water Loss Specialist Group.

Methodologies for achieving the best results to reduce water losses are continuously evolving. Water companies and equipment manufacturers are increasingly working together in an effort to stretch the boundaries of current knowledge. This is leading to some innovative technologies and new product development to complement current methodologies. This document reflects the situation at the time of publication.

The second edition updates practices and technologies that have been introduced or further developed in recent years in leakage detection outlining recent advancements in technology used, such as satellite-aided methods in leak location, pipeline inspection with thermal diagnostics, inspection of pipelines by air using infra-red or thermal imaging cameras, drones for leak detection activities and even sniffing dogs. In addition, this second edition is enriched with new case studies which provide useful examples of practical applications of several leak-detection practices and technologies.

Chapter 2

The technology matrices

The choice of a particular leak detection/location technique and technology depends on the operating conditions and construction material of the pipeline in question. To assist in making this determination, four different matrices have been developed.

- (1) Mains fittings only – High Pressure ([Figure 2.1](#))
 - For leakage detection on mains fittings only (no house connections) with pressures greater than 10 m head or 15 psi. Fittings are at a minimum distance of 200 m apart and maximum 500 m
- (2) Mains fittings only – Low Pressure ([Figure 2.2](#))
 - For leakage detection on mains fittings only (no house connections) with pressures less than 10 m head or 15 psi. Fittings are at a minimum distance of 200 m apart and maximum 500 m
- (3) Domestic and mains fittings – High Pressure ([Figure 2.3](#))
 - For leakage detection on all property and mains fittings with pressures greater than 10 m head or 15 psi. Fittings are at a minimum distance of 10 m apart and maximum 50 m
- (4) Domestic and mains fittings – Low Pressure ([Figure 2.4](#))
 - For leakage detection on all property and mains fittings with pressures less than 10 m head or 15 psi. Fittings are at a minimum distance of 10 m apart and maximum 50 m

The matrices consider the following pipeline materials:

- Metallic
 - includes steel, ductile iron and other ferrous materials
- Concrete
 - includes reinforced concrete, pre-stressed concrete pipe (PCP)
- Asbestos cement
- Glass-reinforced plastic (GRP)
- Polyvinyl chloride (PVC)

- Polyethylene
 - MDPE Medium density polyethylene
 - HDPE High density polyethylene

The technologies available are discussed in more detail later in this document. The equipment has been placed in the selected categories where it is reliably successful. The equipment may sometimes be successful in other categories but not reliably so.

Note that new equipment is continuously being developed: these matrices only take into account equipment that was available during the preparation of the matrices (up to December 2018).

2.1 MAIN PIPELINES ONLY – HIGH PRESSURE

This matrix is for leakage detection on mains fittings only (no house connections) with pressures greater than 10 m head or 15 psi. Fittings are at a minimum distance of 200 m apart and maximum 500 m.

Diameter	mm	75	100	150	200	250	300	350	400	450	500	600	700	800	900	1000+
	inches	3	4	6	8	10	12	14	16	18	20	24	28	32	36	40+
Material																
Metallic all	A,B, C,D, F,G	A,B, C,D, F,G	A,B, C,D, F,G	A,B, C,D, F,G	A,B, C,D, F,G	A,B, C,D, F,G	A,C, D,E, F,G	A,C, D,E, F,G	A,C, D,H, F,G,H,I	C,D,E, H,I	C,D,E, H,I	D,E, H,I	D,E, H,I	E, H,I	E, H,I	E, H,I
Concrete all	A,C,D	A,C,D	A,C,D	A,C,D	A,C,D	A,D,H	A,D,E	A,D,E	A,D,E	E,I	E,I	E,I	E,I	E,I	E,I	E,I
Asbestos Cement	A,C,D	A,C,D	A,C,D	A,C,D	A,C,D	A,D,H	A,D,E	A,D,E	A,D,E	E,I	E,I	E,I	E,I	E,I	E,I	E,I
GRP	A,D	A,D	A,D	A,D	A,D,H	A,D,H	A,D,E	A,D,E	A,D,E	E,I	E,I	E,I	E,I	E,I	E,I	E,I
PVC	A,D	A,D	A,D	A,D	A,D,H	A,D,H	A,D,E	A,D,E	A,D,E	E,I	E,I	E,I	E,I	E,I	E,I	E,I
Polyethylene all	A,D	A,D	A,D	A,D	A,D,H	A,D,H	A,D,E	A,D,E	A,D,E	E,I	E,I	E,I	E,I	E,I	E,I	E,I

Method A Gas Injection

Method B Traditional Techniques with Manual Listening Stick

Method C Non-Intrusive Acoustic Techniques that is Standard Correlator, Correlating Noise Loggers (Accelerometers)

Method D Intrusive Acoustic Techniques that is Standard Correlator or Correlating Noise Loggers (Hydrophones)

Method E Inline Inspection Techniques (Tethered & Free-swimming)

Method F Noise Loggers (Non-Correlating), Non-Intrusive Magnetic Connection

Method G Electronic Amplified Listening Ground Microphone

Method H Large Diameter mains correlator with accelerometers

Method I Large Diameter mains correlator with Hydrophones

Notes:

1. A large diameter mains correlator responds the same as a standard correlator in all circumstances however its processing power is greater, and the sensors are more sensitive rendering it suitable to be used on the larger diameter or non-metallic mains.
2. Satellite leak detection does not use acoustics or pressure to conduct leakage surveys hence it will work for all pipe materials and diameters.
3. Gas injection will work in most scenarios and is not reliant on pipe material nor pressure however the volume of gas required for large diameter pipes would be such that may not be feasible to use.

Figure 2.1 Main pipelines only – high pressure. (Source: Stuart Hamilton)

2.2 MAIN PIPELINES ONLY – LOW PRESSURE

This matrix is for leakage detection on mains fittings only (no house connections) with pressures less than 10 m head or 15 psi. Fittings are at a minimum distance of 200 m apart and maximum 500 m.

Diameter	mm	75	100	150	200	250	300	350	400	450	500	600	700	800	900	1000+
	Inches	3	4	6	8	10	12	14	16	18	20	24	28	32	36	40+
Material																
Metallic all	A,D	A,D	A,D	A,D	A,D	A,D,E	A,D,E	A,D,E	E,I	E,I	E	E	E	E	E	E
Concrete all	A,D	A,D	A,D	A,D	A,D	A,D,E	A,D,E	A,D,E	E,I	E,I	E	E	E	E	E	E
Asbestos Cement	A,D	A,D	A,D	A,D	A,D	A,D,E	A,D,E	A,D,E	E,I	E,I	E	E	E	E	E	E
GRP	A,D	A,D	A,D	A,D	A,D	A,D,E	A,D,E	A,D,E	E,I	E,I	E	E	E	E	E	E
PVC	A,D	A,D	A,D	A,D	A,D	A,D,E	A,D,E	A,D,E	E,I	E,I	E	E	E	E	E	E
Polyethylene all	A,D	A,D	A,D	A,D	A,D	A,D,E	A,D,E	A,D,E	E,I	E,I	E	E	E	E	E	E

Method A Gas Injection

Method B Traditional Techniques with Manual Listening Stick

Method C Non-Intrusive Acoustic Techniques i.e. Standard Correlator, Correlating Noise Loggers (Accelerometers)

Method D Intrusive Acoustic Techniques i.e. Standard Correlator or Correlating Noise Loggers (Hydrophones)

Method E Inline Inspection Techniques (Tethered & Free-swimming)

Method F Noise Loggers (Non-Correlating), Non-Intrusive Magnetic Connection

Method G Electronic Amplified Listening Ground Microphone

Method H Large Diameter mains correlator with accelerometers

Method I Large Diameter mains correlator with Hydrophones

Notes:

1. A large diameter mains correlator responds the same as a standard correlator in all circumstances however its processing power is greater, and the sensors are more sensitive rendering it suitable to be used on the larger diameter or non-metallic mains.
2. Satellite leak detection does not use acoustics or pressure to conduct leakage surveys hence it will work for all pipe materials and diameters.
3. Gas injection will work in most scenarios and is not reliant on pipe material nor pressure however the volume of gas required for large diameter pipes would be such that may not be feasible to use.

Figure 2.2 Mains pipelines only – low pressure. (Source: Stuart Hamilton)

2.3 DOMESTIC AND MAINS FITTINGS – HIGH PRESSURE

This matrix is for leakage detection on all property and mains fittings with pressures greater than 10 m head or 15 psi. Fittings are at a minimum distance of 10 m apart and maximum 50 m.

Diameter	mm	75	100	150	200	250	300	350	400	450	500	600	700	800	900	1000+
	Inches	3	4	6	8	10	12	14	16	18	20	24	28	32	36	40+
Material																
Metallic all	A,B,C, D,F,G	A,B,C, D,F,G	A,B,C, D,F,G	A,B,C, D,F,G	A,B,C, D,F,G	A,B,C, D,F,G	A,C,D, E,F,G	A,C,D, E,F,G	A,C,D, E,F,G	C,D,E, F,G	C,D,E, F,G,H,I	C,D, E,H,I	C,D, E,H,I	D,E H,I	D,E H,I	D,E H,I
Concrete all	A,C, D,F,G	A,C, D,F,G	A,C, D,F,G	A,D	A,D	A,D	A,D,E	A,D,E	A,D,E	E,I	E,I	E,I	E,I	E,I	E,I	E,I
Asbestos Cement	A,C, D,F,G	A,C, D,F,G	A,C, D,F,G	A,C, D	A,C, D	A,C, D	A,D, E	A,D, E	A,D, E	E,I	E,I	E,I	E,I	E,I	E,I	E,I
GRP	A,C, D,F,G	A,C, D,F,G	A,C, D,F,G	A,C, D	A,C, D	A,C, D	A,D, E	A,D, E	A,D, E	E,I	E,I	E,I	E,I	E,I	E,I	E,I
PVC	A,C, D,F,G	A,C, D,F,G	A,C, D,F,G	A,D	A,D	A,D	A,D, E	A,D, E	A,D, E	E,I	E,I	E,I	E,I	E,I	E,I	E,I
Polyethylene all	A,C, D,F,G	A,C, D,F,G	A,C, D,F,G	A,D	A,D	A,D	A,D, E	A,D, E	A,D, E	E,I	E,I	E,I	E,I	E,I	E,I	E,I

Method A Gas Injection

Method B Traditional Techniques with Manual Listening Stick

Method C Non-Intrusive Acoustic Techniques that is Standard Correlator, Correlating Noise Loggers (Accelerometers)

Method D Intrusive Acoustic Techniques that is Standard Correlator or Correlating Noise Loggers (Hydrophones)

Method E Inline Inspection Techniques (Tethered & Free-swimming)

Method F Noise Loggers (Non-Correlating), Non-Intrusive Magnetic Connection

Method G Electronic Amplified Listening Ground Microphone

Method H Large Diameter mains correlator with accelerometers

Method I Large Diameter mains correlator with Hydrophones

Notes:

1. A large diameter mains correlator responds the same as a standard correlator in all circumstances however its processing power is greater, and the sensors are more sensitive rendering it suitable to be used on the larger diameter or non-metallic mains.
2. Satellite leak detection does not use acoustics or pressure to conduct leakage surveys hence it will work for all pipe materials and diameters.
3. Gas injection will work in most scenarios and is not reliant on pipe material nor pressure however the volume of gas required for large diameter pipes would be such that may not be feasible to use.

Figure 2.3 Domestic and mains fittings – high pressure. (Source: Stuart Hamilton)

2.4 DOMESTIC & MAINS FITTINGS – LOW PRESSURE

This matrix is for leakage detection on all property and mains fittings with pressures less than 10 m head or 15 psi. Fittings are at a minimum distance of 10 m apart and maximum 50 m.

Diameter	mm	75	100	150	200	250	300	350	400	450	500	600	700	800	900	1000+
	inches	3	4	6	8	10	12	14	16	18	20	24	28	32	36	40+
Material																
Metallic all	A,C, D,F	A,C, D,F	A,C, D,F	A,C, D,F	A,D	A,D,E,I	A,D,E,I	A,D,E,I	A,D,E,I	E,I	E,I	E	E	E	E	E
Concrete all	A,D	A,D	A,D	A,D	A,D	A,D,E,I	A,D,E,I	A,D,E,I	A,D,E,I	E,I	E,I	E	E	E	E	E
Asbestos Cement	A,D	A,D	A,D	A,D	A,D	A,D,E,I	A,D,E,I	A,D,E,I	A,D,E,I	E,I	E,I	E	E	E	E	E
GRP	A,D	A,D	A,D	A,D	A,D	A,D,E,I	A,D,E,I	A,D,E,I	A,D,E,I	E,I	E,I	E	E	E	E	E
PVC	A,D	A,D	A,D	A,D	A,D	A,D,E,I	A,D,E,I	A,D,E,I	A,D,E,I	E,I	E,I	E	E	E	E	E
Polyethylene all	A,D	A,D	A,D	A,D	A,D	A,D,E,I	A,D,E,I	A,D,E,I	A,D,E,I	E,I	E,I	E	E	E	E	E

Method A Gas Injection

Method B Traditional Techniques with Manual Listening Stick

Method C Non-Intrusive Acoustic Techniques that is Standard Correlator, Correlating Noise Loggers (Accelerometers)

Method D Intrusive Acoustic Techniques that is Standard Correlator or Correlating Noise Loggers (Hydrophones)

Method E Inline Inspection Techniques (Tethered & Free-swimming)

Method F Noise Loggers (Non-Correlating), Non-Intrusive Magnetic Connection

Method G Electronic Amplified Listening Ground Microphone

Method H Large Diameter mains correlator with accelerometers

Method I Large Diameter mains correlator with Hydrophones

Notes:

1. A large diameter mains correlator responds the same as a standard correlator in all circumstances however its processing power is greater, and the sensors are more sensitive rendering it suitable to be used on the larger diameter or non-metallic mains.
2. Satellite leak detection does not use acoustics or pressure to conduct leakage surveys hence it will work for all pipe materials and diameters.
3. Gas injection will work in most scenarios and is not reliant on pipe material nor pressure however the volume of gas required for large diameter pipes would be such that may not be feasible to use.

Figure 2.4 Domestic and mains fittings – low pressure. (Source: Stuart Hamilton)

Chapter 3

Acoustic principles

As many of the technologies currently used for leak detection involve acoustics, it is important to understand some basic principles of leaks, and some of the general physics involved. The noise characteristics of a leak have been used for many years to locate leaks – listening on valves, hydrants, stop taps, or at the ground surface above the line of the pipe.

3.1 HISTORY OF ACOUSTICS

Many scientists and researchers over the centuries have experimented with sound and acoustic theory in order to discover and formulate solutions relating to a number of practical problems. One of the first people to experiment with underwater acoustics was Leonardo Da Vinci in 1490 and documented his thoughts on discovering that if you are on a ship and bring it to a halt, then place a long tube in the water you will be able to hear by placing your ear on the end of the tube ships that are far away. Isaac Newton subsequently developed mathematical principles which dealt with sound. However, a major step in the history of acoustics was made by Charles Sturm, a French mathematician and Daniel Colladon, a Swiss physicist. Their experiment took place on Lake Geneva in 1826 when they measured the time difference between a flash of light and the sound of a submerged bell. The experiment was a success and the speed of sound measured was 1435 metres per second over a distance of 17,000 metres. This was the first time that a quantitative measurement was carried out and this sound speed value remains within a margin of acceptance of around 2%. Modern acoustic theory was established and documented by Lord Rayleigh in 1877.

Underwater acoustics became extremely important with the start of the World War I with anti-submarine listening systems being developed. A number of echolocation patents were granted in Europe and the United States of America with Reginald A. Fessenden's echo-ranger being patented in 1914. In the same period in France, Paul Langevin and in Britain, A. B. Wood and associates were carrying out similar pioneering work. Active ASDIC (Anti-Submarine Detection Investigation Committee) and passive

SONAR (SOund Navigation And Ranging) were developed during the war, enabling the first large scale deployment of submarines. Acoustic mines were also another great advancement.

The refraction of sound waves produced by temperature and salinity gradients in the ocean were first described in a scientific paper in 1919. The range predictions were experimentally validated by transmission loss measurements.

Applications of underwater acoustics developed during the next two decades after the First World War. In the 1920's, commercial developments included the fathometer, or depth sounder and natural materials were used for the transducers. By the 1930's sonar systems incorporating piezoelectric transducers made from synthetic materials were being used for passive listening systems and for active echo-ranging systems. These were used extensively during World War II by both submarines and anti-submarine vessels.

Advances in the theoretical and practical understanding of underwater acoustics have been aided largely in recent times by computer-based techniques. The methodology applied today to detect water leaks using leak-noise correlators and noise loggers is based on the principles of underwater acoustics.

3.2 PROPAGATION

Water escaping through a leak creates a noise. The sound waves propagate along the pipe wall, fittings, surrounding ground and especially via the water inside the pipe. If the pipe wall were completely rigid, the sound would propagate with a velocity of approximately 1485 metres per second. However, the pipe material is always elastic to some degree. This elasticity causes attenuation of the pressure wave as it progresses down the pipeline.

The sound velocity in water pipes depends on the pipe material and the ratio between the diameter and wall thickness. For metallic pipes, the sound velocity slows down to about 1200 m/s, although the metal absorbs only a fraction of the sound energy and the sound still travels quite far. Plastic pipes are much more elastic, reducing the sound velocity to 300–600 m/s. Furthermore, the sound energy is more easily absorbed causing the sound waves to become weaker and weaker as they travel along the pipeline.

3.3 RESONANCE

Every pipe will exhibit a certain resonant frequency, if only longitudinal sound waves are considered (circumferential resonances will also appear but are of less importance). This resonant frequency is dependent upon the physical dimensions of the pipe and also upon the velocity of sound. It will therefore be particularly low for plastic materials, but also low for metal pipes of larger diameters. It can often be as low as around 10 Hz, which is well outside the perception range of the human ear (20–20 000 Hz in a healthy young person).

3.4 ATTENUATION

Higher frequencies are always attenuated more strongly with distance than lower frequencies. One example can be whales in the ocean, who communicate over enormous distances at subsonic frequencies. Another is distant thunder, which is only perceived as a low frequency rumble. However, even low frequencies are eventually attenuated over long distances.

When a leak noise is attenuated enough, it will be masked by other noises such as traffic, and ambient noises from effects within the pipe (such as turbulence resulting from rough surfaces) until ultimately even an expert cannot discern the leak sound.

Low frequencies are less attenuated and travel farther before they drown in the ambient noise. The snag is that human hearing cannot respond to the lowest frequencies.

The attenuation of a sound wave is small at resonance. Below the resonant frequency, attenuation increases slightly with decreasing frequency, whereas above the resonant frequency attenuation will increase strongly with increasing frequency.

3.5 ACOUSTIC IMPEDANCE

Every material has certain acoustic impedance that is expressed as the product of its density and its speed of sound. If sound is travelling in a certain medium, e.g. water, and meets a medium with different acoustic impedance, e.g. air, part of the sound wave will be reflected back.

If the differences in acoustic impedance are great, almost all of the sound will be reflected. If on the other hand both media have the same acoustic impedance, the sound will travel through the boundary with no reflection. In practice, the studied case lies between those extremes, and reflection will be partial.

The air/water boundary will reflect practically all sound, because both the density and the speed of sound of the two media are so different. The water/steel boundary will also reflect most of an impinging sound, since both the density and the speed of sound of steel are much greater than the corresponding quantities for water.

Chapter 4

Leak detection technologies

There are a vast number of techniques to detect where leakage occurs in the network. Location accuracy depends on many factors, and the subsequent portions of this document provide further detail. Some techniques can approximate or localize the position of a leak while others can detect exact locations. Often a tool-box approach is used, where multiple technologies are deployed.

4.1 METHOD A: GAS INJECTION METHOD

This method uses a gas detector to find the presence of a tracer gas that has been injected into a pipeline. While helium can be used, the most common tracer gas is hydrogen due to its lower cost and high performance.

Hydrogen is the lightest gas and has the lowest viscosity. This makes it easy to fill, evacuate and dissipate. Typically diluted 5% in nitrogen, the gas can be injected into buried and ducted cables, pipelines and also small diameter in-house heating pipes.

The gas injection method can be used to detect leaks in all pipe materials from 75 to 1000 mm in diameter. This method can be used with pipes of greater diameter but for obvious reason a considerable amount of gas would be required. The pipeline can be empty of water or full, however with the pipeline full of water less gas is required to find the leak.

The gas comes to the surface after leaving the leak in the pipe, so the direction of the water flow must be known and the gas should be kept within the pipeline in the area of the suspected leak. This requires the closure of any branches/off takes which may cause the gas to be diluted or transferred away from the pipeline in question. The mixing of the gas with water does not affect the water quality. This methodology can be used in all types of sealed tubes including cables and pipelines. The material has no effect on the gas injected.



Figure 4.1 Manual listening sticks (Source: Stuart Hamilton)

4.2 METHOD B: MANUAL LISTENING STICK

The stethoscope or listening stick has an earpiece and is used to listen to leaks on fittings and to pinpoint the location of a leak. It is a widely used piece of equipment for many water utilities. The material of the listening stick can be metal, wooden or plastic. This technique is dependent on the ability of the engineer to hear the leak and uses no electronic equipment to enhance the sound.

This technique is best suited for use on metallic pipelines between 75 and 250 mm and with pressures above 10 m head (15 psi). The material or pipe size does not prevent the listening stick from being able to pinpoint the leak from the surface, but what does affect this is the type of leak, ground backfill material, pressure of the water leaving the pipe, background noise and the ability of the engineer (Figure 4.1).

4.3 METHODS C AND D: LEAK LOCATION USING ACOUSTIC NOISE CORRELATION THEORY

Leak–noise correlation works by comparing the noise detected at two different points on or in the pipeline. Assuming consistent pipe material and diameter, the noise travels from the leak in both directions at a constant velocity, so that if the leak is equidistant between two sensors then these sensors will detect the noise at the same time. Conversely, if the leak is not equidistant then the sensors will detect the same noise at different times – this difference in arrival times is measured as part of the correlation process. The following diagram illustrates this principle (Figure 4.2).

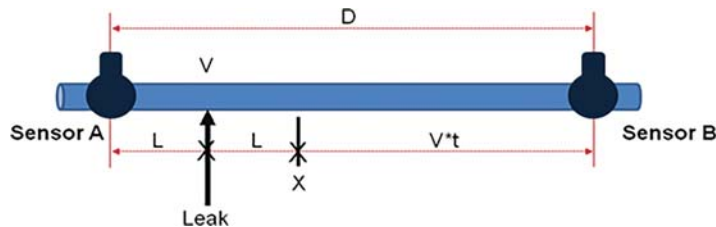

Figure 4.2 Principle of correlation. (Source: Primayer)

The sensors are located at A and B (convenient access points for underground pipes) and as shown the leak position is closer to A. By the time an instance of noise from the leak has reached A, the same noise heading towards B has only travelled as far as point X. The distance from X to B causes a time delay (t) before the noise arrives at B. The correlation processing detects the delay (t) between the arrival of the noise at A and its arrival at B. If the velocity of sound is V and the distance between the sensors is D , then the distance from X to B = $V \times t$. Then

$$D = (2 \times L) + (V \times t) \quad (4.1)$$

This equation is rearranged to give L , the distance from the nearer sensor to the leak position:

$$L = \frac{D - (V * t)}{2} \quad (4.2)$$

Correlation measures the time delay (t). The distance between the sensors must be determined by accurate measurement.

The sound velocity depends upon pipe material, pipe diameter, pipe wall thickness and, to a lesser extent, on surrounding soil. Often theoretical values of sound velocity are used, and this is acceptable for a first approximation of a leak position. However, the velocity will vary due to the above factors, and significantly so if a repair section of a different pipe material exists. Sound velocity must therefore be measured or, alternatively, multiple correlations (between more than two measurement points) carried out.

With all correlation techniques practitioners should be aware that any noise source on the water pipe can result in a correlation peak. All results should thus be treated as 'points of interest' until confirmation typically carried out on site using a ground microphone.

It is important to note that the performance of correlators is dependent on the water pressure and level of background acoustic noise within the network.

Leak-noise correlation requires that the acoustic leak noise signal is detected on or in the water pipeline. There are two types of noise sensor available: accelerometers and hydrophones. These have significant differences in their deployment and performance; they are thus identified as two different methods in the sections below.

4.4 METHOD C: NON-INTRUSIVE CORRELATION WITH ACCELEROMETER SENSORS

When performing correlation using accelerometers the sensors are deployed on pipe fittings or directly to the outside of the pipe, usually by magnetic attachment. No access to the water inside the pipe is required. With radio-based correlators, the accelerometers are positioned on either side of the suspected leak position. Accelerometers respond to acceleration and so tend to be more responsive to higher noise frequencies. Accelerometers are most effective on metallic pipes and tend to be less effective with non-metallic pipes or on large diameter pipes. This is due to both the rapid attenuation of high frequency signals in many non-metallic pipes and the impedance mismatch between the pipe material and the metal fittings normally used to site accelerometers. However, their ease of deployment and low-cost make them an attractive choice.

When used with radio-based correlators the accelerometers have separate sensors connected via a cable to the radio transmitters or directly to the correlator processor. When accelerometer sensors are used with



Figure 4.3 Examples of separate accelerometer sensors, as used with radio-base correlator and accelerometer integrated into correlating logger shown in lower picture. (Source: Primayer)

correlating logger technology, they are integrated into the waterproof housing and attached via a magnet, as illustrated in [Figure 4.3](#).

4.5 METHOD D: CORRELATION USING HYDROPHONES

Leak location on plastic pipes and in large diameter pipes is difficult because they become more elastic as the pipe material gets softer, or the ratio of pipe wall thickness to overall diameter increases. This results in more rapid absorption of leak energy into the pipe material and surrounding soil, with resultant attenuation as distance from the leak increases. Furthermore, as the leak noise travels, the higher frequency leak noise energy is absorbed much more rapidly than low frequency energy.

Accelerometers placed on the outside of the pipe detect the energy lost into the pipe wall. The water-borne wave is detected directly by hydrophones placed into the water at convenient fittings such as fire hydrants. Combined with advanced filtering technology, particularly at very low acoustic frequencies, hydrophone-based acoustic correlation techniques are beneficial in locating leaks in difficult situations ([Figure 4.4](#)). These situations are likely to occur in the following:

- Large diameter or trunk mains
- Plastic pipes
- Pipes with large distances between available pipe access points
- When high acoustic background noise exists, often due to traffic, etc.

Example of results: [Figures 4.5](#), [4.6](#) and [4.7](#).



Figure 4.4 Example hydrophone installations. (Sources: Primayer (top left), Gutermann (top right) and Primayer (bottom))

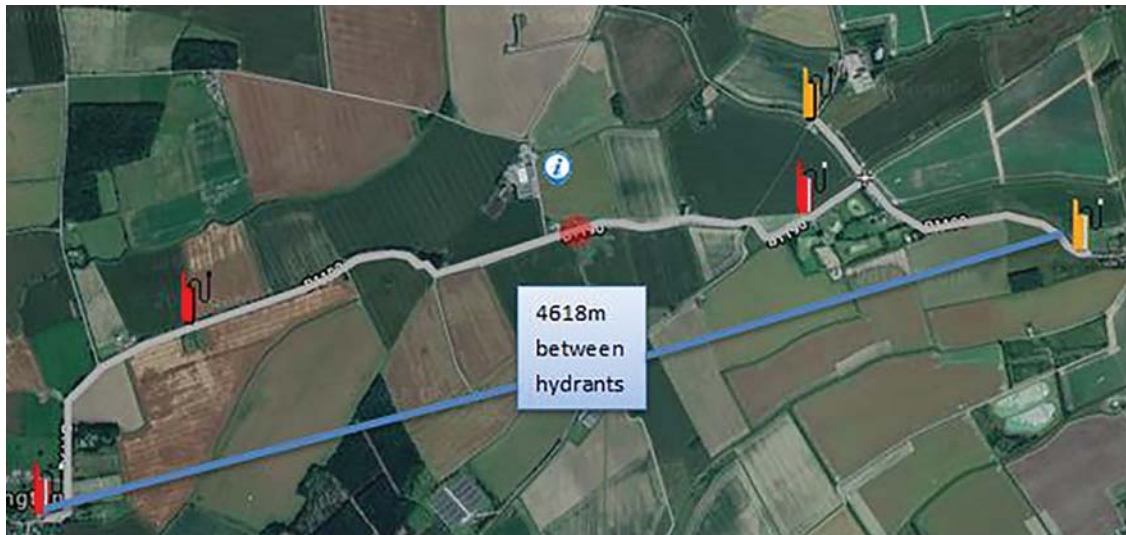

Figure 4.5 Example results of remote correlating logger + hydrophone sensor showing result over long distance. (Sources: Anglian Water, Primayer; Courtesy of Google Maps™)

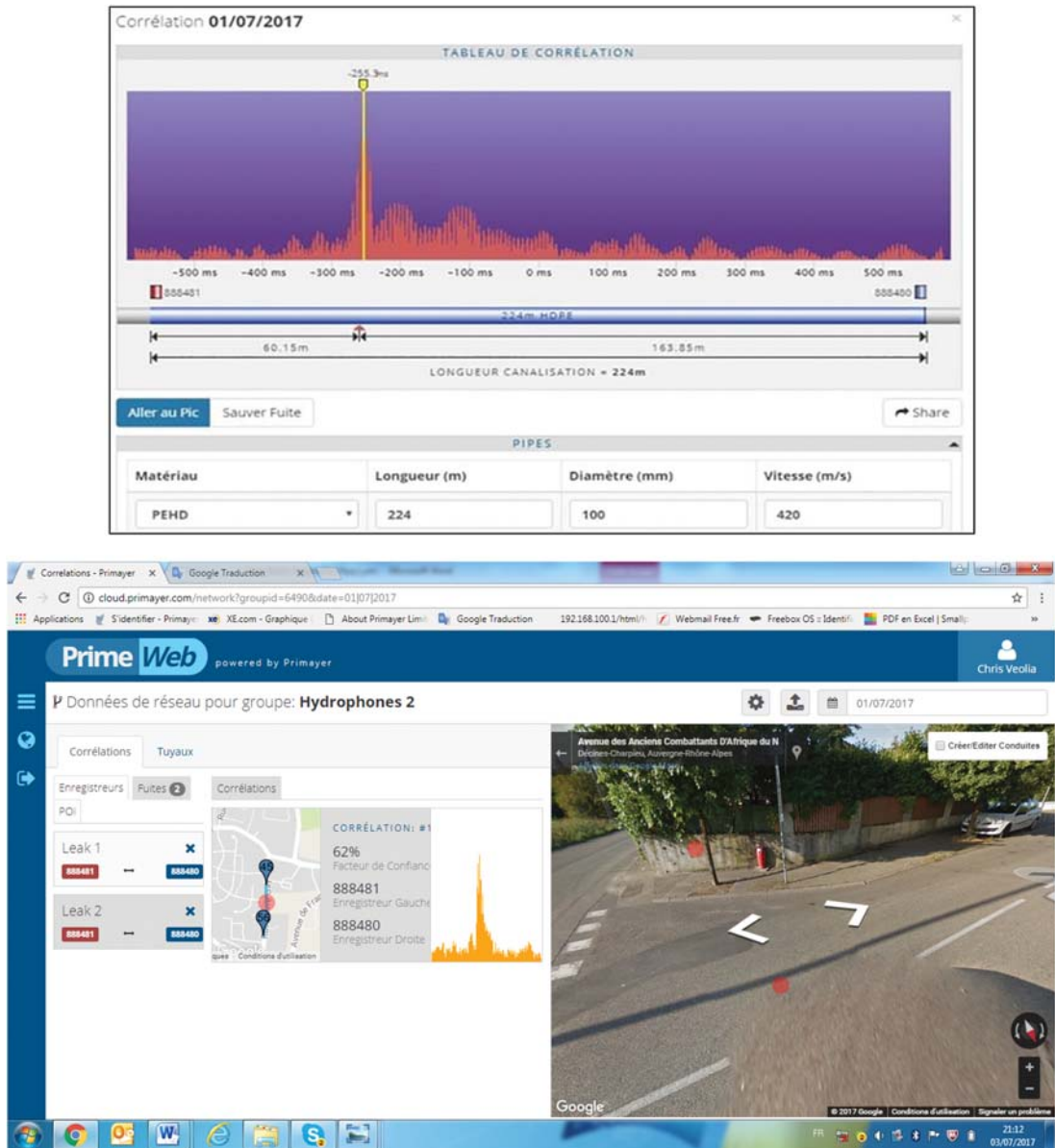

Figure 4.6 Remote correlating loggers with hydrophone sensors showing leak location result on HDPE pipe over a distance of 224 metres. Leak position shown on Google Maps Street View™ (pink dots) to aid management of repair activity. (Source: Primayer)

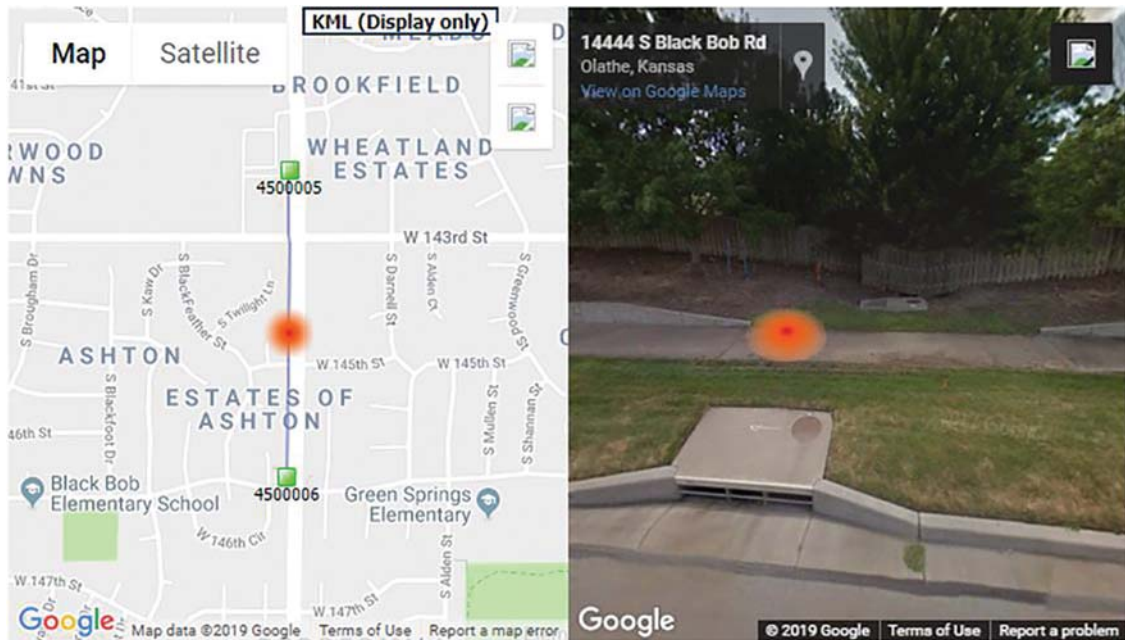

Figure 4.7 Example results of remote correlating logger with hydrophone sensors showing result. (Source: Gutermann; Courtesy of Google Maps™)

4.6 TECHNOLOGIES FOR LEAK NOISE CORRELATION

4.6.1 Correlating loggers with remote communications via radio or cellular networks

This model of correlating noise logger includes remote communications and typically transmits an acoustic sound sample every day. The acoustic sample is recorded by multiple loggers at the same time; usually at night when background acoustic noise is lower. The remote communications are either radio based or utilise cellular networks.

The acoustic data samples are transmitted to a server where multi-point correlation is performed between all loggers. Very accurate time synchronisation must be performed every day to provide accurate leak positions.

Correlating noise loggers are typically deployed in underground chambers. Those using radio communications often require radio transmitters above ground whereas those utilising cellular networks typically do not require above ground technology, dependent upon signal conditions and how the time synchronisation is executed.

Importantly correlation processing (rather than only leak listening) is used for both leak detection and location. Correlation is a more sensitive tool than simple leak listening and enables more leaks to be detected. With accurate time synchronisation the immediate identification of the leak location provides the opportunity to greatly reduce the leak run time.

The acoustic data samples include an audible recording which could be listened to by the user thus helping to confirm if it is a noise from a leak. Furthermore, multi-logger correlation can be performed for better leak location accuracy. In this mode of operation there is no need to know the sound velocity. The



Figure 4.8 Remote correlating logger installation. (Sources: 1 and 2 – Anglian Water/Primayer; 3 – Gutermann)

leak position results are typically accessible on any device with internet access. Logger positions can be shown on *Google Maps* (Figure 4.9, courtesy of Google Maps) together with *Street-View* visualisation (Figure 4.10) of the leak position which is of great help to the leakage and repair teams (Figures 4.11 and 4.12). In addition, historical data can also be made available.

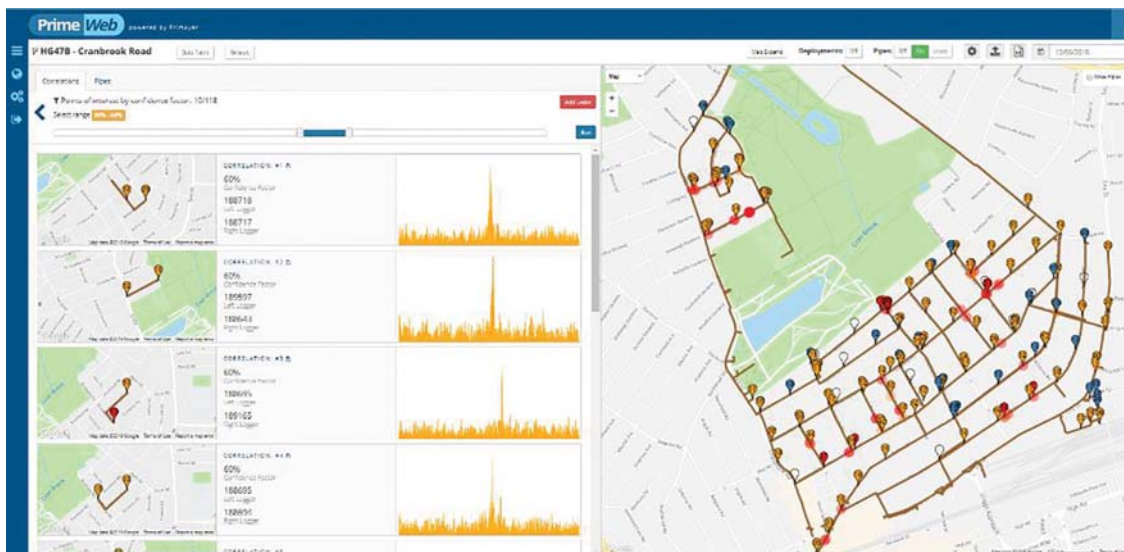

Figure 4.9 Dashboard view displaying correlation thumbnails plus the loggers and multiple leak positions. (Source: Primayer)

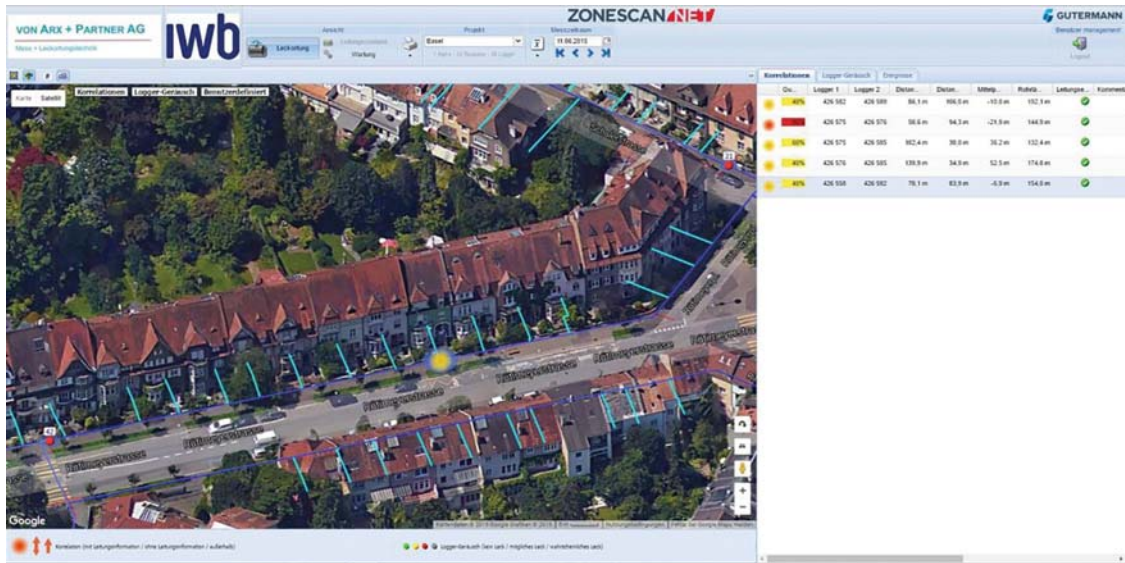

Figure 4.10 Correlated leak position on “T” indicating a leak on the service connection or inside the house. (Source: Gutermann)

Advantages

- Leak positions provided without need to visit sites
- Daily data gives reduced leak run time
- A leak may be detected by multiple loggers overcoming the need to know the sound velocity enabling accurate leak position
- Simple installation (when communications is cellular based)
- Data available at any location via web browser
- Leak listening for confirmation of leak noise
- Acoustic data sampled at night when optimum acoustic conditions exist.

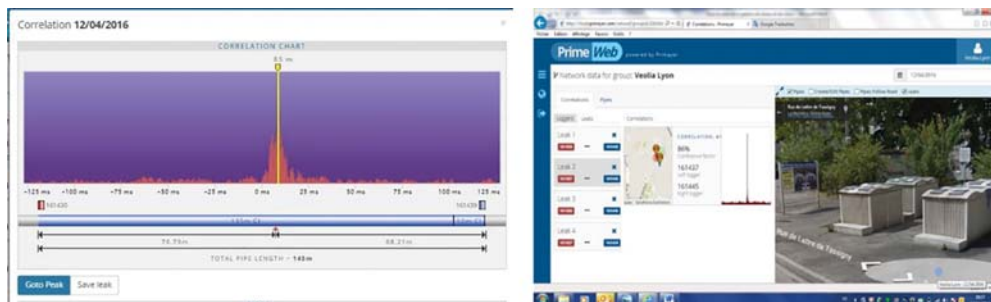

Figure 4.11 Correlation result with position marked (*Street-View* position was confirmed). (Source: Primayer; Courtesy of Google Maps™)



Figure 4.12 Excavation and leaking pipe exposed. (Source: Primayer)

Disadvantages

- Will locate constant ‘non-leak’ noises, such as consumer use.
- When above ground radio transmitters are used they sometimes are difficult to deploy in busy urban streets. (This is a much-reduced problem when below ground cellular communications are used.)
- Use of stored, theoretical, velocity values can give erroneous results. However, correlations between multiple loggers overcomes this problem.
- Limitations of radio range. Radio range can vary greatly depending upon proximity of local buildings and weather conditions. This only becomes a problem when working over long distances with limited access points.

4.6.2 Correlating loggers for on-site leak location – manual download

Variants of the correlating loggers detailed in above are available but without remote communications having multi-point correlation for on-site data collection. The example below shows the location of eight leaks using eight correlating loggers on a PVC pipe network for which 28 correlations were produced and sorted based on the degree of ‘confidence’.

The distance between adjacent loggers and pipe material details need to be entered in all loggers. In case a correlation ‘run’ is carried out without entering these data first then only those logger pairs with a correlation result require entry of these details. Correlation details could easily be entered on a map or pipe schematic.

Advantages

- Correlation can be pre-programmed and thus usually carried out at night when ideal acoustic conditions exist, because water pressure is higher (assuming no pressure control) and thus leak noise propagates much further; and background acoustic noise is lower
- Multiple correlations carried out (at typically one-hour intervals) to clearly separate consumer use from (continuous) leak noise
- One leak may be detected by more than two loggers thus allowing accurate location, without need to measure the velocity of sound
- As loggers are deployed at multiple points along a pipe or network, multiple leaks may be located (assuming they exist)
- Improved sensitivity when detecting low level (difficult) leak noise
- Operating distance not limited by radio transmission range.

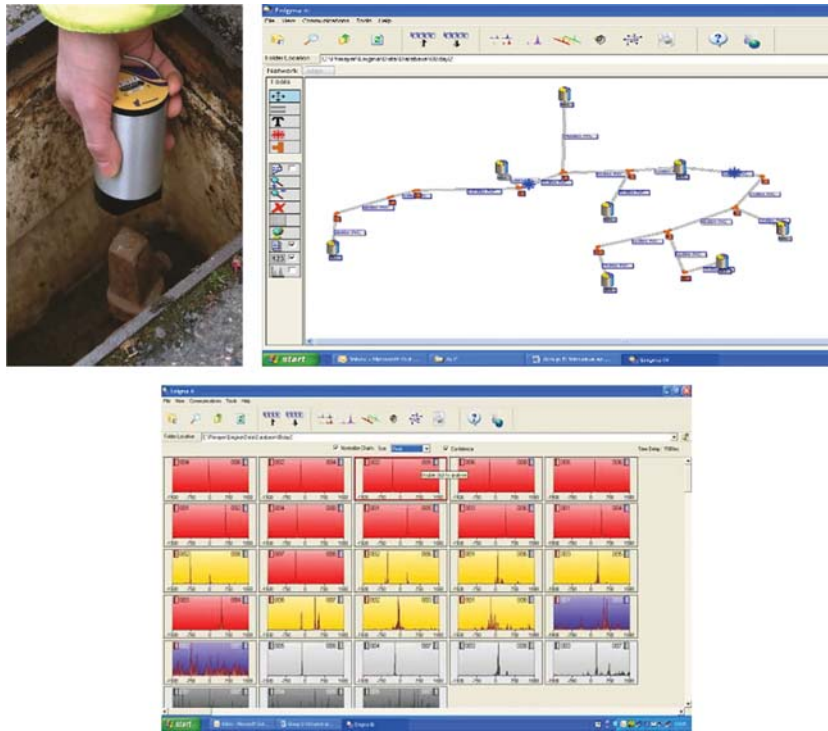

Figure 4.13 Correlating loggers on a pipe schematic together with resultant correlations. (Source: Primayer)

Disadvantages

- Slower to use than radio-based correlation, especially if deployed overnight
- Will locate constant 'non-leak' noises.

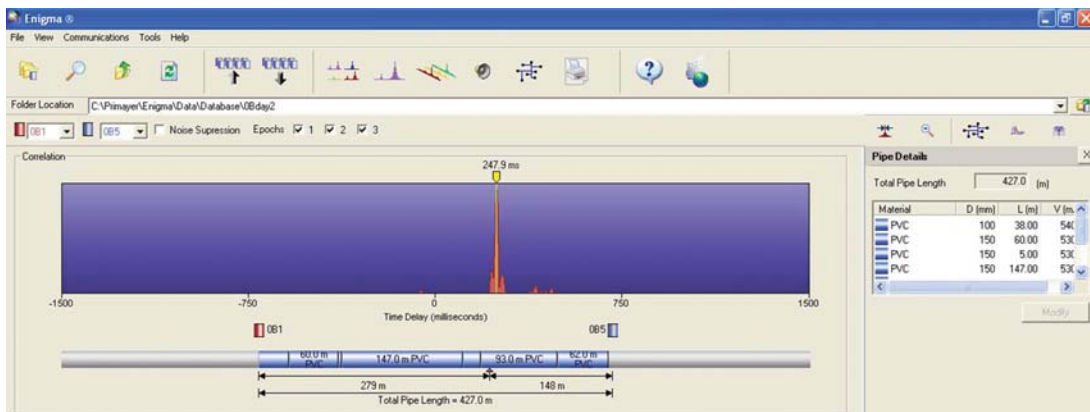

Figure 4.14 Example of results from Figure 4.13 on PVC pipe with leak located over 427 m. (Source: Primayer)

4.6.3 Radio-based correlator (for on-site leak location)

The sensors (accelerometers or hydrophones) are deployed on hydrants or similar available fittings or pipe access points. The sensors are positioned on either side of the suspected leak position and the noise created by the leak is detected by the sensors. This leak noise data is transmitted via a radio transmission to the correlation processing unit.

The system typically consists of: a correlator processor unit or laptop computer with correlation software; accelerometer or hydrophone sensors; radio transmitters; radio receiver unit; headphones; and a battery charger (Figure 4.15).

Correlation processing and presentation of results varies greatly between manufactured products. All products will require the entry of distance between sensors plus details of pipe material (to estimate the velocity of sound). Most will also allow entry of user-defined material/velocity values (Figure 4.16).

For optimum performance, when detecting low level leak noise, the complete correlation system design is optimised to reduce inherent electronic noise. Systems for these applications will also have a very low frequency response, capable of operation from a few Hertz upwards. A variety of advanced filtering techniques are available to further enable a correlation result to be successful. These may be applied during on-site correlation processing and during post-processing (back in the office): (a) Manual filters – allow the operator to set filters based upon experience; (b) Auto-filters – these scan the received signals and automatically determine one, or more, filter band for optimum correlation; (c) Coherence – Coherence Function is a computed value that gives a measure of the similarity between the two leak noise signals as a function of frequency.

Advantages

- Gives good results in many situations
- Two-point radio-based correlators are generally fast to deploy and give rapid results whilst on-site
- If a correlation result is not achieved, then the opportunity exists for deployment at alternative pipe fittings
- Digitally recorded sounds can be further processed off-site.

Disadvantages

- Radio transmitters are sometimes difficult to deploy in busy urban streets when traffic disruption occurs

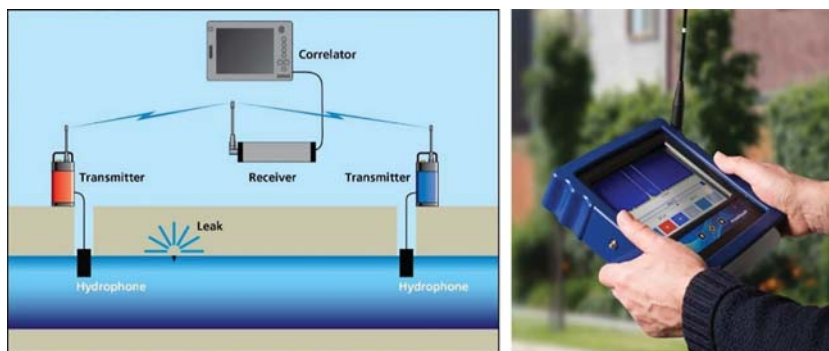

Figure 4.15 Radio-based correlator system. (Source: Primayer)

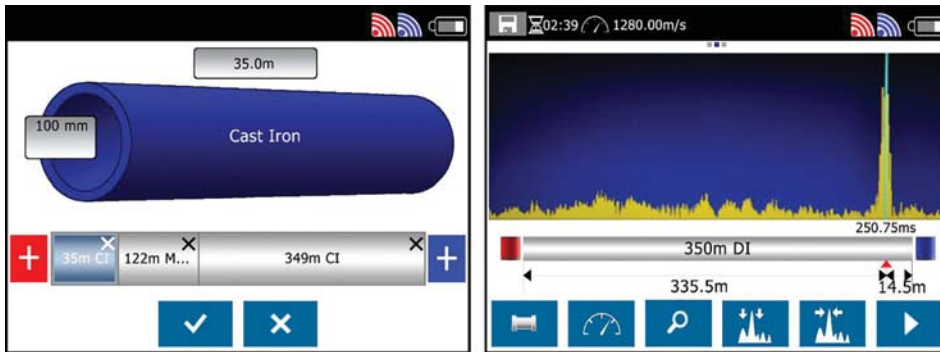

Figure 4.16 Display showing touch-screen operation regarding input of pipe details together with correlation function result on ductile iron pipe over 350 m. (Source: Primayer)

- Will detect consumer use and non-water noises
- Use of stored, theoretical, velocity values can give erroneous results
- Limitations of radio range. Radio range can vary greatly depending upon proximity of local buildings and weather conditions. This only becomes a problem when working over long distances with limited access points.

4.6.4 Potential sources of error in correlation leak location

4.6.4.1 Knowledge of the pipe network

A thorough knowledge of the layout of the pipe network is required to ensure that the correlator is making measurements on the correct section of pipe. Where any doubt exists then the pipe must be traced using pipe location equipment. If there is any error in the location of the pipe, resulting in the incorrect distance between sensors being entered then this will result in an erroneous leak position (dry hole).

If the leak is located outside the length of pipe between the sensors, then the correlator will ignore the transit time from the leak to the nearest sensor, as this transit time will be the same for both sensors. This will give the result that the leak will appear to be located directly at the sensor nearest to the leak. This is often termed 'out-of-bracket.' (Figure 4.17). In this situation a sensor must be moved towards the leak to continue the leak location exercise.

If there is a leak on a pipe that connects to the main pipe, then the leak noise will appear to spread from the point of connection and so will appear as a leak at that point. In this situation it is necessary to move one

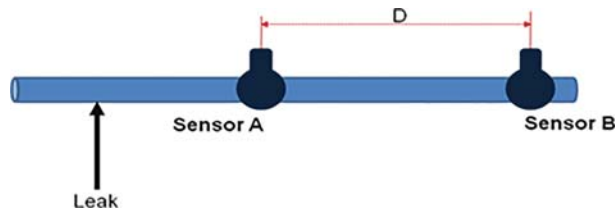

Figure 4.17 Out-of-bracket leak. (Source: Primayer)

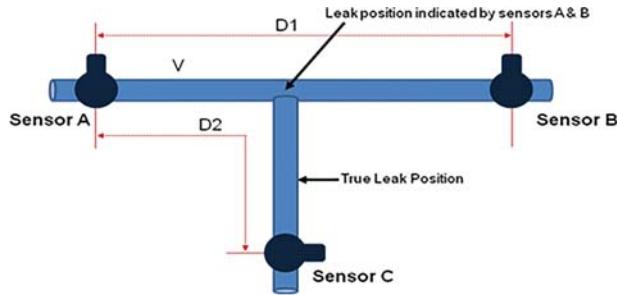

Figure 4.18 Leak on connecting pipe. (Source: Primayer)

sensor to the connecting pipe (and so place the leak between the sensors) to locate the leak accurately. Figure 4.18 shows a schematic for this situation.

4.6.4.2 Locations of non-leak noises

Correlation will give a location for any noise generating frequencies within the bandwidth of the correlation system. Non-constant noise, such as consumer water use, can be a cause of misleading results. When using a

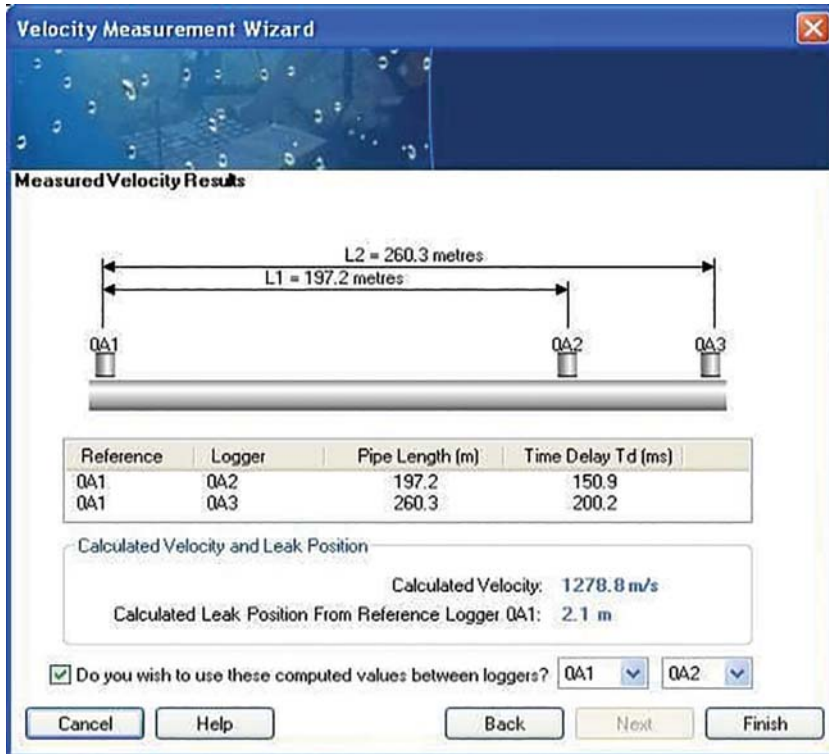

Figure 4.19 Velocity measurement with two correlation runs. (Source: Primayer)

radio-based correlator the operator must have sufficient skill to identify consumer use and repeat the correlation exercise some time later to eliminate this possibility. Correlating loggers separate non-constant noises from constant noises by performing several correlations separated by typically one hour to ensure the noise source is always present (a characteristic of leak noise). Correlation will also give the location of constant non-leak noises such as noises generated by pumps, mechanical meters, PRV's turbulence at bends, etc. Again, training of operators is important to be able to identify these as non-leak noise sources.

4.6.4.3 *The sound velocity problem*

The accuracy of leak–noise correlation is highly dependent upon the value of sound velocity used. If the leak is equidistant from both sensors, then the leak-position result is unaffected by the velocity. The error in leak position, due to use of incorrect velocity, increases as the leak position becomes closer to either sensor and this is often the largest single reason for dry holes. On plastic pipes and on large diameter mains the sound velocity varies much more from the theoretical values (as compared to the variation on smaller diameter ferrous mains). Use of an accurate velocity value is also important when working over longer distances on all pipe materials.

All correlators will store theoretical values and these are the values used on a first correlation run. It is very strongly recommended that:

- (a) The velocity of sound is measured by introducing an artificial noise (such as opening a fire hydrant). This noise can either be between the sensors or, an out-of-bracket noise. There may be difficulties in finding a suitable noise source or in detecting it given that the leak noise is also present.
- (b) Carry out multiple correlation runs (on the leak). This is illustrated in [Figure 4.19](#) (in fact it simply gives a more accurate leak position and the value of velocity is given as a by-product). Multiple correlation runs are carried out and the distance between sensors must be correctly entered before commencement. This can easily be done between correlation loggers already deployed.

Chapter 5

Method E: In-line leak detection techniques

Specifically designed for large diameter transmission pipelines, in-line leak detection technologies can overcome some of the challenges relating to sound propagation in increasing diameters and discriminate between multiple leaks in a single length of pipeline. Pipelines can be inspected while they remain under normal operating conditions, meaning there is no disruption to the customer water supply. A comprehensive disinfection process occurs prior to equipment deployment, making it suitable for potable water applications.

There are two types of in-line systems: tethered and free swimming. Both have their advantages and limitations, but in both cases an acoustic hydrophone passes directly beside leaks allowing for leaks of all sizes to be detected irrespective of the pipe material. Leaks as small as 0.2 litres per minute have been detected by in-line technologies and since they do not rely on sound propagation through either the water column or pipe wall, systems are proven to be very sensitive, even for very small leaks.

5.1 TETHERED SYSTEMS

Tethered leak detection technologies operate by deploying a hydrophone into the pipeline to be inspected while it remains under normal operating conditions. The hydrophone is connected to a signal processing and display unit via an umbilical cable which can be up to 2 kilometres in length. The hydrophone traverses the pipeline pulled by the flow of water acting on a drogue (parachute) attached to the front of the hydrophone and cable. The hydrophone location along the pipeline length can be controlled by an above ground operator. As the hydrophone passes any leak on the pipeline, the above ground operator hears the unique acoustic signature created by the leak, and sees it visually on a frequency spectrum monitor, and can position the hydrophone so it is directly aligned with the leak. At this point, a second above-ground operator can locate the hydrophone through the ground surface and pinpoint the leak and mark it with appropriate methods. The tethered leak detection technology also has an odometer so there is an understanding of deployment length but given the nature of horizontal and vertical bends along the



Figure 5.1 Tethered system access through 48 mm or above connection and only goes with the flow. (Source: Pure Technologies and JD7)



Figure 5.2 Push tethered system which can be operated with or against the water flow with access through tapping point or fire hydrant. (Source: JD7 Ltd)

inspection length it is important to locate each leak with the above ground device (where possible and not restricted due to access).

Once the sensor is sited at the leak, the position of the sensor can be determined using a locating system mounted in the sensor head. A second operator can track the position of the sensor head during deployment using this locating device giving an accurate indication of the sensor location and pipe track. Having pin-pointed the position of the sensor, the exact location of any leak can be marked on the ground over the pipe (Figure 5.1).

Tethered technologies are best suited to work in relatively straight pipelines where deployments of up to 2 km from a single insertion point are possible; other constraints may restrict the length that can be surveyed from each insertion point. Careful planning of the work will maximise the distance that can be surveyed. The most recent versions of tethered leak detection technologies can traverse up to 270 degrees of cumulative bends per insertion before friction on the cable is too great.

Most tethered technologies have live video capability, allowing the asset owners to collect additional data sets and asset intelligence from a leak detection survey. This may include identification of valve status, cement-lining delamination, tuberculation or unknown tappings.

Tethered systems are typically deployed through existing tappings on the pipeline (such as air valves, flowmeter locations, etc.) or new tappings can be created. These are usually 50–100 mm in diameter. Tethered systems that can access the main through fire hydrants are also available, but limitations may exist with regards to length inspected (Figure 5.2). Alternative sensors, including video and ultrasonic pipe-wall inspection, are also available.

5.2 FREE SWIMMING SYSTEMS

Free-swimming leak detection technologies are also available. These devices are inserted into a live pipeline and are propelled along the pipeline by the water flow. At the end of the inspection, a net is used to catch and extract the system from the pipeline, while the pipeline remains under normal operating conditions (Figure 5.3 and Figure 5.4).

An acoustic recording is made during the entire inspection and tracking information is collected at intervals throughout the inspection. Leaks are identified during data analysis following the removal of the system from the pipeline.

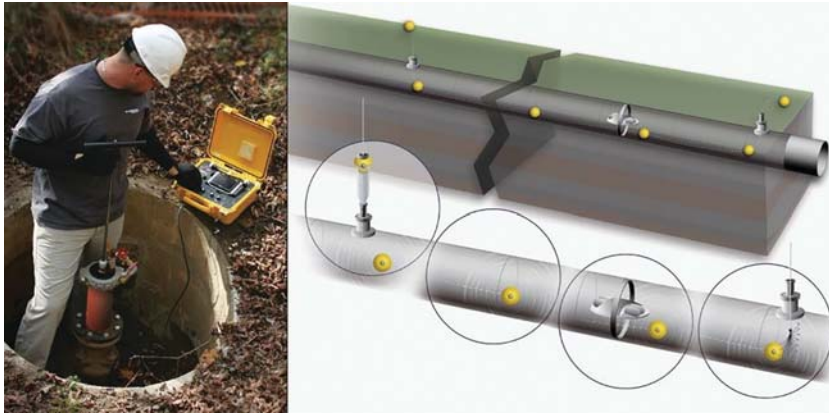

Figure 5.3 Free-swimming sensor deployment schematic. (Source: Pure Technologies)

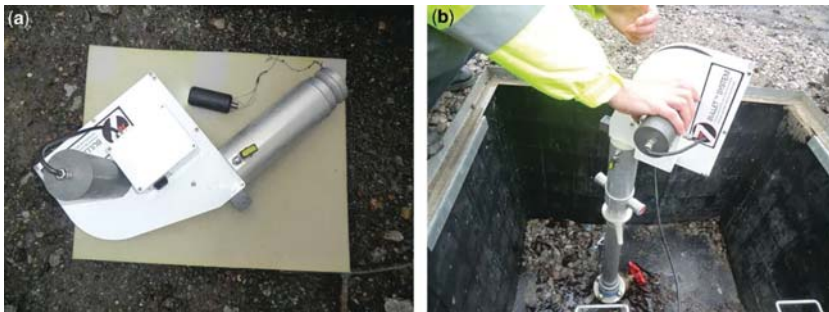

Figure 5.4 (a) Free flowing device combined CCTV, acoustic head, tracking device and launch tube. (b) Free flowing device launched into main. (Source: JD7 Ltd)

The free-swimming leak detection technology consists of the following components: (a) an acoustic sensor and other sensors, including acoustic transponder, data processor, temperature sensor, pressure sensor, gyroscope, magnetometer, memory device and batteries; (b) above-ground tracking devices (which are used to track the progress of the system as it moves through the pipeline); (c) insertion equipment; (d) retrieval equipment; (e) analysis software.

The maximum length of pipeline that can be surveyed is determined by the flow rate in the line. For instance, with a flow rate of 1 m/s and a maximum operating life of 18 hours, systems can survey 64 km from a single insertion point. The technology can traverse around tight bends and through inline valves, including butterfly valves, without issue.

The on-board instrumentation allows the velocity of the system at all points along the inspection route to be calculated during post-processing. This, combined with the use of above ground tracking devices, allow for the accurate location of any leaks. The magnetometer onboard the device allows the operators to see changes in the magnetic field strength throughout the inspection and assists with location accuracy.

Chapter 6

Method F: Noise loggers – non-correlating

Previous sections show how noise is created by a leak and propagates through a pipe. Leak noise loggers are designed to “pick up” this leak noise by being placed on available fittings, usually with a magnetic coupling (Figure 6.1).

The leak is identified by each logger unit individually based on the noise signature of a leak being consistent and loud against the background noise. Typically, measures of noise and consistency together



Figure 6.1 Noise logger schematic. (Source: Halma Water Management)

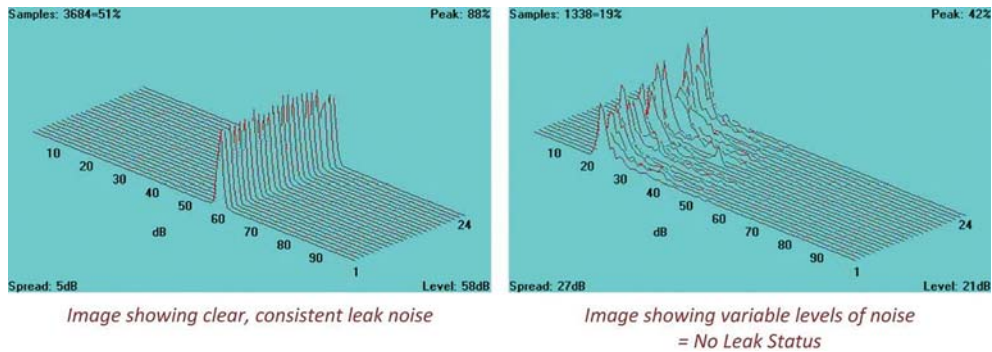

Figure 6.2 Typical leak/no leak display. (Source: Halma Water Management)

with a graphical representation are supplied to the operator. The leak position is “localised” to being between two loggers for follow up pinpointing. The objective is to survey large areas at low cost to maximise efficiency in an active leak detection strategy (Figure 6.2).

Loggers are usually programmed to log during the middle of the night where interfering noise (traffic, legitimate water usage, etc) is at a minimum and leaks can be most easily “heard”. Exact sampling regimes vary across the available systems.

Early systems were manually programmed and downloaded with the operator determining whether or not a leak was present from data supplied. As mass deployment evolved the need to further automate and ease the process became apparent with the objective being to survey large areas quickly and “automatically” at low cost.

To the above end units with radio download and automatic leak determining algorithms were introduced in the early 2000’s. Many such systems are now available. Unit cost has reduced drastically with volume and technological evolution and units are now deployed in large numbers with rapid cost effective surveys possible.

Multiple deployment methodologies have evolved to suit operating requirements as follows: direct download; drive-by patrol; lift and shift; and permanent installation. Each of these is described in the following sections.

6.1 DIRECT DOWNLOAD

Usually where smaller numbers of loggers have been installed and require manual download. This is commonly used where a specific problem is being investigated and the loggers will be removed after the problem has been located.

6.2 DRIVE BY PATROL

Loggers with a radio download facility are placed on site and their download device vehicle mounted for rapid drive-by sweeps of an area. This can be used in two ways.

6.2.1 Fixed

Where an area has the need for frequent surveys the loggers are left in place for immediate survey whenever required. In some instances thousands of units are deployed in this mode, particularly where leakage is being targeted in “open” networks where flow base zones (DMA’s) are not in place.

6.2.2 Survey

Loggers are deployed in an area (often a problematic DMA) so that it can be surveyed and brought under control. Interestingly, experience shows that several sweeps are required to optimise leakage as initial sweeps reveal leaks that are masking larger, quieter leaks that are identified by subsequent downloads after initial leaks are repaired. When all leaks have been identified the loggers are moved to a new target area.

6.3 LIFT AND SHIFT

In order to survey very large areas quickly the industry has developed a “lift and shift” methodology where large numbers of loggers are moved daily. Data is downloaded automatically to handheld retrieval units via radio from which the leak list is transferred directly or remotely to a central office analyzing station for leak pinpointing follow up. Technology has evolved to suit the application of with GPS positioning, mapping and other aids enabling a highly efficient operation to be carried out (Figure 6.4).

Latest developments include apps to act as the programming and download device which takes advantage of third party technology to provide a number of benefits such as GPS location of the sensors and the point of interest, free offline-maps, remote upload of the measurements from site via cellular technology or WiFi, deployment photographs and reports made and uploaded remotely (Figure 6.3).

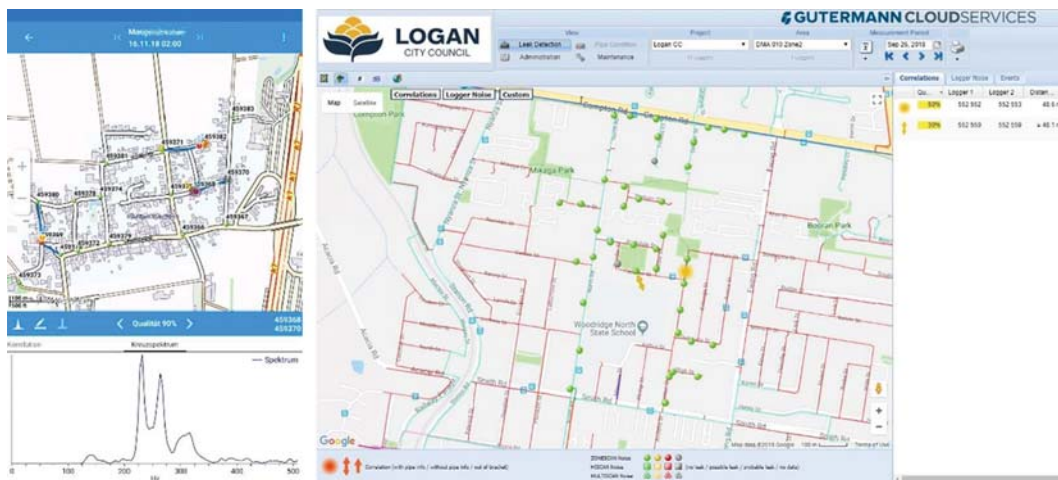

Figure 6.3 App for lift and shift correlation with upload function, cloud software to store and display individual measurements. (Source: Gutermann)

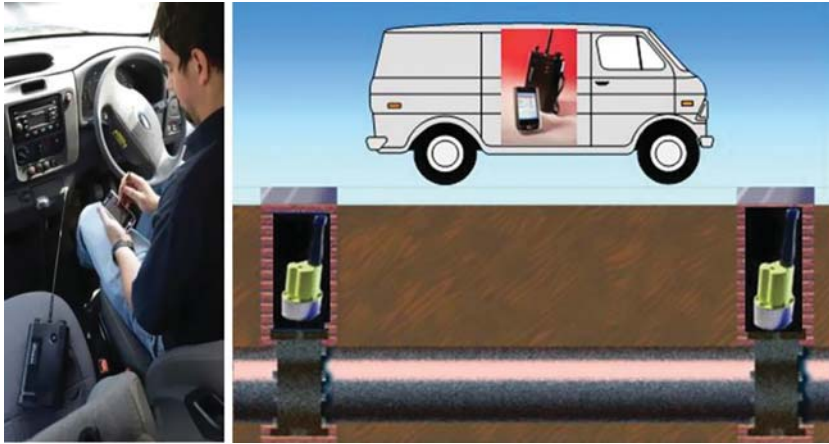

Figure 6.4 Drive-by patrol. (Source: Halma Water Management)



Figure 6.5 Lift and shift deployment and GPS mapping function. (Source: Halma Water Management)

The latest lift and shift noise loggers can also record leak noise when a leak is identified by noise logging. This data can be correlated locally or transmitted along with noise logging data for correlation by cloud-based viewing systems.

Technology has evolved to suit the methodology with GPS positioning, mapping and other aids enabling a highly efficient operation to be carried out (Figure 6.5).

6.4 PERMANENT INSTALLATION

Modern communication technology (SMS, GPRS, 3G, 4G, NBIoT, Radio) and the reducing costs of data transfer now means that noise logging can be economically installed as a field network. Tens of thousands of units have been permanently deployed in recent years. Various data transfer methodologies are available and common download platforms with AMR systems have also been introduced.

The following areas are particularly suitable for permanent installation: areas with a high burst frequency; areas that are traditionally difficult to survey (i.e. town centres and main roads); areas with no DMA structure in operation where acoustic noise logging offers a cost-effective alternative; and previous DMA “hotspots” where ongoing survey is required to ensure leakage levels remain manageable.

Leak noise data is automatically transferred to the central monitoring station. For ease of running, data is often linked with GIS or mapping systems, to provide a quick pictorial overview of the network (Figure 6.6).

The availability of immediate alarms reduces leak run time to a minimum and, with effective follow-up repair, provides a huge dividend in water saved.

The latest system transmit noise files for leaks in addition to logged data. This is used to correlate through cloud platforms providing the leak position. This can be combined with integrated GIS maps to provide ‘autocorrelation’ where leaks are identified through noise logging and automatically ‘correlated’ to give the leak position using data drawn from the GIS system.

Combining leak alarms with DMA flow data enables effective leak sizing to prioritise and optimise follow up activity. Survey labour expense is removed with leak detection becoming a more specialised pinpointing and repair activity.

The benefits of the fixed network approach are evident. With technology providing ease of installation the decision to deploy (or not) is now largely down to an economic comparison of labour costs against capital investment, and the additional savings and benefits of immediate notification.

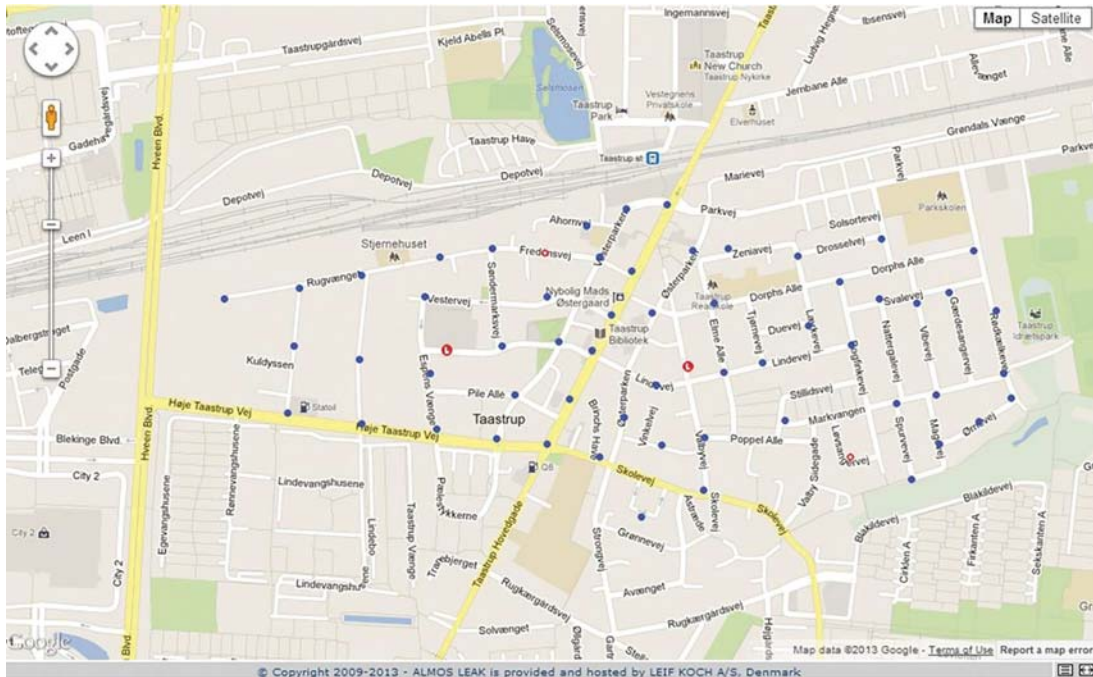

Figure 6.6 Permanent noise logger installation by street map only or full aerial view. (Source: Halma Water Management)

6.5 NOISE LOGGER PRINCIPAL OF USE

Leak noise logging has evolved in scale and technology to provide multiple methodologies for leak localisation. Consideration of labour costs, rate of intervention required, status of the network and availability of DMA's (flow zones) will allow strategy of deployment to be optimised (Figure 6.7).

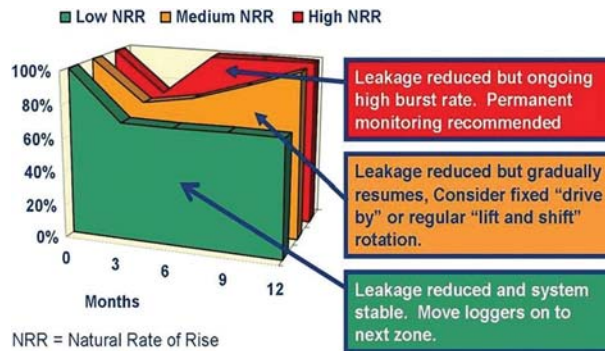

Figure 6.7 Theoretical model for leak noise logging methodology selection. (Source: Halma Water Management)

Chapter 7

Method G: Electronic amplified listening devices

When a pressurised water pipe develops a leak the water flows out into the surrounding ground at high speed, which causes the pipe and soil to vibrate at the exit point. This sound, or vibration, is transmitted by the pipe (structure borne), the surrounding material (ground borne) and through the water itself over a range of frequencies. Careful application of leak detection techniques will enable the operator to eliminate detected noises generated by poor pipeline design or consumer usage and to identify leakage due to pipe system damage.

In addition to being transmitted along the pipeline (both through the water and the pipe wall) the leak noise is transmitted into the ground around the pipe. The noise travels much better through “hard” materials so that the noise travels much further along metallic pipes than asbestos cement pipes which themselves are better than plastic pipes. Ground material generally provides a poorer travel path than the pipeline itself. However, usually some noise transmitted the short distance to the surface. Soft sandy ground provides a worse travel path than well compacted ground with a hard paved surface covering (Figure 7.1).

Factors producing good quality leak noise include high water pressure, hard backfill, a small rupture, clean pipes, metallic pipes and small diameter pipes. By contrast, factors producing poor quality leak noise include low water pressure, soft backfill, split mains, encrusted pipes, soft/lined pipes and large diameter pipes.

Since “leak detection” began, operators have been “listening” for this leak noise using mechanical devices. Traditional listening sticks for detecting water leaks rely on only one of the user’s senses – hearing – the experience and skill of the operator is paramount and, at best, users are only ever able to detect leaks that produce loud noises.

However, it must be noted that not all leaks produce a noise audible to the human ear. Contrary to common perception it is not always the largest leaks which are the loudest; often a large split in a water pipe will produce a less clear noise than a small hole. This can be particularly true in P.V.C., P.E. and M.D.P.E. pipe materials. For this reason amplifying the noise with an electro acoustic microphone is

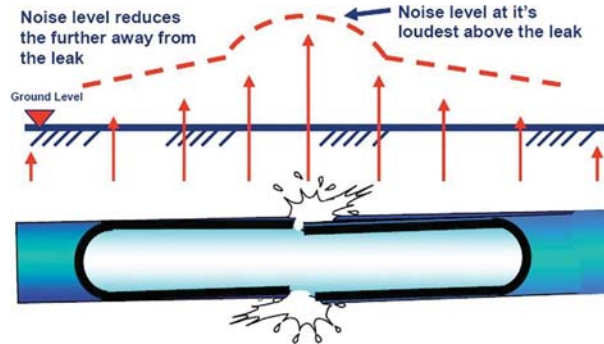

Figure 7.1 Schematic showing propagation of leak noise through ground. (Source: Halma Water Management)

becoming increasingly important to find leaks particularly in networks where these materials are increasingly used.

Modern electronics therefore provide the benefits of advanced sensor technology amplification and filtering to undertake this operation more effectively.

7.1 OPERATIONAL PRACTICE

The typical key components of a modern electronic amplified listening device are shown in [Figure 7.2](#) below:

Pinpointing a leak position using an electronic amplified listening device involves a process of comparing a number of leak noises. To begin with, the operator must select the most suitable sensor device: the microphone foot for hard ground surfaces or the hand probe for soft ground.

To operate the ground microphone safely and effectively, the operator must adjust the headphone volume control to a comfortable listening level. Once the noise has been heard, the headphones should be muted before moving the microphone foot or hand probe to the next test position.



Figure 7.2 Components of electronic amplified listening device. (Source: Halma Water Management)

The operator should repeat the sequence to listen to each of the test locations as he moves along the pipe route in the direction where signal strength is increasing. If the leak noise level falls he has passed the leak and should go back and reduce the distance between each measurement. The loudest leak noise will then indicate the location of the leak bearing in mind the ground conditions already mentioned. These basic principles can be used in a number of operational modes.

7.2 SURVEY BY LISTENING AT FITTINGS – ELECTRONIC LISTENING “STICK” ACCESSORY

All listening devices give better response when in direct contact with the pipe, particularly on metal pipelines.

In this mode the unit is used for locating leaks by fixing it onto a contact point or fitting, such as a valve, meter, hydrant or stop tap. A hand-probe/extension rod can be used to listen at these points and these provide good sound pick-up particularly if the pipe is metallic.

This procedure was once commonly referred to as “bashing” when used with mechanical listening rods and is used to narrow down the location of the leak, a procedure known as localisation since the leak will be “localised” to some point between the fittings. It will then be located to an approximate position and then “pinpointed” for the exact position prior to excavation.

It is important to note that when listening on pipe-fittings the location of the point of maximum noise will probably not indicate the leak position, only the fitting closest to the leak (Figure 7.3).

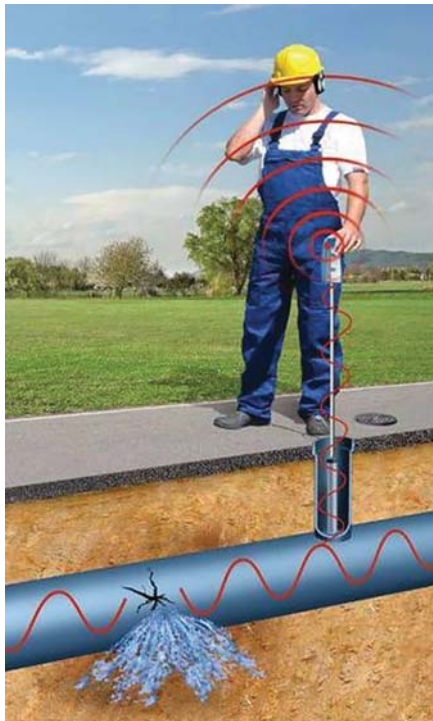

Figure 7.3 Leak position from sounding fittings. (Source: SEBA KMT)

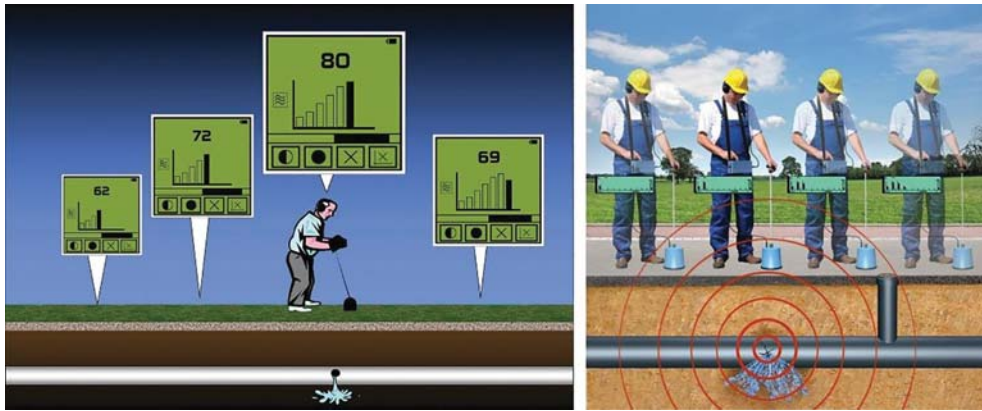

Figure 7.4 Surface sounding leak position. (Source: Halma Water Management and SEBA KMT)

7.3 SURVEY/PINPOINTING BY SURFACE SOUNDING “ELEPHANTS FOOT” – HARD GROUND

The ground microphone is used on the surface in the following circumstances: to pinpoint the leaks position after the “Localization” and “Locate” survey by listening at fittings; when no accessible contact points are available; when the pipe is of non-metallic material and no leak noise is being transmitted to available fittings.

The ground microphone is moved along the surface in regular positions following the path of the pipeline below ground with the operator noting the changes in sound amplification until the area of maximum noise level is identified (Figure 7.4).

To locate the position of an underground leak an acoustically shielded ground microphone foot (commonly known as an “elephant’s foot”) can be placed on the ground above the line of the suspect pipe and the readings observed. This is particularly useful on hard ground conditions and provides isolation from airborne noise interference which allows it to be used in noisy and windy conditions. On soft ground it is usual for a spike or tripod sensor to be used. A hand probe with a magnetic contact can also be used to provide excellent acoustic coupling to fittings, helping to ensure clearer, louder leak noise.

It is important to note that the noise level will also appear stronger where there is less thickness of ground or other material for it to pass through. The leak noise will always follow the path of least (acoustic) resistance.

7.4 OPERATIONAL EFFICIENCY – SURVEY VS. CONFIRMATION

Whilst it is recognised that the electronic ground microphone can be used for a complete leakage survey and pinpointing operation, using ground microphones in a survey operation is very labour intensive and involves operators covering (walking) large distances. Other modern technology is now available to survey large areas more quickly and efficiently.

Specifically, these methods include: (a) measuring flow into a self-contained District Metered Area and deducting known domestic and commercial usage in order to calculate the amount of real losses (leaks); (b) narrowing down the area by means of isolating parts of the distribution system (a procedure known as Step

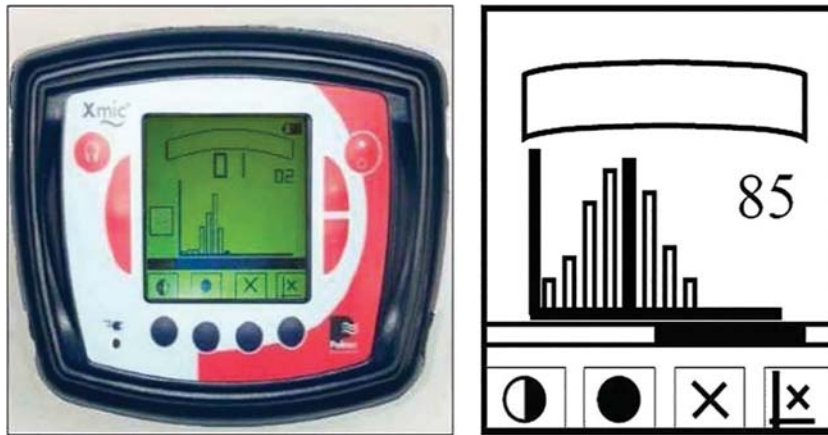

Figure 7.5 Images from electronic ground microphone. (Source: Halma Water Management)

Testing); and (c) deploying acoustic noise loggers along the pipeline within a District Metered Area to identify whether a leak may be present.

The above survey procedures are far more effective than using ground microphones to identify potential leak locations.

The modern Ground Microphone is therefore primarily used today as a confirmation of correlation results before excavation. This avoids errors due to unknown pipe characteristics, or operator error leading to dry holes or unnecessarily large excavations, and should be viewed as an essential final confirmation.

The illustrations (Figure 7.5) show how the electronic ground microphone is used effectively as a pinpointing tool prior to excavation, with the histogram of sample noises providing a clear visual depiction of the precise leak location.

In certain situations (nonmetallic pipes, poor pressure, holes in pipelines) leak noise may not travel over any distance along the pipelines and therefore pipe contact techniques may not be effective. In these circumstances the noise may still be sufficient at the surface above the leak to be identified by a Ground Microphone survey, and this may be the only practically effective acoustic technique.

7.5 ADVANCED FEATURES

7.5.1 Filters

Filters are required to selectively target and amplify leak noise and to suppress unwanted background noise and interference.

Metal pipes generally produce higher frequency leak noise as do small fractures, high pressures and hard compacted ground. Modern filtering allows the operator to set the instrument to focus on the leak noise and amplify it out of the background interference. Filter selection can be a great help, but it must be noted that unwanted noise may have a similar frequency to that of the leak, and not all ambient noise can be isolated out. For example, traffic and machinery noises often occur in the same frequency bands as leak noise and can travel for considerable distances through both air and ground material.

For this reason it is sometimes advisable to use acoustic leak detection techniques at night when interfering noises are less.

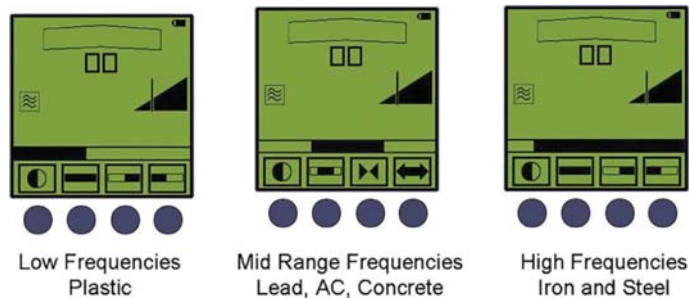

Figure 7.6 Filter settings for pipe materials. (Source: Halma Water Management)

The diagram below shows examples of approximate filter settings for sample pipe materials but please note that these are only given as a guide. The frequencies received will also depend on the ground conditions and type of leak and the filters may require further adjustment to remove unwanted background noise (Figure 7.6).

7.5.2 Memory comparison

Unlike its mechanical predecessor, the electronic amplified listening device enables automatic comparison of small noise differences to support the human ear.

Some advanced devices feature a minimum noise level memory to aid the operator to establish exactly the highest point of leak noise. This can greatly assist the operator to pinpoint the exact leak position, with comparison not possible by the human ear.

As the operator steps along the line of the suspect pipe listening to the sound levels, the device automatically records the base level of noise by checking and memorising the lowest noise level. This is the constant background (leak) noise. As the sensor is moved, a series of readings are taken. These are displayed digitally and graphically to show the difference between each reading clearly, for simple and precise pinpointing. The illustrations below (Figure 7.7) show that the memory comparison function clearly identifies that the leak is located at the highest point of the histogram.

In this example, eight consecutive readings have been taken by stepping the ground microphone along the length of the pipe and recording the leak noise at each position. This data is recorded and displayed as a

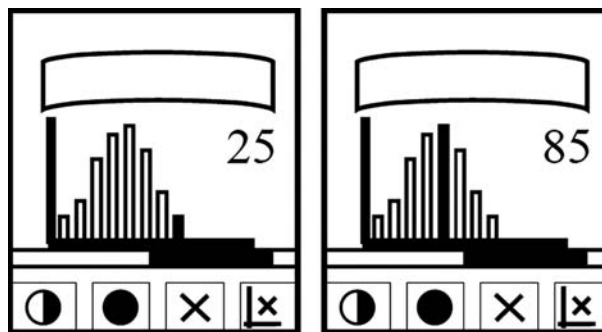

Figure 7.7 Ground microphone display. (Source: Halma Water Management)

vertical bar on a histogram. Each time a sample is taken, a relative number appears on the right of the screen. Each sample can be subsequently selected to check the relative number. This indicates the greatest leak noise acquired and the probable position of the leak.

7.6 AMPLIFICATION

Using the latest acoustic technology, modern electronic listening devices amplify signals which otherwise could not be heard by human ear, making them far more effective than mechanical listening sticks. The output of the amplifier is typically fed to high quality headphones to enable the operator to better detect subtle variations in frequency or pitch that enable the leak location to be positioned accurately.

The most effective portable amplifier modules have an integrated LCD display that enables noise levels and dynamic sensitivity (signal strength) received by the microphone to be displayed graphically as well as audibly.

7.7 REMOTE COMMUNICATION

The latest systems are available with a support app which uses smartphone technology to transmit results, and GPS stamped site reports to top end viewing software, or simply via e-mail to the supervising office. This prevents paper reports and the need to return to the office. Further developments include equipment that can also record the leak sound on site, and this also is transmitted through the app, for reporting, remote analysis or training purposes (Figure 7.8).

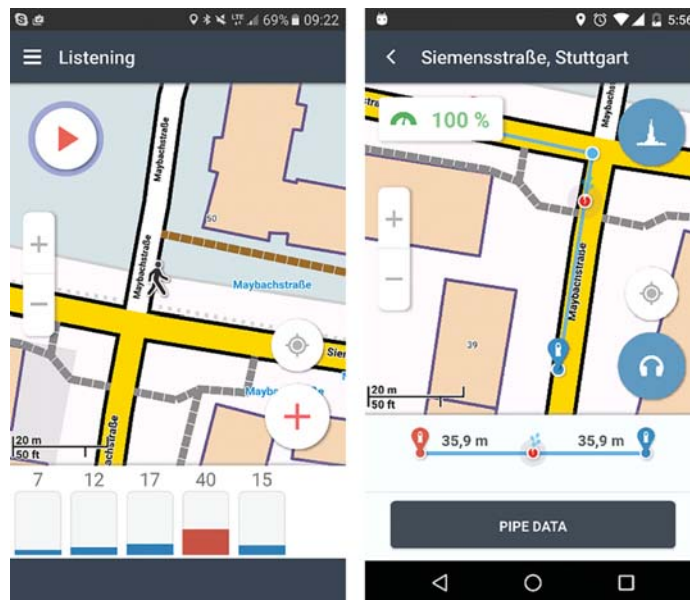

Figure 7.8 App interface for leak soundings and correlations including geospacial coordinates and mapping. (Source: Gutermann)

7.8 ADVANTAGES AND DISADVANTAGES

The operational advantages and disadvantages can be summarised as follows:

Advantages

- Low cost
- Easy to use
- Effective in some circumstances where techniques reliant on noise transmission through the pipe are not effective
- Provides effective leak confirmation following correlation.

Disadvantages

- Very labour intensive
- Inefficient when used as a surveying tool
- Difficult to operate effectively in high-noise conditions and busy urban environments which may require working at night
- Performance subject to soil conditions.

7.9 CONCLUSIONS

The electronic amplified listening device is an essential tool in the leak detection armoury. The most modern devices include advanced features to help the operator to survey, pinpoint and confirm leakage positions.

Whilst electronic devices with ground microphones are still used routinely in many parts of the world to survey areas of suspected leakage, its usage has evolved with the introduction of new areas of technology. Today, equipment exists that enables the leak detection operator to survey large areas much faster and utilizing significantly less manpower than that required by ground microphones alone.

However, the modern ground microphone is invaluable in general leakage work and particularly useful when used as a final confirmation of the leak position detected by a correlator prior to excavation, thereby greatly reducing the number of dry holes or unnecessarily large excavations (Figure 7.9).



Figure 7.9 Electronic amplified listening devices. (Source: Primayer)

Chapter 8

Method H: Acoustic correlation using accelerometers on large diameter pipe or non-metallic pipes

8.1 THEORY OF OPERATION

For large diameter or non-metallic pipes, the leak sound is attenuated more rapidly and particularly at higher frequencies. This principle is as described in Chapter 3.4, *Acoustic Principles – Attenuation*. Higher frequencies are always attenuated more strongly with distance than lower frequencies and this is much worse with softer pipe materials and larger diameter pipes.

As a result, conventional leak noise correlators have not been so effective when working on pipes of larger diameter, typically above 400 mm diameter, and on plastic pipes. They will locate some leaks, but the percentage success rate is greatly reduced.

Correlation devices optimised for large diameter or plastic pipes differ in that the sensors are more sensitive, the processing power of the correlator is much greater (Figure 8.1), they can often continue to correlate for a longer period, and they are optimised to detect very low frequency sounds (Figure 8.2).

It should be noted that for best performance on large diameter and non-metallic pipes hydrophone sensors are strongly recommended (see Chapter 9).

8.2 THE TECHNOLOGY

The principle of operation of correlation technologies is described in Chapter 4.3. Additionally, correlation devices for large diameter pipes and plastic pipes correlators can include advanced functionality such as:

- (a) Auto filter – automatically selects the most relevant frequencies to generate an optimized correlation peak, even in situations with very weak signals.
- (b) Automatic multi-frequency band correlation – allowing the user to easily detect multiple leaks on the same pipe section.
- (c) Narrow band filtering – automatically filters in narrow filter ranges



Figure 8.1 Trunk main correlator components and software. (Source: Gutermann)

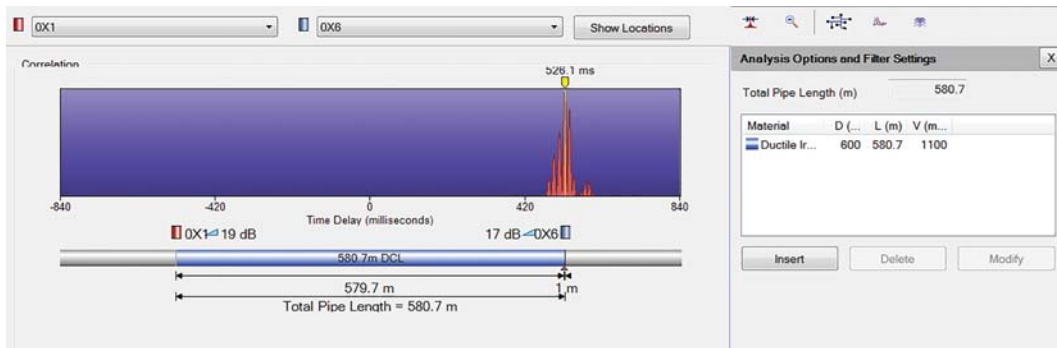

Figure 8.2 Leak location on 600 mm concrete lined ductile iron pipe over 580 metres. (Source: Primayer)

- (d) Notch filter – function removes fixed frequency interference, such as 50/60Hz electrical mains noise, from the sound spectrum, including higher harmonics.
- (e) Filtered listening – allows the operator to listen to the leak sound with selected filters applied. This is ideal for suppressing ambient noise like road traffic or electrical interferences.

On large diameter mains the correlation devices often have to operate over longer distances without access to pipe fittings. There are two solutions to this problem: (a) use transmitters that are considerably more powerful as well as the option to use antenna stands. This enables the user to correlate leaks over distances of 1 km or more; or (b) use correlating noise loggers.

Chapter 9

Method I: Acoustic correlation using hydrophones on large diameter pipes and on non-metallic pipes

The water-borne wave is detected directly by hydrophones placed into the water at convenient fittings such as fire hydrants. Trunk mains are also more difficult to monitor permanently because of their large diameters, the longer distances between access points, and the multitude of acoustic interference (low-frequency

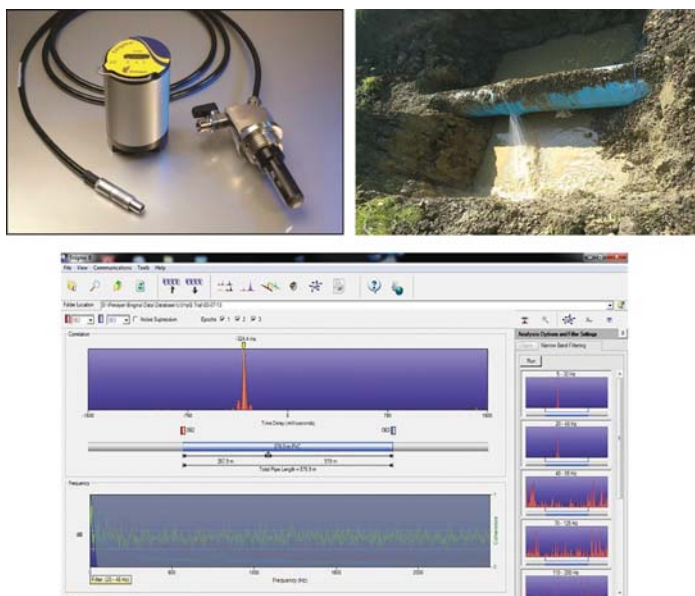

Figure 9.1 Correlation result with hydrophones on a 500 mm PVC pipe over a distance of 876 m, filter range 20–48 Hz. (Source: Primayer)

rumbling). In order to be able to successfully correlate in this situation, the functions listed in [Section 9.1](#) are utilised together with optimised low-frequency signal processing. The distance between two sensors can range from 300 metres up to typically 2000 metres.

9.1 PERMANENT CORRELATION MONITORING USING HYDROPHONE SENSORS

The system typically consists of the following components per measurement point, whereby two measurement points will be typically approximately 800 metres apart:

- high-sensitivity hydrophone sensor that listens directly inside the water column and transmits sound data via cellular communications to a data gateway
- data gateway to relay the sound recording to a central server or cloud solution
- automatic bleeding valve option to evacuate air bubbles trapped inside the pipe or hydrants just before the measurement
- power sources for the sensor and the gateway (either mains power, independent battery packs or solar panels for self-sufficiency). Smaller, internal battery powered models available ([Figure 9.3](#)).

Advantages

- Low labour intensity compared to frequent manual leak surveys
- Low running cost
- High pinpointing accuracy
- No need to close off valves or empty pipes
- Remote leak detection and network management
- Near-real-time (daily) leak alarm.

Disadvantages

- Relatively high initial system purchase cost
- Secondary on-field confirmation and localisation
- Some systems require need for permanently installed equipment above ground. (Below ground cellular communications systems are available.)
- Higher power requirements than other noise monitoring systems.



Figure 9.2 Solar-powered 3G data gateway on a nearby pole (right) and hydrophone sensor with external antenna and battery pack, plus automatic bleeding valve (left). (Source: Gutermann)

Recently, lower cost alternatives have become available for trunk main monitoring without the need for street furniture or permanent power supplies. This is a remote correlating noise logger which does not use GPS signals for time synchronisation and can therefore dispense with above-ground aerials. Instead it uses a combination of radio and cellular communications to provide accurate time synchronisation using only underground antennae. This allows daily monitoring of hydrophone data with the same pinpoint accuracy, though shorter duration audio recordings are made so external power supply is not required. The lower system and installation costs facilitate deployment of the system across larger areas (Figure 9.3).



Figure 9.3 Remote correlating loggers with hydrophone sensors showing leak location (the red dot) over a distance of 4618 m. (Source: Anglian Water/Primayer)

Chapter 10

Other techniques

Several other techniques have been developed as alternatives to the acoustic methods described above.

10.1 THERMAL IMAGING

Thermal infrared imagers are detector and lens combinations that give a visual representation of infrared energy emitted by all objects. In other words, thermal imagers let you “see” heat. Depending on the sophistication of your system, thermography is capable of providing very detailed images of situations invisible to the naked eye.

Thermal infrared pipeline surveys not only provide data on possible leakage points but also on the status of the wayleave (right-of-way), showing up any ground disturbance or building works over the pipeline. The surveys generally fall into two categories.

10.1.1 Low level surveys

These are surveys of the known course of a pipeline over open country. By carrying out a low level survey, extremely high resolution images may be produced which are invaluable to leakage engineers for defect identification and prioritization.

10.1.2 Higher level surveys

These are surveys of rural countryside where pipes lie but whose exact position is not known. These are usually flown at about 600 m (2000 feet), which gives a good balance between resolution and flying time (and therefore cost). The pipe or pipe bed is usually visible around 60% of the time depending on ground composition and cover.

Although infrared equipment is a valuable diagnostic tool, it merely provides a “map” of radiant energy. It cannot for example give a definitive answer to why a particular area is at a certain temperature or radiating at a certain emissivity. Consequently skilled interpretation can be a valuable source of advice in this

area. High resolution thermal imaging has proven to be a versatile technique for identifying pipeline (or reservoir) anomalies in rural areas in addition to identifying environmental effects such as discharge into watercourses.

The pipeline is flown over in a series of tracks, the number of which depend on the pipeline route. Each of these is related by an on-screen time stamp to the real time video data. This map is then marked with any thermal anomalies noted and used as the basis for discussions with pipeline management staff that are familiar with possible valid causes for many of the anomalies (for example, pipe infrastructure, fittings, valves and so on). This is often provided in parallel with a tabulated list of anomalies, their track number, time/date stamp, classification of priority (high, medium, low) and appropriate comment. The technique does require considerable man hours in analyzing and tabulating the data.

10.2 PIPELINE INSPECTION WITH THERMAL DIAGNOSTICS

The idea of finding leaks over a pipeline has been investigated now for many years, however with the new products launched and open to use by the general public the use of drones has dramatically increased to become a standard approach in photography, filming and now inspection of underground assets.

In practice, a drone is flown over the route of the pipeline and using a drone-mounted thermal imaging camera ground temperature variations are recorded which can indicate if a leak is present or not. In hot regions where the ground is warm, if a leak is present the surrounding ground is less hot due to the cooling effect of the water escaping the pipe. Conversely, in regions of very cold ground temperatures the leaking water warms up the ground. It is important to note the time of day that these surveys are completed in order to relate to the ground temperature.

10.3 INSPECTION OF PIPELINES USING INFRA-RED OR THERMAL IMAGING CAMERAS

Pipelines should be regularly and carefully checked for leaks particularly those that are in remote and obscured locations which make surveying difficult. In most cases these pipeline systems are often located underground or run for a long distance in areas where access roads are restricted and, moreover, the actual location of the pipeline is difficult to identify. Due to these reasons it is not possible to walk

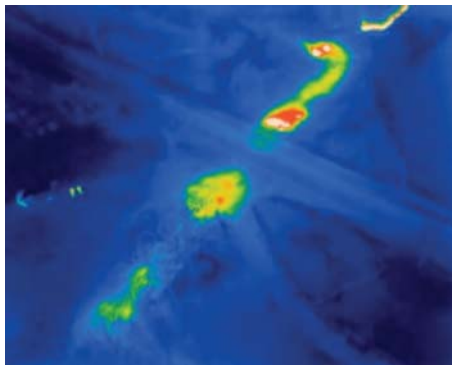

Figure 10.1 Water pipeline inspection using thermal imaging. (Source: Workswell Infra Red cameras and systems)

along these pipelines nor to be able to locate the valves or fittings to enable an acoustic survey to be undertaken.

To solve this issue the use of drones was identified (in the past a helicopter or airplane was used but at a significant cost). This simple, yet effective, approach can provide valuable information in leak identification by programming the drone to fly over the pipeline route taking live thermal images of the ground beneath along the pipeline (Figure 10.1).

The operator controlling the drone from a safe place has immediate knowledge of the found condition along the route of the pipeline and whether a leak may be present or not or indeed if there is a risk of damage to the pipe from other ground conditions.

Two cameras are located on a drone, one to take a general video and photographic images of the pipeline and the other for thermal imaging. The software that is controlled by the operator at the base station can easily switch between the cameras as necessary. The ability of the drone to stop and hover over a suspect location, zooming in where necessary while also surveying the surrounding region, has been a great advantage in the detailed investigation of leaks.

10.4 DRONES FOR LEAK DETECTION ACTIVITIES

Drones mounted with infrared or thermal cameras are used by water companies around the world to locate leaks and to reduce losses (Figure 10.3).

Many water companies have trained staff in the use of drones enabling the water company to very quickly find leaks in difficult locations not visible to the naked eye. The leak survey is normally carried out in the very early hours of the morning when the ground temperature is at its lowest, thus making it easier to identify underground leaks. The drone operators are licensed by the Civil Aviation Authority (Figure 10.2).

Normally the temperature of the water escaping from a leak is at a higher temperature than the temperature of the surrounding soil, which means that it will show up as a warm-coloured patch on the thermal imaging camera.



Figure 10.2 Use of a drone for leak location. (Source: Bath Echo)



Figure 10.3 A drone equipped with cameras for leak surveys. (Source: Bath Echo)

10.5 DOGS USED FOR LEAK LOCATION

10.5.1 A dog's nose

A dog's nose is composed of a nasal passage like a human's nose in which turbinates are located. Turbinates are the spongy tissues along the long shelves of bone in the breathing passage of the nose. It is these parts of the nose that are used to distinguish between smells. The internal construction of a dog's nose is such that it has ruffles or skin folds which means that there is an increased surface area so the number of turbinates is greatly increased. It should be noted that a human has 5 million turbinates and a dog over 300 million.

The long thin nose shape of a dog means that the complex network of its turbinates is such that can locate scents from the products that the dog has been trained for to identify. It is for this reason that not all dogs can be used for sniffing out drugs, money, people or in our case chemicals used in clean purified water.

Scientists during research have suggested that a scent sniffed by a dog passes through the turbinates and is then received at the olfactory bulb, which is a bulb of neural tissue within the dog's brain. A dog's olfactory bulb is many times larger than that of a human, about 44 times more. This gives a dog over 250 million more receptive smelling points than a human, hence the reason why dogs can distinguish so many more different scents than a human.

10.5.2 How does a dog complete leak detection?

Just as the human nose works when smelling goods, such as fresh cooked pizza or newly baked bread, and these smells are registered as a smell to remember, when a dog smells the same goods they can break down the smells to certain components of the product such as salt, pepper, yeast and so on.

If we apply this concept to the dog conducting leakage detection, then the dog is trained in the ability to smell a chemical that is added to the water such as chlorine. The dog is trained to find very small concentrations of the chemical therefore in some instances the dog can smell the chemical through many ground materials. The dog's ability to distinguish between smells and only react to the ones they are trained to locate, means that they will not be fooled by other sources of water, i.e. spring water. Properly trained pipeline leak detection dogs have been tested and proven to be accurate in the range 96%–99%.

In field trials, a dog that has been trained in locating a water leak has managed to find the leak being emitted from a small hole under pressure at a depth of up to 4 m. It has to be noted that ground materials and backfill have an effect and the chlorine gas element has to be able to permeate to the surface although by a minor amount.

10.5.3 Dogs vs conventional methods

There are many types of methods of locating water leaks and all with a varied success in the field when being used. The idea of using dogs is a new concept recently started in around 2015 and this may be the process in the future. However, at this stage it is being tested to various degrees of success and should be considered as another idea to add to the process to find water leaks.

10.6 GROUND PENETRATING RADAR

GPR (ground penetrating radar) is so named because the radar is able to produce an image of what is below the ground by reflecting radar frequency waves emitted by the transmitter from any interface within the ground, this being earth/water, earth/rock, rock/air and so on back to the receiving antenna. Usually this antenna is part of the same unit as the transmitter which is drawn over the ground at a slow speed producing data which is processed and converted into vertical cross-sectional slices of the ground.

This image is shown on a screen for the engineer to interpret the results and decide whether a leak is present. This requires an experienced engineer to decipher. The depth of vision can be as much as 3–5 m but this is in perfect situations which are rarely seen (Figure 10.4).

There were several European Union co-funded research projects on technology – with varying results and successes. Two such projects are “Waterpipe” and “Leaking”. The projects have similar objectives – to provide a non-intrusive leak location technology:

“Waterpipe” is a system where the leak is located by Ground Penetrating Imaging Radar – GPIR. The objectives of the project were to investigate and develop a high-resolution imaging ground penetrating radar for the detection of pipes, leaks and damages to underground infrastructure – and to provide imaging of the damaged region. A further enhancement was to produce an integrated system that will contain both the GPIR equipment and a Decision-Support-System (DSS) for the rehabilitation management of the underground water pipelines. This would use input from the inspections to assess, probabilistically, the time-dependent leakage and structural reliability of the pipelines and a risk-based

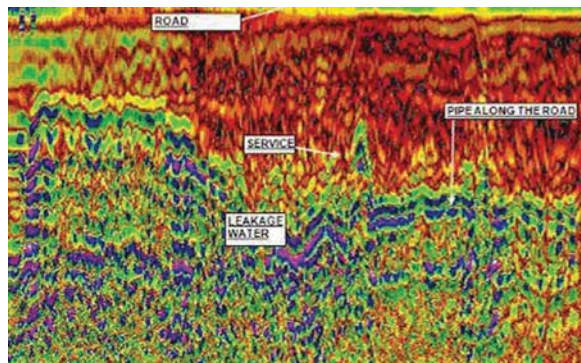

Figure 10.4 Data from ground penetrating radar. (Source: R Brier)

methodology for rehabilitation decisions that considers the overall risk, financial, social and environmental criteria.

“Leaking” had objectives to investigate and develop an innovative leak inspection equipment for water pipelines based on microwave technology (a Continuous Wave Doppler radar, a Frequency Modulated Continuous Wave radar and a radiometer), and a decision support system, that stores available data on the pipe network, and receives input from leak inspections. It should be able to perform condition assessment to determine residual lifetime of the pipeline in question.

Chapter 11

Optimization tools for leak location – Hydraulic model

The water industry has accepted a hydraulic model as a routine computer simulation tool to analyze the hydraulic characteristics of the system elements (pipes, pumps, valves and storage facilities). Optimization technology has been developed to enable water companies to make use of the well established computer model for low cost localization of leaks. Although it is impossible to exactly locate the water losses or leakages in a distribution system by just using an optimization-simulation approach, case studies have shown that the method is effective in helping engineers to narrow down the possible water loss (including leakages, un-metered and illegal consumptions, etc) and thus enable more efficient leakage reduction programs.

11.1 OPTIMIZATION PRINCIPLE

The method requires a hydraulic model together with pressure and flow logging data from the network, which are used by an optimisation technique to identify the likely leakage hotspots that are emulated as emitters where leaks occur and depend on the local pressure. Genetic algorithm (GA) techniques have been used to search for the leakage hotspots such that the difference between the simulated and field observed pressures/flows is minimized. Engineers need to repetitively run the optimisation tool with the MNF-hour data for the same network model. Multiple runs provide an indication of most likely leakage hotspots in the network area. The essential steps for applying the optimization modelling method are as given below.

11.2 SYSTEM EVALUATION

Prior to embarking on leakage-detection optimization modelling, it is essential to evaluate the system behaviour by using the hydraulic model. [Figure 11.1\(a\)](#) illustrates system layout and connectivity. The DMA's supply boundary is simulated by using a reservoir with variable hydraulic

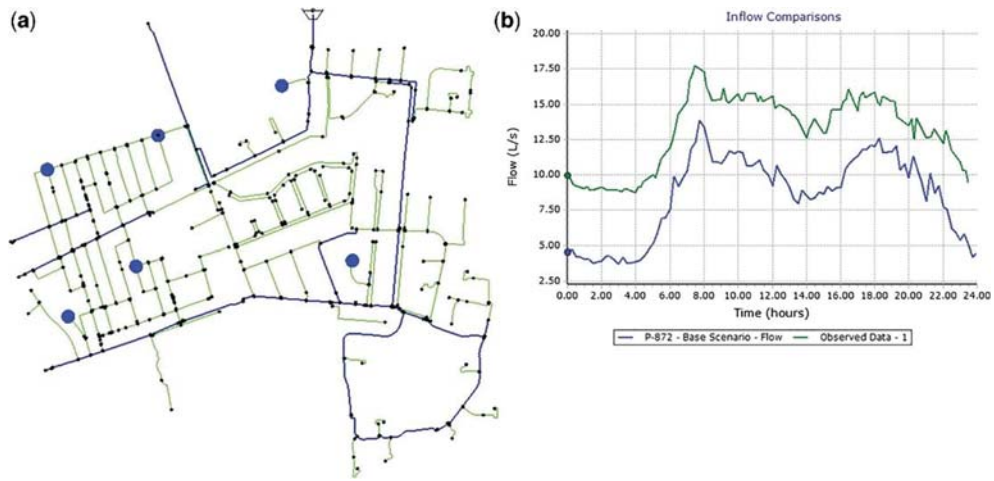

Figure 11.1 System evaluations prior to leakage detection optimization: (a) system layout and connectivity; (b) comparison between observed and simulated inflows. (Source: Bentley WaterGEMS, Darwin Calibrator Module, Bentley Systems Incorporated, Exton, PA, USA)

heads. The inflow into the DMA is recorded as time series over 24 hours and six pressure loggers are used for collecting pressures from the field. An extended hydraulic simulation is performed to evaluate the existing behaviour of the system. Figure 11.1(b) shows the comparison between the observed inflows and the simulated flows. The big flow difference at each time step represents the water loss within the DMA.

11.2.1 Field data process

A large set of data is collected from the field, including the pressures and the flows. The data is prepared and classified into different datasets. Each of them represents a snapshot of the system observation at the same time.

11.2.2 Optimization analysis

Leakage detection optimization study proceeds with setting up the optimization runs and then executing the runs. The software tools are flexible and powerful enough to permit engineers to use system-specific knowledge to make different target groups for effective leakage modelling.

11.2.3 Post-optimization analysis

It is important to process the identified leakage solutions, namely the identified emitter locations and the emitter coefficients. The post-optimization process includes creating a leakage node map as shown in Figure 11.2, in which each identified leakage node is represented by the colour-coded node for intuitive presentation of the most likely leak areas. The colour map can be used as a good guide for a field detection crew. The optimized leakage solution can be further evaluated by comparing the observed and simulated inflows over 24 hours. Figure 11.3 illustrates that the identified leakage nodes significantly improve the flow comparison.

There are a number of alternative techniques in use. All use one or more time steps in the network model. The differences in the techniques relate to the details of the optimization methods, pressure-demand

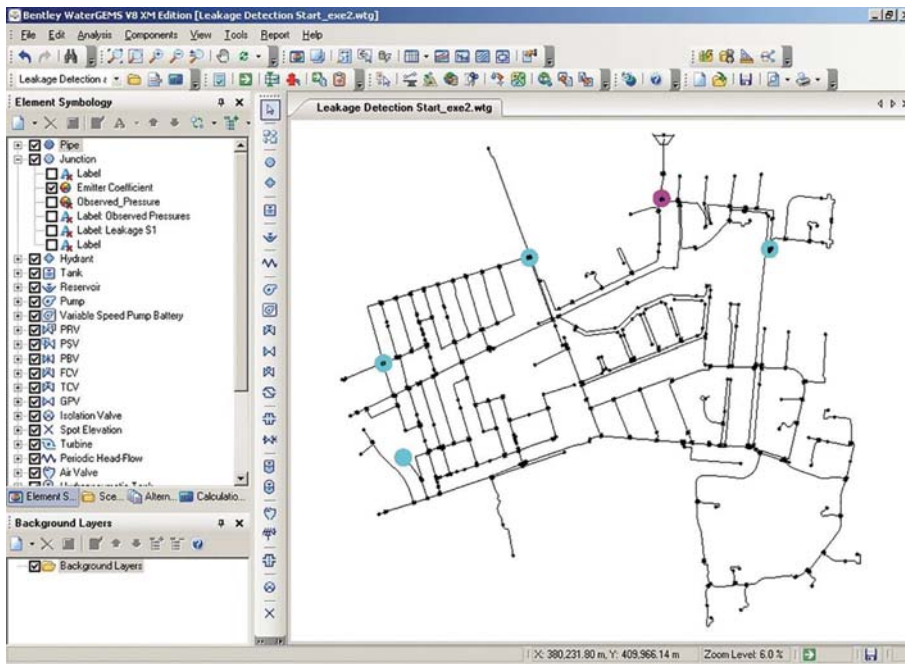

Figure 11.2 Created leakage map of identified leakage hotspots. (Source: Bentley WaterGEMS, Darwin Calibrator Module, Bentley Systems Incorporated, Exton, PA, USA)

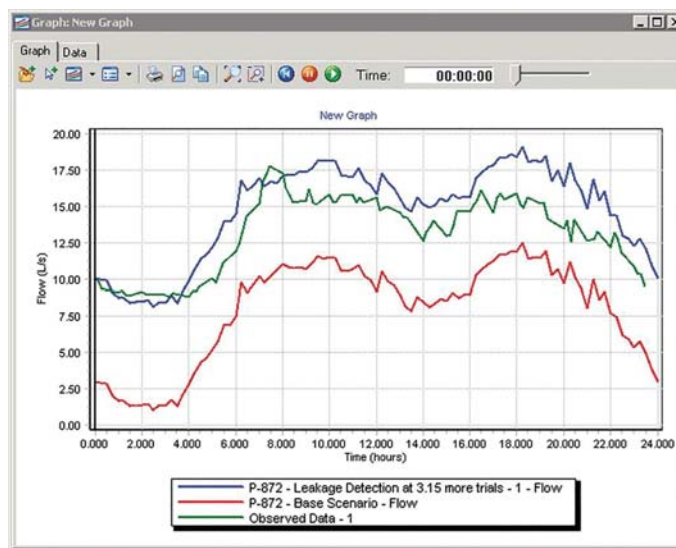

Figure 11.3 Comparison of the field-recorded flows with the extended period simulation. (Source: Bentley WaterGEMS, Darwin Calibrator Module, Bentley Systems Incorporated, Exton, PA, USA)

relationships, choice of time steps, the amount of demand re-allocated and the rules used for the demand re-allocation.

The location of the re-allocated demand gives an indication of leak locations or additional hidden demand. The approach will not pinpoint the leak location but will localise it, to make detection by other methods more cost-effective.

Chapter 12

Step testing

Step testing is an effective, flow-based method of localising water loss within a zoned distribution system. It is particularly suited to identifying areas of high leakage and to use on plastic pipe materials, where leak noise is absorbed and conventional acoustic methods are less effective.

To perform a step test the inflow into a zone must be monitored. This can be achieved by deploying a data logger upon the inlet water meter to automatically transmit flow data to the operative in the network. Alternatively an additional operator can be left upon the inlet meter to manually record flow and network activity.

Once a method of monitoring has been established, then valves are closed to cut off sections of the zone known as “steps”. This demonstrates how much water is consumed in each step. Each step has an estimated customer consumption which is compared with the drop in flow at the inlet meter. If the difference between the actual drop in demand and estimated consumption is significant, this provides an indication to the operative that leakage is contained within that Step.

There are several different variations on the approach depending on the technology available, whether it is important to maintain supply or the configuration of the network.

12.1 PRINCIPLES OF STEP TESTING

The following outlines the principles of step testing.

- Each zone will require a plan that identifies which pipe lengths are to be used, valves to shut and in which order valves are to be shut. This should be used for all subsequent step tests, providing the zone does not change. By keeping the plan consistent the operators can provide further judgement based upon experience.
- When designing a step test plan it is important to have an optimum amount of “steps”. This will largely depend upon the size of the zone. Too few steps may not achieve the desired reduction in

leakage detection time and costs. Too many steps can be time consuming and the rate of leakage may be too insignificant for the flow meter to register.

- Another consideration when designing steps is to calculate an estimation of customer consumption so that the operative has an expectation of a typical flow rate into a step.
- Step tests should be carried out when demand is at its lowest. This tends to be at night between the hours of 01:00–04:00 am. This helps contribute to a more accurate step test as fluctuations in demand are minimised.
- Before a step test is implemented all valves required must be located on site. Once located then the integrity of the valve must be tested. This will include ensuring the valve is accessible and operable. A Zero Pressure Test (ZPT) can conclude if the valve can be closed completely without passing any water, this helps contribute to further reassurance of an accurate step test.
- There are two options in providing essential flow data to the operator closing valves in the network:
 - (1) Another operator upon the inlet meter with telephone/radio communication to the operator in the network operating valves;
 - (2) Radio/GPRS data logger to transmit flow data to a suitable receiving device for the operator in the network to see live flow data.
- There are three types of valves when operating a step test:
 - (1) Valves that are permanently shut to create a zone. These can sometimes be called boundary valves or zone valves.
 - (2) Valves that need to be shut before the start of the test in order to create steps that can be closed off during the test with a single valve, as sometimes it is not possible to shut off a section by using only one valve closure. These valves are only shut for the duration of the test and re-opened once the test is completed. They are sometimes known as circulating valves.
 - (3) The final type of valve is one that isolates a step from the zone. They are numbered according to the order that they need to be shut in during the test. Step 1 is typically the step that is the furthest away from the meter and the last step closure is the one nearest the meter (Figure 12.1).

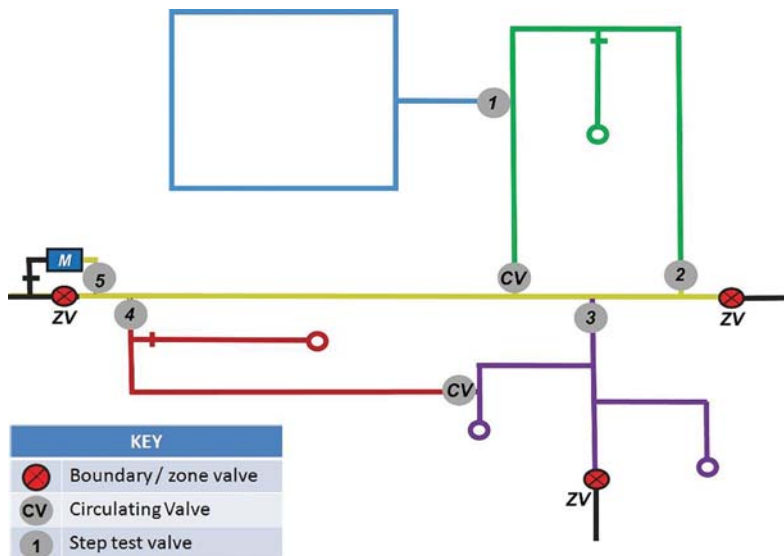

Figure 12.1 Showing a Step test plan with valves labeled accordingly. (Source: Primayer)

Table 12.1. Step test valving schedule (Source: Halma Water Management)

DMA Name	Test Area	DMA Number	555
Test Details:			
Valve Number	Operation	Time	Flow(l/s)
Circ 1	Shut	02:00	10
Circ 2	Shut	02:15	10
Test 1	Shut	02:20	8
Test 1	Open	02:25	10
Test 2	Shut	02:37	9
Test 3	Shut	02:51	5

- It is important to allow a settling time (approximately 15 minutes) between each step closure so that a stable and realistic flow rate can be obtained.
- It is good practice to record when all network events occurred, for example valve closures. So that thorough analysis, if required, can occur at a later date (Table 12.1).

In Figure 12.2 drops in flows are shown as the steps are being closed. The burst was located in the final step where the flow reduces considerably. The opening of the closed step valves after the test has been completed can be seen to the right hand side of the graph (Figure 12.3).

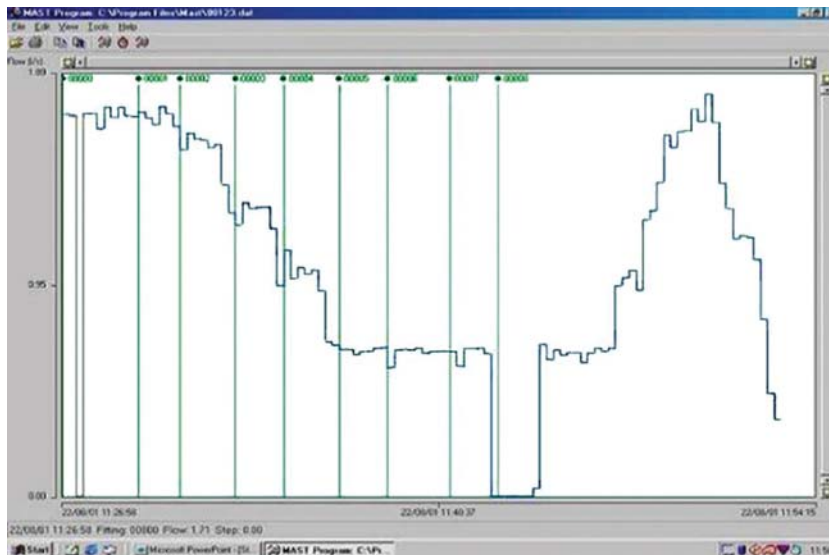
**Figure 12.2** Graph showing results of a step test. (Source: MAST PC Software V5.03, Halma Water Management, Cwmbran, Wales)

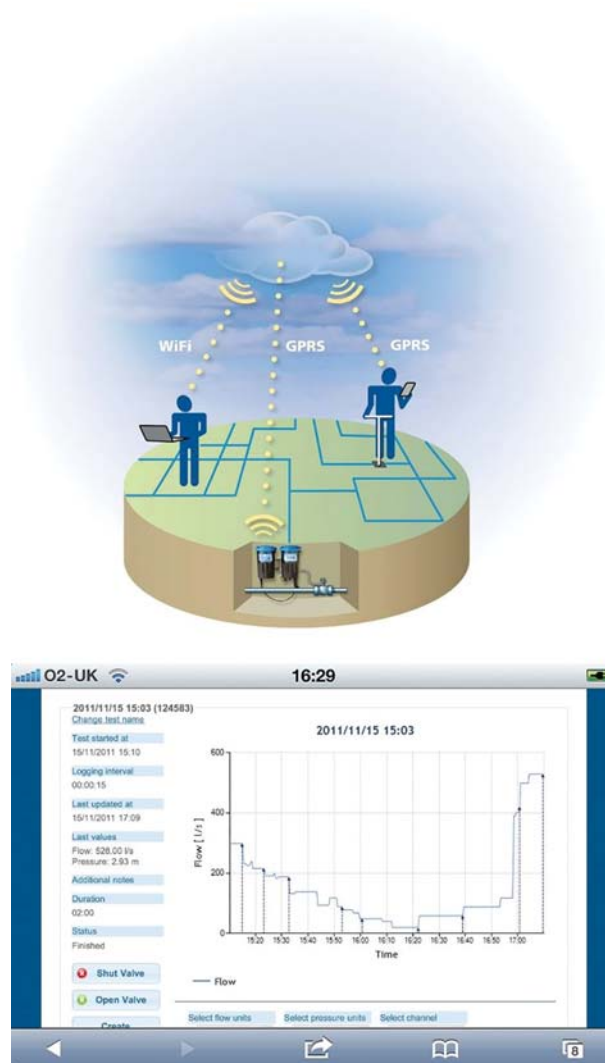

Figure 12.3 Advanced step testing (top) and data from advanced step test (bottom). (Source: Primayer)

12.2 ADVANCES IN STEP TESTING

Current technology and consumer pressures on levels of service have led to an alternative method of step testing that avoids using predetermined steps. By obtaining real time data operators can instantly view the flow changes in the network. This can reduce leakage detection time and costs further.

The approach of step testing using real time monitoring now provides the opportunity to carry out a halving and quartering technique where the zone in question is “sectioned off” for very short periods of time. This helps minimize the disruption to supply as length of mains are not left in the closed position for a period of time. This is essential in regards to water quality and as society is becoming more active over the night-time period.

A valve which will allow the zone to be cut in half is located and closed to see which half contains the leak; this subzone is then halved again and so on until the leak is located to a section of main. There are no criteria as to how this is completed but potentially a leak could be found by only closing a couple of valves. As with the traditional method of step testing, customer consumption must be estimated for each half, quarter and any subsequent division. The operator can then compare the actual flow rate with the expected flow rate, again any significant difference raises an indication for further leakage investigation.

Chapter 13

Software-based solutions

13.1 INTRODUCTION

With advances in digital technologies and data analytics, software-based solutions are being used by the water industry for leak detection, water loss reduction and water efficiency. These solutions need to be accompanied by changes in the mindset of the organization, with an acceptance that analytics can be used by utility management for decision-making and planning.

If we look at the last 10 years, the industry has gone through an evolution, building its trust in data and algorithms. The evolution of software solutions for leak detection can be divided into four main phases.

13.1.1 1st phase: Anomaly/Leak detection by analytics

Water utilities start to detect leaks using simple anomaly detection and statistical algorithms. Flow data was analysed in real-time using time series algorithms, leveraging on flow trends, and consumption patterns. Data from acoustic leak detection systems could also be added to the analysis. Separately, another strand of analytics led to the first leak *prediction* algorithms, based on statistical clustering of data on pipe composition, age, soil type, pressure history and so on.

13.1.2 2nd phase: Event detection by analytics

Leaks are not alone...with many anomalies in the water network, the solution evolved into event detection. Using data analytics and anomaly detection to detect multiple events or incidents in the network, the software expanded the range of anomalies which could be identified, e.g. leaks, bursts, pressure issues, asset problems, water quality to name but a few.

13.1.3 3rd phase: Event management

Once detections were made, it was necessary to bring to the users more information about each leak and other events, e.g. when it started, how big it is. With the growing need to extract more information,

manage each event and prioritize them, software solutions turned into ‘event management’, managing the life cycle of the event, from start to resolution.

13.1.4 4th phase: Central event management (CEM)

This is when Central Event Management (CEM) came about, evolving into a central layer for managing all network events and bridging the operational silos between various stakeholders by integrating all the IT modules in the event software.

In a similar way that Customer Relationship Management (CRM) systems provide a central platform for all customer-related information, software-based CEM provides a central hub for incident-related information, combining all the different data sources of events into one operational layer, shared by all who need to see it.

13.2 ABOUT CENTRAL EVENT MANAGEMENT

Central Event Management (CEM) is a holistic system for water infrastructure management, which uses data analytics and machine learning to combine data and information from several sources into a single function.

Network events and incidents are detected early using anomaly detection and predictive analytics. An “event” is any incident or anomaly which the CEM system detects and then captures, analyzes, and prioritizes a response (Figure 13.1). Such events can include leaks (hidden or open), bursts, faulty

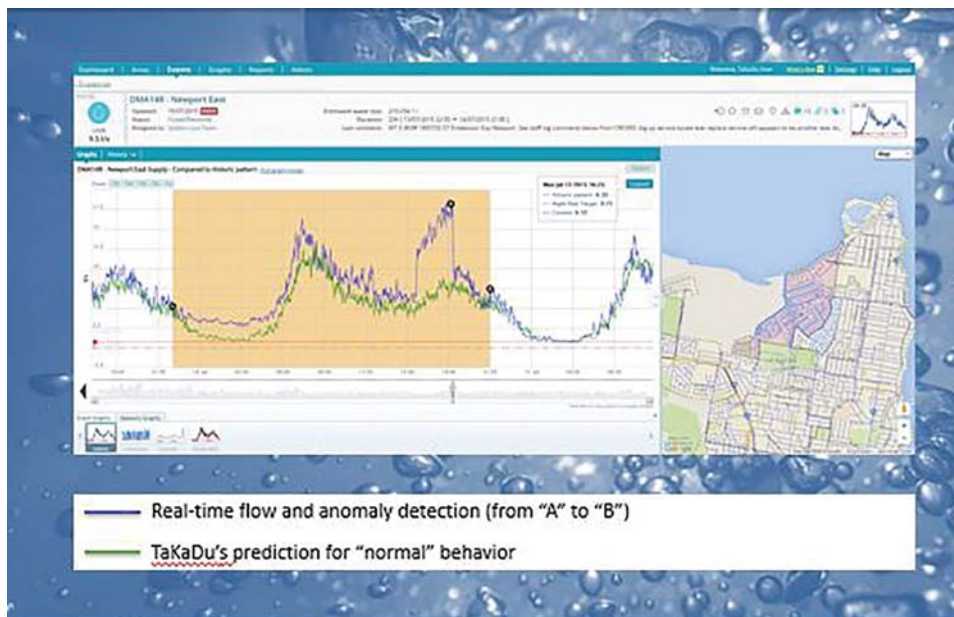

Figure 13.1 Typical leak event screen shot, showing predictive patterns; analysts can also see the zone where it is appearing. (Source: TakaDu)

assets, telemetry and data issues, operational failures and water quality changes. CEM supports the event lifecycle including:

- Detection
- Classification, characterization and measurement of the event (e.g. size and severity)
- Response initiation
- Response verification and implementation via workflow management
- Outputs to SCADA, work orders and asset management; alerts to external agencies
- Event prediction and maintenance planning.

CEM integrates with other enterprise IT systems in the utility to provide a single layer of information about events and incidents. These systems can include GIS (e.g. Esri ArcGIS® Online), Enterprise Asset Management (e.g. IBM® Maximo®), CRM (call centers), AMI data, and acoustic loggers (e.g. GUTERMANN, Aquarius Spectrum).

All events are managed in one interface. With information aggregated from different data sources, the utility can take the relevant action, for example sending out field teams to check assets, and verifying that repairs have been carried out successfully.

CEM systems may also share data with other agencies such as emergency services, energy and highway, enabling greater coordination after a major storm or flood, where bursts might cause widespread disruptions. Management dashboards and reports are also provided for leadership teams for ongoing asset management and regulatory compliance.

13.3 BRIDGING OPERATIONAL SILOS

In many cases, different departments operate as independent silos, maintaining their own data. This can become a problem when the utility tries to make system-wide improvements to respond to incidents and emergencies. The different silos contributions may be affected because they are not effectively

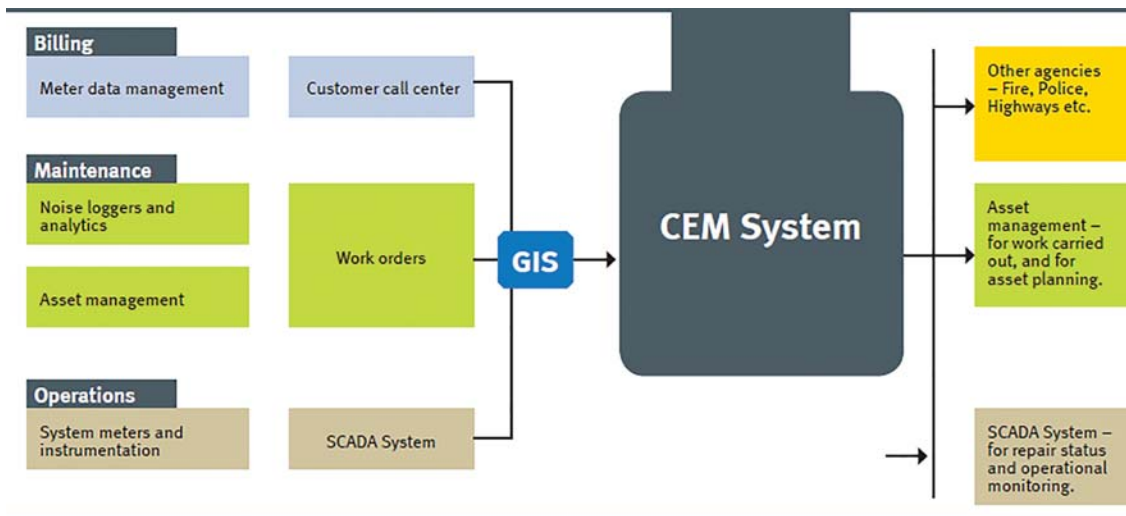

Figure 13.2 CEM integration with other enterprise IT systems. (Source: TakaDu)

coordinating with each other e.g. asset planning, operations, maintenance and customer service, all disconnected from one other. This can affect the quality of service and increase costs and delays unnecessarily.

The silos exist for good reason and are not going to go away. However, improved performance requires people and processes to be aligned across the silos in order to benefit from new technologies. More value is gained when data is combined from different sources, enabling action, insight and coordination that bridge operational siloes.

By integrating with other systems and technologies in the water ecosystem in a modular way, CEM helps to bridge these silos, providing users with an overall picture of operational activities. With all network systems data flowing into the same central hub, CEM facilitates interactions between different departments, such as asset planning, maintenance, customer service, back office and field operations. Events are managed faster and more effectively with clearer workflows and operating procedures (Figure 13.2).

13.4 CEM INTEGRATION EXAMPLE

CEM integration with acoustic loggers provides alerts and events from multiple, independent data sources enabling event validation (Figure 13.3).

13.4.1 A brief case study

A leading Australian water utility implemented a software-based CEM solution for improving network efficiency, reducing network costs and improving its customer service in around 90% of its water network. The management team formed working groups from different departments across the organization departments (including, billing, operations and contact centers), providing a focal point for collecting information and smarter decisions.



Figure 13.3 CEM platform integrated with GUTERMANN system. (Source: TakaDu)

As a result, the CEM system served as an efficient management and information system for gathering and disseminating data, improving processes and reducing operational costs. Millions of dollars were saved in hidden (underground) leaks and repair cycles were shortened by over 60%.

13.5 SUMMARY

Software-based CEM is increasingly being deployed by water utilities to improve water management. The solution is based on three core components: data analytics, providing insights based on advanced statistical methods; event management, managing the event life-cycle; and a SaaS (Software-as-a-Service) solution, analyzing multiple types of data in real-time.

Chapter 14

Satellite leak location

14.1 BACKGROUND

Radar (Radio Detection and Ranging) is an object-detection system that uses electromagnetic waves in the radio or microwave domain to determine the range, angle, or velocity of objects. Microwaves are a type of electromagnetic (EM) radiation with wavelengths in the spectrum between 0.001 and 1m, shorter than normal radio waves but longer than infrared radiation (Figure 14.1). Radar was developed secretly for military use by several nations in the period before and during World War II.

A radar system consists of a transmitter producing electromagnetic waves in the microwaves domain, a transmitting and receiving antenna (often the same), and a receiver and processor to determine properties of the object. Radio waves (pulsed or continuous) from the transmitter reflect off the object and return to the receiver, providing information about the object. Radar signals are reflected especially well by materials of considerable electrical conductivity, most notably by most metals, seawater and by wet ground. The weak absorption of radio waves by the medium through which it passes is what enables radar sets to detect objects

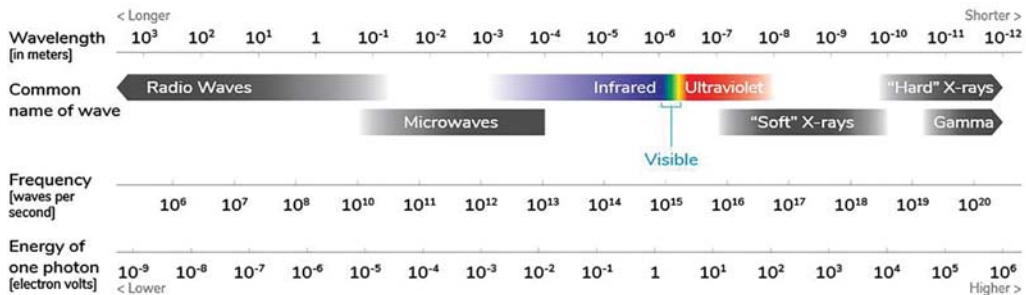

Figure 14.1 The electromagnetic spectrum. (Source: Utilis)

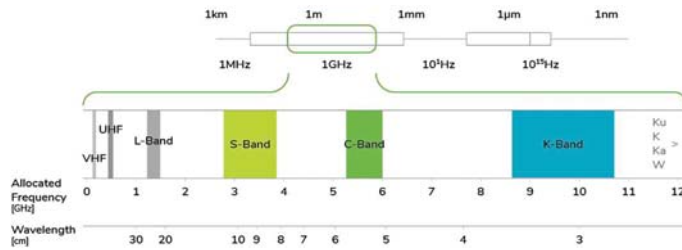

Figure 14.2 Radar frequency bands. (Source: Utilis)

at relatively long ranges, ranges at which other electromagnetic wavelengths, such as visible light, infrared light, and ultraviolet light, are too strongly attenuated.

The traditional radar frequency band names originated as code names during World War II and are still used throughout the world in military and aviation (Figure 14.2). Radar used to track ballistic missiles, or that have over-the-horizon, foliage penetration or ground-penetrating applications include HF (high frequency), UHF (ultra high frequency) and VHF (very high frequency) have bands with frequencies in the 3–1000 MHz range. Radar used in weather applications, air traffic control and missile guidance have frequencies in the range 1–12 GHz and include L (long), S (short), C (compromise) and X (secret in World War II) bands. Radar in the W band (75–100 GHz frequency range) are used in self-driving cars. These land-based applications typically use a pulsed technique whereby an area is illuminated in short bursts and echoes are received in the quiet period in between. Doppler characteristics can determine location, velocity and direction of targets. The performance of radar systems can be gauged by their range, accuracy, ability to filter noise and ability to recognize the intended target. These are greatly impacted by transmitter power and physical size of antenna.

Other systems similar to radar make use of other parts of the electromagnetic spectrum. One example is Lidar, which uses ultraviolet, visible, or near infrared light from lasers rather than radio waves.

Microwave imaging is a science that has evolved from older detecting/locating techniques, such as radar, in order to evaluate hidden or embedded objects in a structure (or media) using electromagnetic (EM) waves in microwave regime. Microwave imaging has been used in a variety of applications such as non-destructive testing and evaluation (NDT&E), medical imaging, concealed weapon detection at security checkpoints, structural health monitoring, and through-the-wall imaging.

14.2 REMOTE EARTH IMAGING

Seasat was the first earth orbiting satellite designed for earth sensing (of the oceans) using synthetic aperture radar (SAR). SAR is a form of radar that is used to create two- or 3-dimensional images of objects such as landscapes. SAR uses the motion of the radar antenna over a target region to provide finer spatial resolution than conventional radars. SAR is typically mounted on a moving platform such as an aircraft or spacecraft. The distance the SAR device travels over a target in the time taken for the radar pulses to return to the antenna creates a large “synthetic” antenna aperture (the “size” of the antenna). The larger the aperture the higher the image resolution will be, regardless of whether the aperture is physical (a large antenna) or ‘synthetic’ (a moving antenna). This allows SAR to create high-resolution images with comparatively small physical antennas.

To create a SAR image, successive pulses of radio waves are transmitted to “illuminate” a target scene and the echo of each pulse is received and recorded. As the SAR device on board the aircraft or spacecraft

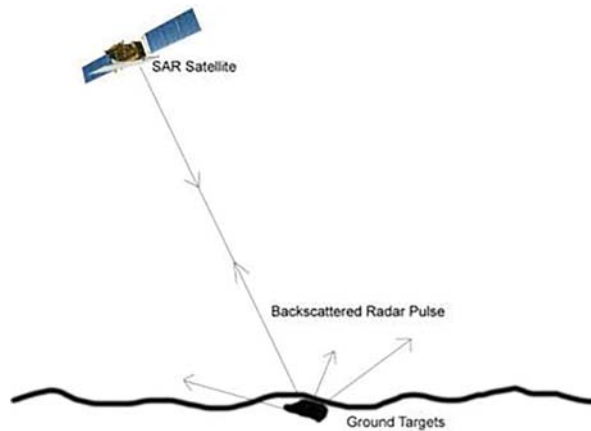

Figure 14.3 SAR schematic. (Source: Utilis)

moves, the antenna location relative to the target changes with time. Signal processing of the successive recorded radar echoes allows the combining of the recordings from these multiple antenna positions to produce a correlated image (Figure 14.3).

The merging of the characteristics of long band radar, including ground penetrating abilities, and, the capabilities of SAR to capture high resolution images from large distances with small physical antennas, has led to an innovation in the water space; namely, identifying leaks from remote platforms using radar from existing orbiting satellites. Time is purchased on a satellite to illuminate a certain area. The satellite is directed and focused at the target based on certain underlying algorithms, which is then analyzed, based on those proprietary algorithms, to determine dielectric constants which denote leaking water pipelines. A map of the likely locations of leaks is the deliverable.

The leak target map deliverable is the first step in managing leaks. Field crews will always be a necessary and critical component of the process by confirming leaks via inspections and making repairs. The map provides specific areas to focus field crew deployment to maximize efficiency. Efficiency can be defined as leaks discovered per kilometer of pipe inspected, or leaks found per crew day.

Radar SAR can be used for remote detection of underground water, for example, drinking water leakage from an urban water system (Figure 14.4). Water sources such as water pipes, lakes or swimming pools reflect electromagnetic (EM) waves, both below and above ground level. Water sources reflect microwaves in long band frequencies when illuminated from the satellite. Every water source has typical reflections and typical EM behavior, therefore the type of the water source may be identified using these typical reflections.

SAR sensors placed on an elevated platform such as a satellite or an aircraft send EM waves at a known frequency towards an area and read the EM waves reflected from that area. The sensor sends a scan that includes all the reflections detected from a particular area to further be processed by a system according to mathematical algorithms. SAR uses the motion of an antenna over a target region to provide finer spatial resolution than is possible with conventional beam-scanning radars. The scan includes all the EM reflections received from the area. These reflections include reflections from water sources and undesired reflections from other bodies in the area, such as buildings, vegetation and other topographical features of the area. In order to identify the water-related reflections, the undesired reflections (e.g., EM noise reflection) is filtered or removed from the scan. In order to reduce, remove or filter the EM noise, two or more scans are taken from the area at different polarizations. For example, two of them are a



Figure 14.4 Map of leak locations from a Radar SAR. (Source: Utilis)

horizontal-vertical (HV) scan and horizontal-horizontal (HH) scan are both taken of the target area of interest. The HH reflections are received from transmitting waves having a horizontal polarization that were received at horizontal modulation. The HV reflections are received from transmitting waves having a horizontal polarization that were received at vertical modulation.

Additional scans having additional polarizations may also be received from the single sensor all with the same resolution. Such additional scans allow for further reduction of the EM noise.

After the filtration of the EM noise some of the scanned reflections can be identified as water reflections. Since different water sources (e.g., drinking water, sewage, seas, lakes swimming pools, etc.) have different typical EM roughness (typical EM reflections), it is possible to distinguish one from the other. EM roughness from sewage pipes, seas, lakes and swimming pools are filtered or removed from the filtered noise scan thus leaving in the scan only the reflections received from pipeline water leakages.

Radio Frequency Interferences (RFI) are a technical challenge for SAR imagery in certain locations. RFI is a disturbance caused by local transmitters (i.e., cell or TV towers) of similar frequency band which causes an EM noise phenomenon in the imagery. Detecting and correcting the corrupted signal improves the project success.

Chapter 15

Geospatial AI for pipeline failure risk

Geospatial AI (artificial intelligence) leverages the power of machine learning and automated pattern recognition to deliver sophisticated geospatial data analytics for a host of industries, including the water, agriculture, infrastructure and forestry sectors.

For the water industry, Geospatial AI is a cutting-edge technology to identify the conditions under which network failures occur. It combines local environmental data such as soil, weather and topography, regular insights derived from Earth-observing satellites, with data on pipeline attributes, such as material, age, depth and diameter. Together, these data are integrated into a sophisticated risk model that considers both pipeline characteristics and relevant aspects of the environment in which the pipeline resides.

These data are then calibrated against historic failure event data in the model, which help train and validate machine-learning algorithms to produce a risk analysis. With all this information in hand, machine-learning techniques are applied to current data to recognise patterns and produce insights. The resulting analytics quantifies the likelihood of failure across a network.

Geospatial AI does not provide information on the precise location of water losses or leakages in a water network. Instead, it provides an innovative method for proactive pipeline risk management and strategic investment planning by offering crucial information on how to optimise the deployment of resources, repair and maintenance, and capital expenditure based on the likelihood of failure at the whole network level or DMA level. Furthermore, by regularly updating contemporary data, risk hotspots can be tracked temporally to allow rapid identification of high-risk sections.

The information Geospatial AI provides has significant real-world impact. Taking just two years of historic data to train Geospatial AI algorithms, areas of the network more likely to be at risk from failure can be prioritized for investigation to enable efficient asset management. As an example by using a Geospatial AI approach, typically it can highlight the 30% of the network where a water company can expect 70% of leaks to occur. The degree of optimization achieved can be higher and depends upon the quality of the data supplied by the customer (Figure 15.1).

There are many benefits of geospatial AI for network operators, each described in the following sections.

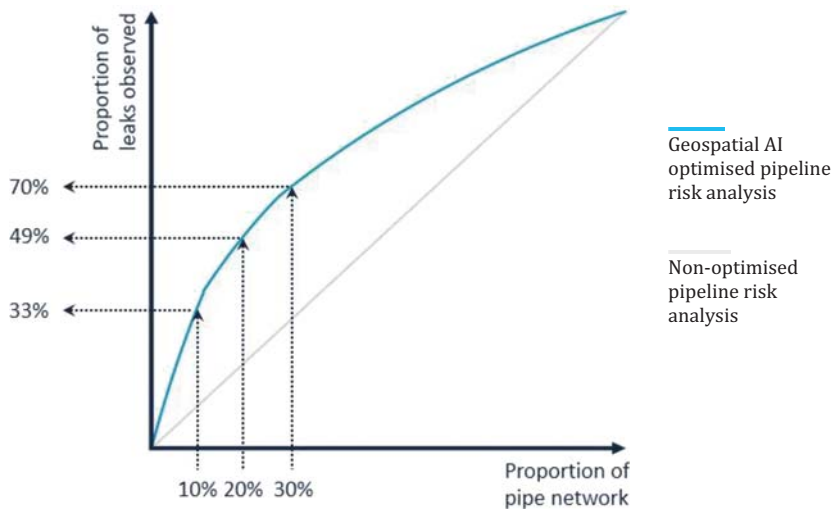

Figure 15.1 Prioritization and optimization of resources to manage pipeline network assessment. (Source: Rezatec)

15.1 LOGGER DEPLOYMENT

Geospatial AI is an efficient and fast way of figuring out the best disposition of sensors for optimal coverage of a given water network, identifying high-risk assets so that remote loggers can be installed selectively. Moreover, these decisions can be based on granular data about pipe material, size and consequence of failure. Not only does this maximise the effectiveness of logger deployment, placing them in spots with the highest risk of failure, but it also allows operators to invest in fewer loggers, thereby minimising not just capital expenditure but also operational expenditure, e.g. ongoing logger maintenance and access to data.

15.2 SURVEY PRIORITISATION

Another application of geospatial AI is survey prioritisation. Data analytics can produce failure risk maps and priority risk zones that are regularly updated and show the probability of failure of all network assets. Operators can use these insights to trace leakages, plan inspections or prioritise maintenance, optimising in-field surveys in terms of both time and cost, and ultimately allowing early interventions that reduce leakages and water loss.

15.3 CONSEQUENCE ANALYSIS

Analysis can be further improved by incorporating additional geospatial datasets and earth-observation satellite data in order to identify the specific conditions under which network failures occur, mitigate high consequence risks, and digitise general knowledge and understanding of the network. This information can be used by key stakeholders to help alleviate environmental impact, prioritise pipeline repair and maintenance around other utility works, and assess and manage risk to vulnerable buildings and other infrastructure assets. Additionally, water utilities can better manage costs associated with standard service measures such as interruption of supply, disruption to traffic and internal flooding.

15.4 CONCLUSIONS

Geospatial AI combines remote sensing and data science to identify the conditions under which network failures occur and to quantify the likelihood of failure across networks. By identifying which sections of a network have a higher likelihood of failure, network operators can concentrate their ground survey teams and IoT sensors on those high-risk areas and optimise their repair and monitoring work, thereby both preventing leaks and reducing the cost and time to find established leaks. Additional geospatial datasets and earth-observation satellite data can also be incorporated into the analysis to further mitigate high-consequence risks and to digitise general knowledge and understanding of the network.

Chapter 16

Method Z – Customer-side leakage using temperature and vibration

16.1 INTRODUCTION

Over the past 20 years, the cost and size of sensor technology has decreased dramatically. This has paved the way for the water industry to synthesise low cost, reliable sensors and leak detection. High-level leakage targeting is often based on principles developed in the 1990s using the BABE (Breaks and Background Estimate) methods that were based on UK water industry. These are the basis of the ILI (Infrastructure Leakage Index) that is in widespread use nowadays.

As our leakage management has improved over the years, we have reached a limit of detectability, known as background leakage. Background leakage refers to the “undetectable” level of leakage in the distribution network, large numbers of tiny leaks in the mains and service connection infrastructure. The Unavoidable Annual Real Losses (UARL) formula used in the ILI calculation is weighted towards service pipe leakage.

In a recent study from the “UK leaky loos” project it was found that 10% of toilet leaks had leaks averaging 400 l/day. Another study from Winnipeg, Canada found that 9% of toilets were identified as having a leak. In Hervey Bay, Australia, a study showed that the average leakage rate of a leaking residential property was 30.8 l/h. A Californian water-use study indicated that 7% of properties had a water loss in the property >350 l/day.

Typical leakage values assigned to night flow (in the UK at least) are approximately 0.5 l/prop/h for leakage inside the property, in case there are no customer meters (dripping taps, leaky shower heads, leaky toilet cisterns, etc.). The UK Managing Leakage reports suggest a default average value for Night use of 1.7 l/prop/h in the absence of any actual data.

Traditional customer-side leak detection is carried out using an acoustic method, where a leakage technician deploys a ‘listening stick’ to a stop tap and will identify a distinct sound corresponding to the

sound of the leak. This method has its advantages and disadvantages, with the main advantage being the speed of deployment and leak identification.

16.2 CUSTOMER-SIDE LEAK DETECTION FROM TEMPERATURE MEASUREMENTS

A method developed in the UK is to use temperature as a means of leak detection in customer pipes, while also assessing customer use. If a tap is turned on during a warm summer day, it is noticed that the water coming out of the tap is quite a bit colder than the ambient temperature. Water is generally kept within a temperature range of around 5 to 15°C (where 19°C is considered the 'limit' at which customers begin to complain) to prevent microbial growth in the water and to balance the chemical and mineral deposits. The temperature in the mains is generally different to the local air/ground temperature. When cooler water flows through a mains pipe, it is typically travelling quite fast, 0.1 to 0.3 m/s in typical ranges. At this speed the water in the mains does not get a chance to collect the energy (heat) from the soil around it, and so it remains cold by the time it gets to the tap. In the winter months, the opposite occurs, where the ground temperature is cooler than the water in the mains. At speed, the water does not lose its heat into the surrounding soil.

Figure 16.1 demonstrates the temperature effect on the stop tap when water flows through it. When there is no water flowing, the sensor will register the same temperature as the ground around it. When a water use event occurs, the temperature of the stop tap will rapidly decrease (or increase if the ground is colder). Once the use event has ended, the stop tap will return to its stable ground temperature again. Therefore, if there is a continuous leak in the house, the temperature difference between the ground and stop tap shall be significantly different (Figure 16.2).

The technique has been applied widely in the UK since early 2015, and data collected has been used from thousands of properties to develop automatic algorithms to process the results. The system comprises a sensor attached to the stop tap, a data logger, a cloud hosted database, and software to process the raw data and produce the results. The algorithms estimate the continuous flow due to leaks, as low as 1 l/h, and the intermittent flows due to use events. These are combined into a 15-minute average flow rate for each property surveyed. Loggers are left in place for between 24 hours for leak detection, and 7 to 14 days for consumption monitoring.

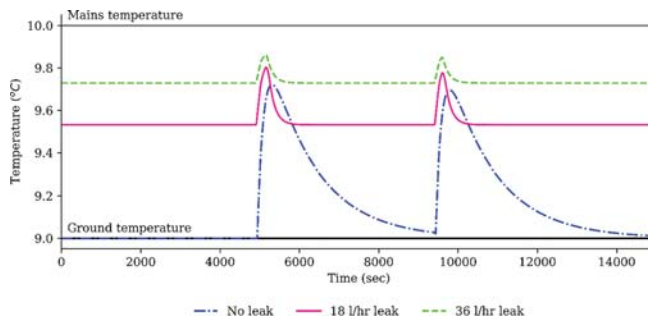

Figure 16.1 Simulated temperature data from stop tap with various continuous flow rates. (Source: Stuart Trow)



Figure 16.2 Device used for temperature measurements. (Source: Invenio Systems)

16.3 VIBRATION MEASUREMENTS FOR FLOW DETECTION

In order to speed up the rate of undertaking customer-side leakage surveys across whole areas, a vibration-monitoring device has also been developed (Figure 16.3). The device comprises two vibration sensors: one placed on the external stop tap; and a second used to take a background measurement. The hand-held unit takes simultaneous 30 second measurements from each device and stores them in its memory which can store up to 256 sets of readings, each of which is date and time stamped and GPS referenced. This enables productivity of the operations to be monitored and for the results to be displayed geographically.



Figure 16.3 Vibration recorder. (Source: Invenio Systems)

At the end of each day, or at intervals during the day the data is downloaded from the device and uploaded to a database where algorithms analyse the data and give each stop tap a result as follows:

- (1) Definite flow at the time of measurement
- (2) Probable flow
- (3) Possible flow
- (4) Definite no flow
- (5) Problematic recording

This technology detects the low frequency vibration of the water flowing through the stop tap and can detect small leaks that make little or no noise detectable by traditional methods and leaks that are remote from the stop tap where the leak noise does not travel to the stop tap. The technology does not rely on the human ear or the experience of the operative, it is simple to use and therefore training needs are low. It tracks the progress of the survey in time and space and it keeps the recordings in the database for retrospective checking and to improve the data analysis through machine learning.

Chapter 17

Case studies

17.1 NEW BRAUNFELS UTILITIES (NBU), TEXAS, USA CUTS WATER LOSS BY 50%

Justin Robinson, Marketing Manager, HWM

Abstract

Texas-based New Braunfels Utilities (NBU) used a range of leak detection equipment manufactured by HWM to build an efficient maintenance program for its distribution network while drastically reducing water loss. The equipment has allowed NBU to conduct scheduled repairs on its pipelines instead of dealing with leaks on an emergency basis.

Introduction

The NBU leak detection and valve maintenance program was established in 2009 to reduce water loss and increase system and valve reliability for NBU's 734 km of pipeline and 24,000 customer connections.

Problem description

At the end of the first year of the program, NBU calculated its average water loss at 4,700 l/km/day.

Solution provided

Recognizing the need for improvement, NBU used HWM leak detection equipment including Xmic ground microphones, SoundSens "i" correlating noise loggers, a MicroCorr Touch leak noise correlator and Permalog acoustic leak noise data loggers.

Permalog data loggers attach magnetically to pipelines and use advanced algorithms to discern the acoustic signature of leaks from background noise. SoundSens “i” and MicroCorr correlators (which are known as TriCorr in the US) analyze data from acoustic sensors to approximate a leak’s location. The Xmic electronic ground microphone amplifies noise generated by water escaping from buried supply lines under pressure, allowing users to pinpoint a leak’s position.

The team began using this equipment to perform preventive maintenance on 750 valves per year and proactively scan the city for non-surfacing leaks.

Results obtained

After two years, NBU estimates its average water loss at 1760 l/km/day, which is less than half the loss rate during the program’s first year.

“Everyone knows that water is a precious resource and its preservation requires a ton of attention,” said NBU Operations and Maintenance Division Manager.

17.2 ‘LIFT AND SHIFT’ LEAK MONITORING REDUCES LOSSES AND COSTS FOR VEOLIA WATER

Justin Robinson, Marketing Manager HWM

Abstract

Veolia Water has been making use of recent developments in water leak detection technology to effectively manage water networks with increased efficiency and at lower cost. HWM’s Permalog+ noise loggers have been used by the company in a ‘lift and shift’ method to quickly, easily and accurately detect leaks which their technicians can then repair.

Introduction

Veolia Water wanted to survey, in order to identify leaks, fifteen of their District Metered Areas (DMA), containing approximately 28,000 properties.

Problem description

The speed and effectiveness of the search for leaks in a large area is crucial in minimising waste and reducing Non-Revenue Water (NRW) levels because it determines the speed with which any identified leaks can be repaired. Therefore, the nine technicians involved in the project required a solution that would enable the best use of their time and resources to cover the largest possible area in the shortest time possible to effectively ‘audit’ the network for leaks. Time lost is water lost.

Solution provided

The company decided to use Permalog+ leak noise loggers to identify leak areas within the network. Mounted directly onto the pipes by a strong magnet, and battery-powered, the loggers monitor the section of piping around them for the sound of water escaping under pressure.

The loggers were used in “lift and shift” deployment mode to survey the network quickly and efficiently. This enables operators to deploy loggers, quickly identify potential areas of leakage and then re-deploy the loggers into another area.

Permalog+ loggers in “lift and shift” mode are configured to only transmit data when an operative swipes them with a magnet. There is no radio interference from other loggers, and the data is kept both secure and compartmentalised. This is useful when the same loggers will eventually be deployed in many different locations.

Using the system, the operator automatically recorded each deployed logger’s serial number and location by GPS tracking. This made deployment very quick, and there was danger of misplacing loggers – or any physical maps – this also naturally improved the retrieval time.

Leakage Teams deployed loggers throughout the targeted area where they remained overnight. The following day, the loggers were collected by the team, and a record made of any leaks identified in a specific location. The loggers were then deployed to a new area. In this way, the team was able to conduct a rolling, sweeping search for leaks quickly throughout the network.

Results obtained

Veolia Water reported excellent results from the operation, finding leaks with great speed and ease, leading to reduced costs from resources. The fifteen DMA’s containing approximately 28,000 properties took the nine leakage technicians only 32 days to sweep. In that time 96 leaks were identified.

Each technician, working alone, was able to deploy and collect over 80 loggers a day. The new GPS mapping technology gave the company an audit trail of loggers, allowing them to track the work of each technician and locate the position of each logger precisely. The deployment rate was the highest yet seen, and the speed of the activity enabled detection time to be reduced when compared to other leak-finding technologies and methods.

17.3 LEAK NOISE CORRELATOR AND GROUND MICROPHONE TECHNOLOGY USED IN ZIBO CITY, SHANDONG, CHINA TO PINPOINT LEAKS IN THEIR NETWORK

Justin Robinson, Marketing Manager, HWM

Abstract

The Zibo City Water Company in Shandong Province, China, recently used HWM’s MicroCorr Touch leak noise correlator to pinpoint a leak on a pipe in a busy urban area.

Introduction

Leak noise correlation is a proven method to pinpoint leaks on underground water pipes. The correlator measures the time difference at which leak noise is received by sensors deployed at either side of the suspected leak. Leak noise travels at a constant velocity, which depends on the material and diameter of the pipe. As a result, the time difference between the arrival time of the leak noise at each sensor, combined with the velocity, enables the location of the leak to be accurately pinpointed – often to within a few centimetres. The water company knew that there was a substantial underground leak on a section of pipe approximately 140 m long, made of ductile iron material. The diameter of the pipe was 500 mm and it was located in an urban area.

Problem description

The cost of urban road excavation is very high and so the leak must be precisely pinpointed to carry out the excavation. Most traditional correlators provide default filter settings for a wide range of different pipe

materials and sizes. However, due to the number of unknown variables that can change the frequency of leak noise, default filter settings will never be optimised for every leak situation. Experienced users can manually change the filter settings to find the leak, but this is often a time consuming process involving multiple correlations. Even then it can be “hit or miss” to successfully locate the leak.

Solution provided

The water company used HWM’s MicroCorr Touch leak noise correlator which uses accelerometer sensors of unparalleled sensitivity in the marketplace. In addition, the correlator incorporates a unique automated filter intelligence system (AFIS) which automatically runs 55 different filter combinations on the data, checking the quality of the result and optimising the filter settings as required, until the most accurate result can be determined. Working on live or pre-recorded data, tests have shown AFIS to significantly improve leak pinpointing on almost any pipe.

Results obtained

When the MicroCorr Touch was deployed it immediately identified the leak and then determined its position to within 0.1 m. The accuracy of the result was confirmed by using an Xmic ground microphone to listen to the sound of the leak above ground at the precise location specified by the correlator and this was confirmed by the subsequent excavation.

17.4 REDUCING LEAKAGE AT THAMES WATER

Antony Green, Vice President, GL Industrial Services

Abstract

Thames Water Utilities Limited (TWUL) is actively managing their water leakage to meet the targets agreed with the Office of Water Services (OFWAT). It is also imperative for TWUL to reduce the existing leakage levels in the most economical way possible. In 2010, TWUL appointed GL to provide leakage consultancy services, to support TWUL in leakage assessment and identification.

Introduction

Following a number of successful projects using GL’s burst finding technology within TWULs leakage management program, this project made use of the General Packet Radio Service (GPRS) to transmit data from the pressure loggers to provide increased access to field data and enable increased analysis frequency to identify unexplained anomalies and system leakage. 25 District Metered Areas (DMAs) were evaluated in the North East, Central and West London Zones.

Problem description

For each of the 25 DMAs identified by TWUL, GL were required to produce a report and presentation for each DMA identifying areas of interest for field investigation and possibly repair works, and then produce final reports and presentations detailing the findings and the success rate of the whole project.

Solution provided

DMAs with high leakage or demand irregularities were identified by TWUL and handed to GL for analysis. Data handover includes hydraulic models, GIS maps, and Bow data. Hydrosave, GL’s sub-contractors, carried out initial leakage surveys and deployed GPRS pressure loggers at specified locations in the

DMA. Pressure data was downloaded remotely via GPRS network using software provided by Halma Water Management.

The hydraulic model was assessed and updated based on the current GIS and Flow data and was then prepared for the “Burstfinder” analysis with the logged pressure data as reference pressures.

“Burstfinder” was run to recalibrate the leakage component of the demand against the current logged pressure data. It provides an ‘automated’ approach using optimisation to match the chosen variables against the field data.

All results were reviewed and areas of interest assessed to identify anomalies and areas for further investigation in the field. Leakage technicians then carried out leak detection in all areas of interest in the field to confirm the cause of the ‘hotspots’ for example new demand, leak and so on. All identified leaks were communicated to TWUL for follow-up validation and repair.

Results obtained

The study results have shown that the “Burstfinder” is highly effective in locating leakage hotspots and significantly improved the performance of leakage teams.

Through the use of GPRS pressure loggers GL was able to deliver a far more efficient service and provide a full comprehensive set of results against a targeted DMA programme.

GPRS loggers provided near real-time pressure data, which enabled the network to be monitored continuously and remotely for increased efficiency and faster response time.

The use of “Burstfinder” enabled GL to proactively direct detection teams to street locations within a DMA, to detect leakage and improve the ESPB rate per FTE and MLD found per FTE

The use of GPRS loggers allowed repeat analysis to be done instantly after detection or repairs, to allow additional hotspots to be identified within the DMA.

GL also developed a new form analysis that enabled the identification of demand anomalies and a street location and time period be highlighted for onwards investigation. (Figures 17.4.1 and 17.4.2)

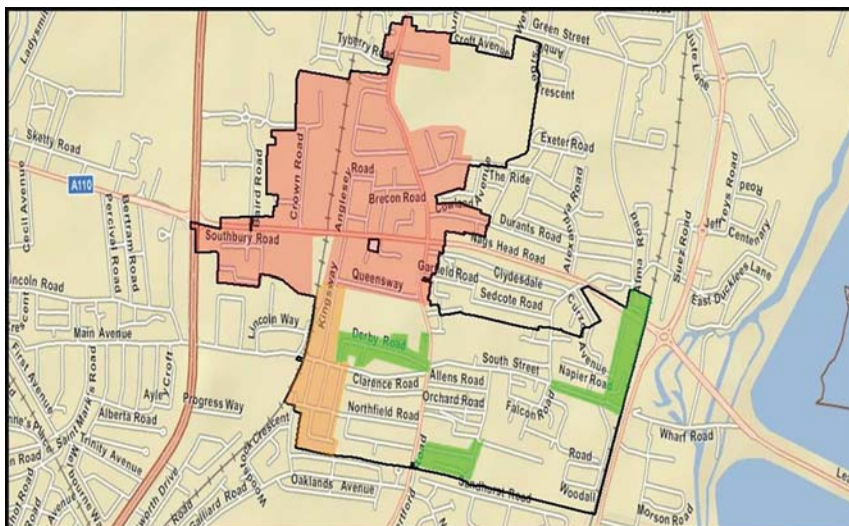

Figure 17.4.1 Output example from the simulations detailing ‘hotspots’ in DMA Sewardstone 38. (Source: GL Industrial Services)



Figure 17.4.2 Confirmed leaks identified by “Burstfinder”. (Source: GL Industrial Services)

17.5 LEAK DETECTION FOR ANKARA WATER AND SEWERAGE ADMINISTRATION (ASKI)

Stephen Rothwell, Marketing Specialist, Pure Technologies

Abstract

Ankara Water and Sewerage Administration (ASKI) completed a successful SmartBall[®] survey of a portion of its large diameter water transmission main that serves the capital city.

Introduction

Ankara Water and Sewerage Administration (ASKI) serves about 4 million customers with water in Ankara, Turkey’s capital city, and operates more than 10,000 km of water transmission and distribution mains, including over 700 km of large-diameter mains (500 mm and above). The utility wanted to check the condition of one of its large-diameter transmission that is essential in supplying Ankara with water. This particular main, called Ividik-T17, is made of 2200 mm pre-stressed concrete cylinder pipe (PCCP) and is about 35 years old.

Problem description

Before beginning the leak detection survey, ASKI was struggling with a high rate of water loss per month, with about 36 percent of its pumped water lost. These losses can be attributed to leaks, illegal connections, unbilled water use (fire hydrants etc.) and flushing of the pipeline system. While not all of the 36 percent loss was a result of leaking pipes, the utility was concerned nonetheless and estimated that 80 percent of the losses were a result of leaks. Another consideration for ASKI was the condition of this pipeline; the transmission main was over 30 years old and is a crucial supply of water to its Ankara. Because it has no redundancies that would allow the pipeline to shut down for repair, ASKI wanted to understand

the condition of Ividik-T17 to proactively plan contingency measures and potential repairs for one of its major pipelines.

Solution provided

To inspect the transmission main, ASKI used SmartBall, a free-swimming tool that traverses pressurized pipelines locating and recording acoustic activity associated with leaks and pockets of trapped gas. The tool can be inserted into pipelines of any material while the line remains in service and travels with the water flow for up to twelve hours, meaning it is able to survey long distances in a single deployment. Because the tool creates no noise, it is able to locate leaks that are very small, and has location accuracy typically within 3 m or closer to the actual leak. For the 15 km inspection of Ividik-T17, there were 17 SmartBall Receiver (SBR) locations placed along the pipeline. This allowed for accurate tracking of the tool as it traversed the pipeline. The SmartBall was inserted at a 150 mm gate valve located shortly after a water treatment plant and was extracted at a reservoir. The 15 km SmartBall inspection focused on the highest-risk portion of the PCCP pipeline and was completed in November 2011.

Results obtained

The results of the inspection were very positive for ASKI. The SmartBall located 10 total leaks along the Ividik-T17 transmission main, one of which was very large. The large leak (Figure 17.5.1) was causing a loss of 50,000 cubic metres of treated drinking water per year, with an estimated financial loss of \$75,000. This particular leak was caused by a leaking valve beneath the ground, with the lost water finding its way to a river. ASKI was able to fix this leak shortly after its discovery. In addition to the large leak, nine other leaks were found, six of which were located on pipeline features (valves etc.), while only three leaks were located on the actual pipeline. The location of most of the leaks on pipeline features was also positive for ASKI, as it showed that the condition of the transmission main was fairly good. As Ividik-T17 has no redundancies, most of the leak repairs have been postponed until an alternate transmission main is built to supply.



Figure 17.5.1 Leak located in excavation. (Source: Pure Technologies)

17.6 LEAK DETECTION PROGRAM IN MANILA, PHILIPPINES

Stephen Rothwell, Marketing Specialist, Pure Technologies

Abstract

Maynilad Water Services Inc. (MWS) in Manila, Philippines, began a comprehensive leak detection program to help the utility deal with their Non-Revenue Water (NRW) problem.

Introduction

MWS is the water and wastewater services provider for 17 cities and municipalities that comprise the West Zone of the greater Metro Manila area, operating about 6000 km of pipeline in the area. The leak detection program began in January 2010 and is an ongoing effort addressing NRW in Manila. The initial contract between Pure Technologies and Maynilad was signed in 2009 as part of a strategic water loss management program aimed at reducing water loss. Under this contract, Maynilad engineers were trained on Sahara[®] technology to operate the equipment in the West Zone concession. MWS initially rented two Sahara units for ongoing use, but have since reduced to one unit with both audio and visual capability. Pure provides Sahara technical support, maintenance and parts as needed for the utility.

Problem description

Before the beginning of the program, the utility was facing a significant NRW problem, particularly with leaks not visible at the surface, illegal connections, and unknown laterals and old service connections that were unaccounted for. Presumably, many of these problems went unnoticed for a long period of time because they were not visible at ground level, causing significant water loss and fiscal impact.

Solution provided

To address the problem, the client used a tethered leak detection tool, Sahara, which is ideal for urban areas like Manila that have complex interconnecting networks. Pipeline inspections using Sahara are conducted while the main remains in service by inserting a sensor into any tap 2 inches or larger. A small parachute uses the flow of water to draw the sensor through the pipeline. The sensor is tethered to the surface, allowing for real-time results and maximum control and sensitivity as the tool can be pulled back and forth to re-inspect certain areas. The surface tracking device allows the position of leaks and other pipeline features to be located to within 46 cm (18 inches). Depending on pipeline features and flow velocity, the inspection distance can be up to 2 km. Sahara Video, which runs concurrently with the leak detection inspection, allows CCTV inspections on pipelines while they remain in service. Sahara video has been used to assess the condition of pipeline interiors, locate known features with unknown locations, and locate unknown features, including unknown laterals and illegal connections along the inspected pipelines.

Results achieved

The leak detection program allowed MWS to establish the condition of their pipeline, which has helped optimize their repair and replacement programs and allowed them to maintain their service to customers. Since the start of the program, 264 km have been inspected with 319 leaks located and 173 illegal connections or unknown laterals identified and shut down. Initially, Maynilad was only doing leak detection using Sahara audio, but have since adopted video as well. A combined audio and video program has helped MWS detect leaks, but also see video anomalies, such as obstructions, protrusions, gas pockets, illegal taps and unknown laterals and valves.

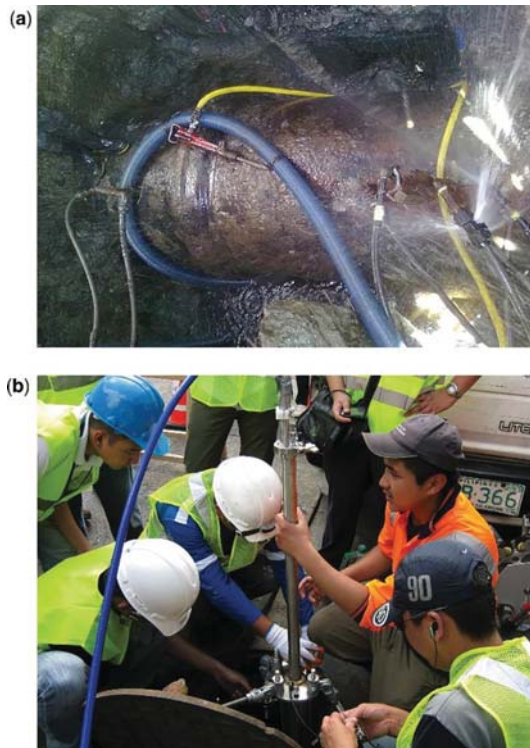

Figure 17.6.1 (a) Illegal connections found on excavation, and (b) staff training in use of equipment. (Source: Pure Technologies)

17.7 LONG DISTANCE LARGE PIPELINE INSPECTION

Fabio Orland, Commercial Director

Abstract

A large European water supply company, decided to undertake a pilot pipeline inspection project to monitor several strategic trunk mains for leakage and condition assessment located within its extremely busy town centre.

Introduction

The company serves approximately 4 300 000 customers through an extensive network of 2 million water meters and 9 500 km of water pipes.

The pipeline inspection programme began in July 2012, and lasted 6 weeks to cover a total distance of 15 km. The programme delivered the client full CCTV inspection, and also a full leakage sweep of the network.

Problem description

Prior to the project commencement, the clients understanding was that there was not a big issue with leakage due to the ground structure in and around the city, this being very clay rich, in theory would

bring all leaking water to the surface. However, due to the importance of the specific mains and the fact that they have been in service for over 30 years without inspection it was decided that an in-line survey would be carried out to establish a baseline for condition assessment and look for any leaks at the same time.

Solution provided

The company decided to use the LDS 1000 which comprises a tri-technology head, this being a high resolution colour camera, hydrophone and high powered sonde to give the operator live video and audio feedback during an inspection. The neutrally buoyant cable is then floated within the pipeline utilising the water flow.

The system enters a pipeline via a 2 inch tapping, and is fully chlorinated during its insertion; the system works on a live basis, with no interruptions to the clients services, and can cover a distance of up to 2 km per day.

The technology is the latest trunk main inspection system on the market being fully battery powered and only requires a two man team for its implementation.

Results obtained

A total of 15 km of mains were inspected ranging from 400 to 700 mm in diameter. A total of 15 substantial leaks were detected, verified and repaired during the project, along with several objects of interest discovered. Images below show one of the items of interest discovered during the inspection project a piece of timber which was 2.7 m long.

The LDS 1000 was also used to update the clients GIS system by identifying numerous unknown bends, lateral connections and paved over valves, along with validating the condition of existing repairs.

The project was very demanding, as the city is very heavily populated with large volumes of traffic. Due to the LDS 1000 being powered off batteries, the system was charged throughout the day, this enabled us on several occasions to work through the night with silent work operation and with far less traffic. The LDS 1000 has also been successfully used in Canada, Jakarta, Georgia, Mexico, New Zealand and the USA.



Figure 17.7.1 Team operating JD7 LDS1000 in Greece. (Source: JD7 Ltd)



Figure 17.7.2 Length of wood located and removed from main. (Source: JD7 Ltd)

17.8 POTABLE WATER PIPELINE INSPECTION IN NORTH AMERICA

Fabio Orlandi, Commercial Director

Abstract

JD7 Pipeline Services were recently mobilised to Canada for a pipeline inspection project to assist a contractor in locating possible leakage problems in a newly laid pipeline.

Introduction

The contractor is one of Ontario's largest and specialises in major road, highway, sewer and water main projects and has undertaken a five mile road rehabilitation and water main/hydrant replacement project. The City is one of Canada's fastest growing municipalities, and is located just north of Toronto.

Problem description

The project is significantly behind schedule due to repeatedly failing hydrostatic pressure tests required for certification by the local utility. The pipeline, a 6 inch PVC C900 pipe with 5 bar pressure using Cobra Locks, was installed using trenchless directional drilling to reduce disruption to a now established neighborhood.

The contractor outsourced local specialist pipeline inspection companies, and searched for leaks over a four-week period using noise correlators and vacuum excavation joints. With the former no leaks were identified whilst with the latter five leaks were detected. However, this was very intrusive and also costly "guess work". The estimated cost over a four-week period of failed inspection/leak detection was very high, at about £300 000.

This had a major knock on effect, as the client could not proceed with service hook-ups and road paving until the hydrostatic test is passed on all locations, this also incurred a daily fine issued by the local utility company.

Solution provided

The "Investigator" by JD7 was used to provide an in-line of the pipeline. It has been designed and developed for small distribution mains, sizes 3–12 inch. The system comprises of a tri-technology head, this being a high resolution colour camera, hydrophone and high powered sonde, tethered to a 100 m semi rigid rodding to give the operator live video and audio feedback during an inspection. The system enters a



Figure 17.8.1 (a) and (b) Leak located on MDPE electro-fusion joint, (c) located joint on MDPE pipe where leak detected. (Source: JD7 Ltd)

pipeline via a 2 inch tapping, and is fully chlorinated during its insertion; the system works on a live basis, with no interruptions to the clients services, and can cover a distance of up to 1 km per day. The technology is the latest live main inspection system on the market being fully battery powered and only requires a two man team for its deployment.

JD7 Pipeline Services completed the inspections in 10 working days, and in total successfully identified and located 10 leaks all verified when excavated.

Results obtained

The following results were obtained following the deployment of JD7 Investigator.

The Investigator™ identified 10 leaks during the project, all were later validated. The tethered insertion technology system allowed for precise location of the leaks to be identified. The acoustic system is very sensitive and able to pick up small and large leaks. An operator was able to identify multiple leaks in close proximity to each other. This is the only technology that precisely locates leaks in PVC pipe. The contractor passed the hydrostatic tests at a fraction of the cost and time they invested in previous weeks using various other methods. The Investigator has also been successfully used in Jakarta, Georgia, Mexico, New Zealand, UK and the USA.

17.9 A FULL-SCALE ACTIVE LEAKAGE CONTROL PROJECT FROM A CHINA WATER UTILITY

*Wenxu Wang, General Manager, Yunnan Kan Zheng Water Loss Control & Engineering Co., Ltd.
Yuxi Wang, General Manager, Beijing Fujitech Instrument & Equipment Co., Ltd.*

Abstract

The leakage rate of a China water utility was successfully reduced via a full scale Active Leakage Control strategy. Numbers of key steps were involved in this project. Several leak points from various types of conditions were pin-pointed via acoustic methods.

Passive vs. active

Passive leakage control

For most of the counties and towns, and even in some main cities, the main water loss control method is still 'Passive Leak Control'. Under this scenario, water utilities only source for water leak detection crews when they find a dramatic decrease in network pressure or lack of water supply to the users. The process of 'sensing' a potential unreported leak is very time consuming, therefore costing lots of physical loss within the network. In China, passive method will usually take at least 10days to discover the leak, find the leak and fix it.

Active leakage control

The 'Action Plan for Prevention and Control of Water Pollution' has clearly set out the target that the national leakage rate has to be beneath 12% in year 2017, and 10% in year 2020. The ALC strategy is one of the key parts to reach this target. There are six basic steps for conducting an ALC project:

- (1) Check out the entire underground pipeline and other buried assets. Make a detail water pipeline diagram.
- (2) Divide the network areas into different 'blocks', if condition allows, make DMAs.
- (3) In-time monitoring the entire network by installing flow meter and pressure meter on water mains and branch pipes.
- (4) Find high leakage potential area based on the variation of flow rate and pressure data
- (5) Setup the water leak detection team or calling contractors
- (6) Pinpointing the leaks and fix the leak point

Active Leakage Control only takes 2 days to discover, find and fix a leak in China.

Problem description

One living area was suffering a long-term water shortage and weak water pressure. Due to the underground material of area is entirely covered the quaternary high-clay soft soil, routine acoustic surveying work is hard to conduct. Meanwhile, the entire network system is 'dumb'. Utility wants to become 'smarter' in terms of network operation and water loss management.

Solution

Yunnan Kan Zheng Water Loss Control & Engineering Co., Ltd decided to provide a full-scale Active Leakage Control solution to this water utility.

17.9.1 Step 1. DMA Planning

Via detailed pipeline locating procedure, the entire water pipeline of this project area was surveyed. All the necessary information including burial depth, pipe material, pipe diameter, etc was integrated onto a single CAD map (Figure 17.9.1). The project area was divided into five different DMAs. (Figure 17.9.2).

17.9.2 Step 2. Flow and pressure monitoring

Numbers of remote flow-meters and pressure meters were installed at the strategic points. (Fig. 17.9.3).

In November 8th, the monitoring platform detected a potential leak event according to a sudden increase of flow rate and decrease of pressure. The alarm was sent to the manager's mobile phone via SMS. The SMS clearly show the following information:

In Figure 17.9.5, a DN315 PE water main pipe's flow rate was over the threshold value, and the pressure fell beneath the threshold value.

In the same time, the monitoring diagram was also sent to the manager's mobile phone. Figure 17.9.6 left is the water pressure drop, and right is the water flow increase.

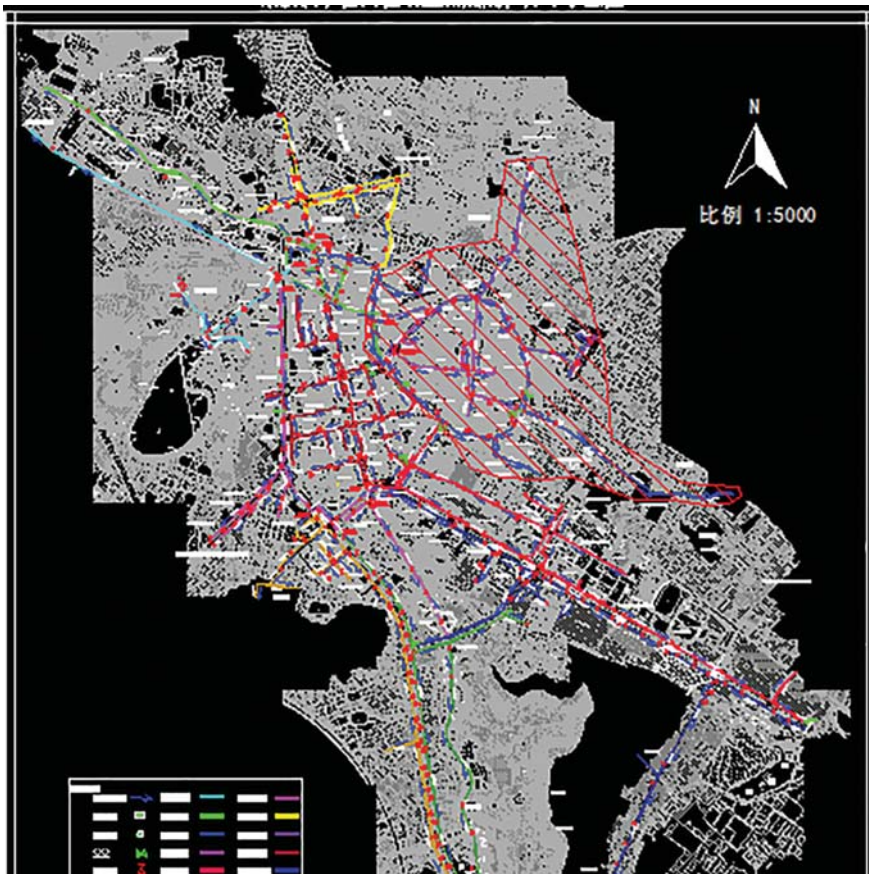

Figure 17.9.1 Network map. (Source: Yunnan Kan Zheng Water Loss Control & Engineering Co., Ltd)



Figure 17.9.2 DMAs. (Source: Yunnan Kan Zheng Water Loss Control & Engineering Co., Ltd)



Figure 17.9.3 Field work of metering devices installation and calibration. (Source: Yunnan Kan Zheng Water Loss Control & Engineering Co., Ltd)

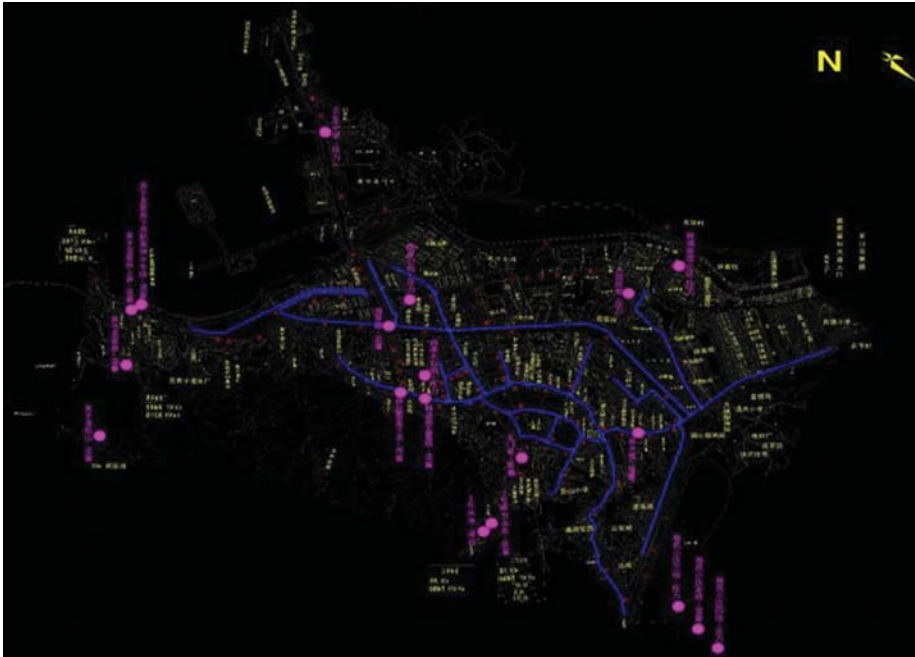

Figure 17.9.4 Overall monitoring points (in purple) in the project area. (Source: Yunnan Kan Zheng Water Loss Control & Engineering Co., Ltd)



Figure 17.9.5 SMS alarm. (Source: Yunnan Kan Zheng Water Loss Control & Engineering Co., Ltd)

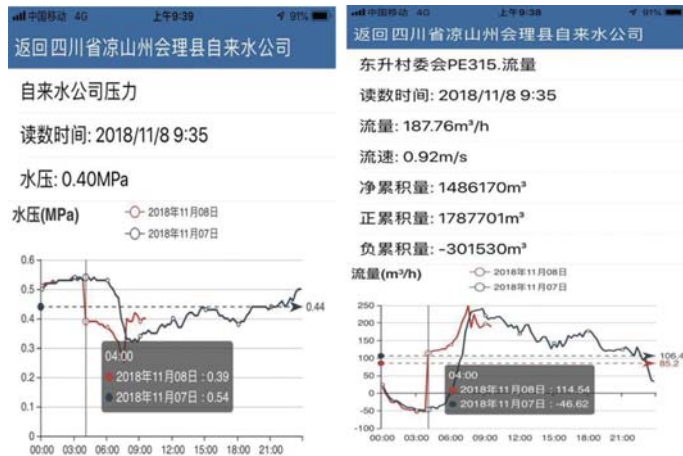

Figure 17.9.6 Monitoring result. (Source: Yunnan Kan Zheng Water Loss Control & Engineering Co., Ltd)

17.9.3 Step 3. Water leak pin-pointing

According to the information of the monitoring platform, a two-person water leak detection crew was sent out this area. The team was using FUJITECOM DNR-18 ground-microphones, FSB-8D electronic listening stick and LSVP1500mm listening stick to conduct an acoustic leak survey.



Figure 17.9.7 Leak point pin-pointing. (Source: Yunnan Kan Zheng Water Loss Control & Engineering Co., Ltd)



Figure 17.9.8 Leak point confirmation. (Source: Yunnan Kan Zheng Water Loss Control & Engineering Co., Ltd)

17.9.4 Step 4. Leak confirmation

The leak point was confirmed by excavation. As shown by Fig. 17.9.8, a 35cm long 8mm wide crack was found on this DN 316 PE water main. The water pressure on this pipe is 0.32mPa, therefore according to the formula: $Q=A \times C \times \sqrt{(2 \times g \times H) \times 3600s}$. The estimated water loss from this leak point is 151.46m³/hr.

17.9.5 Conclusion

It only took 3 hours from discovering the potential leak event to fix the leak point. The water was successfully saved via early in-time system warning and efficient water leak detection. In conclusion, ALC solution is able to sense and find leaks much earlier than Passive Leakage Control. With the combination of 'IOT' technologies, the time consuming is even further reduced.

17.10 REMOTE LEAK LOCATION TECHNOLOGY GIVES REDUCED LOSSES IN ANGLIAN WATER

Lisa White, Regional Sales Manager, Primayer

The challenge

Anglian Water have reduced leakage by 20% since 2010, have committed to a further 23% reduction by 2025. Overwhelmingly, customers have told Anglian Water that leakage is a high priority and that they want to see it reduced to well below the Economic Level of Leakage (ELL).

Fixed correlating noise loggers – the vision

To develop, own and utilise a system that enables cost effective, smart, real time leakage monitoring at an individual asset level for Anglian Water's entire network.

Trials in town of Louth, Lincolnshire, UK

Technology comparisons were performed over a total mains length of 40km, comprising mixed pipe materials. 800 traditional noise loggers were deployed every 50m at a cost of £250 per logger, totalling an investment of £200,000.



Figure 17.10.1 Installing Enigma3hyQ. (Source: Anglian Water)

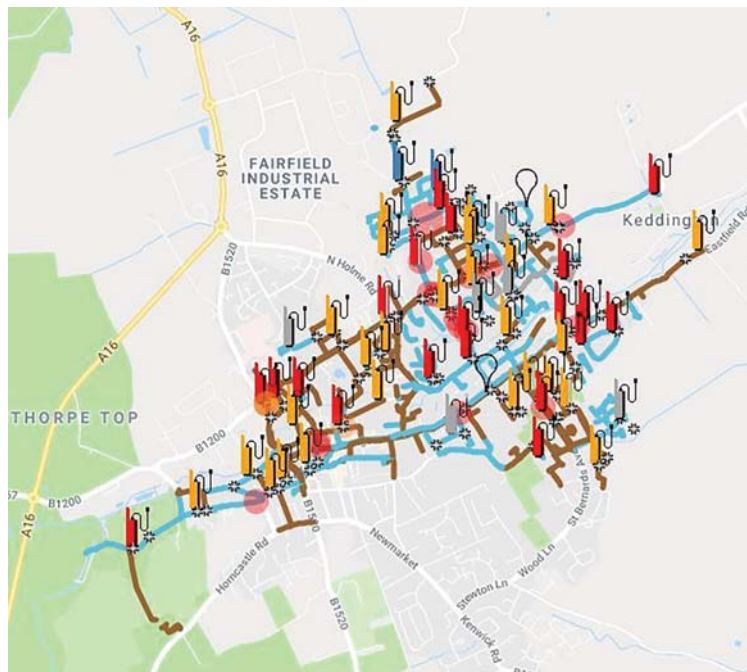

Figure 17.10.2 Location of loggers. (Source: Anglian Water)



Figure 17.10.3 Enigma3hyQ logger. (Source: Anglian Water)

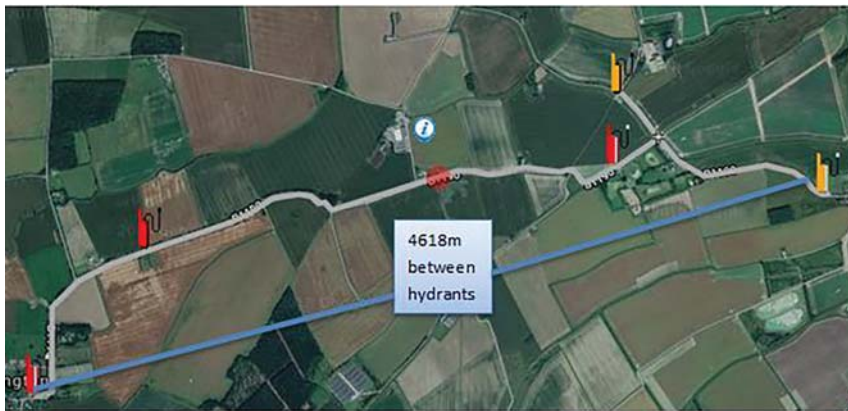

Figure 17.10.4 Leak detection distance. (Source: Anglian Water)

By comparison, 58 units of Primayer Enigma3hyQ's were deployed every 750m, at a comparative total cost of £69,600 (including installation of permanent sensor point) to cover the same area (Figure 17.10.4). This represented a 65% cost saving (when compared with traditional noise logging).

Further, the results given by the Enigma3hyQ's were demonstrably much better, with all units communicating, less 'false positives', zero theft and lower leakage levels (Figure 17.10.2). Challenges included the sites consisting of a large range of different materials, including but not limited to Cast Iron, Ductile Iron, Asbestos Cement, MDPE and PVC. Despite these challenging conditions, the Enigma3hyQ's provided repeated, accurate leak locations over distances of up to 4.6 kilometres (Figure 17.10.4).

Anglian Water have installed 2350 variants of Primayer fixed network technologies. They have ordered a further 3500 units of Enigma3hyQ for installation during the first quarter of 2019; the next phase of their overall leak reduction programme.

Advanced performance

- Optimised location over longer distances, plastic and trunk mains
- Multi-point correlation via cellular communications
- Accurate time synchronisation for leak position
- Simple installation with no above ground radio repeaters required
- Data available at any location via the internet
- Remote leak listening for confirmation of leak noise



Meeting the challenge

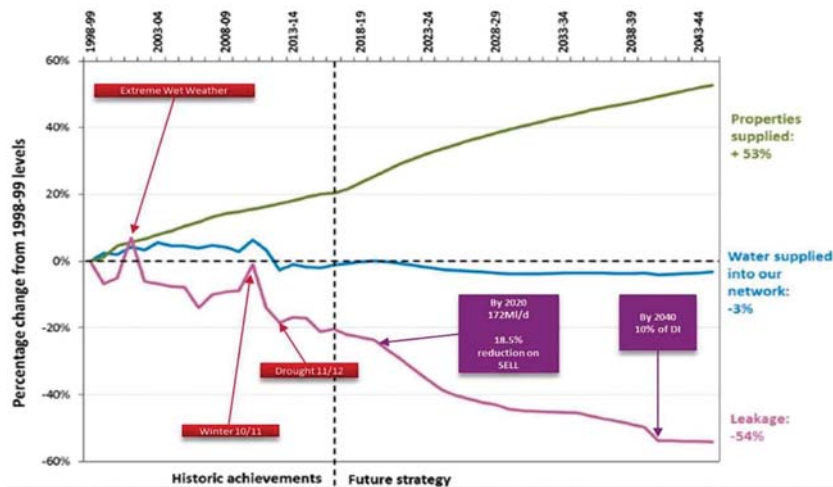

“One of the biggest challenges faced across the water industry is the ability to detect leaks effectively on plastic pipes as they don’t transmit noise when they leak. Critically, unlike more widely used methods, this technology can be used on plastic pipes, which make up 60% of our water mains.”

Andy Smith, Regional Optimisation Manager, Anglian Water.

17.11 LEAK LOCATED OVER 1458 METRE PLUS A SECOND LEAK TO HALVE THE NIGHTLINE

Roger Ironmonger, Managing Director, Primayer

Introduction

Bristol Water team working with RPS were tasked with identifying the source of significant water loss in the Beverston area of Bristol Water. The survey was carried out over approx. 4000 metres of rural cast iron main, with only 70 properties making it difficult due to length of main between fittings and difficult to find stop taps and meters. The nightline before the survey was 4000 l/h.

The challenge

Standard leak detection methods had been unsuccessful in the district before carrying out the Enigma survey. Enigma was chosen due to the difficulty experienced with radio signals over the long distances, the fact it was a lot of 60mph lanes making it unsafe for technician’s to be at, the roadside for long periods and the unnecessary work of continuously moving sensors to get the coverage.

Installation

The loggers were put out in the daytime, collected, analysed and followed up the day after making it productive. The use of Primayer’s Enigma off-line correlator proved to be a key factor in the safe and reliable installation in these difficult locations (Figure 17.11.1).



Figure 17.11.1 Enigma installation next to the A4135 highway. (Source: Primayer)

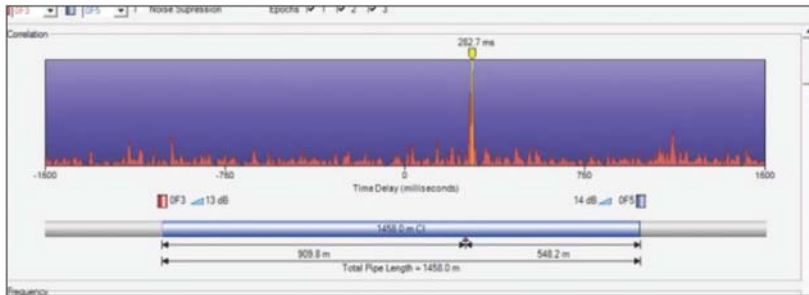

Figure 17.11.2 Correlation over a distance of 1458m that picked up a 1200 l/h leak on a private supply to Park farm. (Source: Primayer)

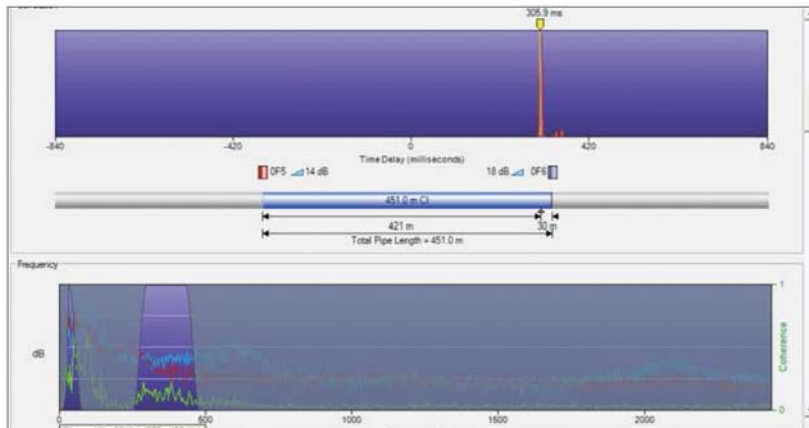

Figure 17.11.3 Second leak located in the main over 451 m. (Source: Primayer)

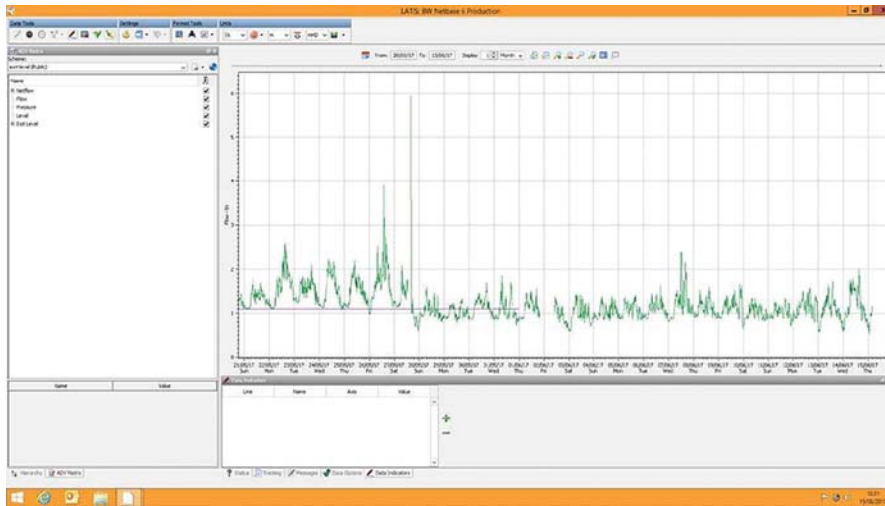

Figure 17.11.4 The nightline flow before survey was running at exit level of 1.1 l/s and after survey and repairs it reduced to 0.5l/s. Source – Primayer

Results

The correlation results showed a leak over a distance of 1458 metres on a private pipeline supplying a farm (Figure 17.11.2). This was subsequently validated as a 1200 l/h water loss.

A second leak on the A413 was located over a distance of 541 metres. This was filtered at two different frequency bands to reduce pump noise (Figure 17.11.3). This leak has been confirmed as 1000 l/h water loss.

Total water loss reduction after identifying and fixing these leaks has been from 4000 l/h down to a little under 2000 l/h (Figure 17.11.4).

“The Engima has proven an indispensable part of our leak detection toolkit. It’s found our needle in the haystack!” Gareth Ingram Leak Technician RPS

17.12 SYSTEMATIC LEAK REDUCTION IN ISRAEL – A ZONESCAN NOISE LOGGER PROJECT BY GUTERMANN

Uri Gutermann – Gutermann

This case study provides the background to one of the largest fixed monitoring projects in the world – an endeavor with the goal to significantly reduce Non-Revenue Water and increase transparency of the operational performance of the network.

Project background

Haifa – the multi-cultured “metropolis of the North”

Haifa is Israel’s third-largest city with a population of over 250,000. It is located in the very north of Israel, close to the border to Lebanon and beautifully situated on the shores of the Mediterranean Sea. The city is split over three tiers. The lowest is the center of commerce and industry including the Port of Haifa. The middle level is on the slopes of Mount Carmel and

KEY FACTS SUMMARISED:

Alpha Measurement Points by the end of the case study	340
Pipe km covered / monitored	150km
Leaks identified in 12 months	100
Annual water loss saved in 1 year	Ca. 1 million m ³
Reduction of NRW (in % points)	8%
Return on investment (per year)	320%



Figure 17.12.1 Panoramic view of Haifa. (Source: Gutermann)

consists of older residential neighborhoods, while the upper level consists of modern neighborhoods looking over the lower tiers.

Mei Carmel – a public utility “start-up” with big ambitions

Mei Carmel is a public corporation founded in 2010 as a spin-off from the municipal government with the aim to improving the public service level to the residents of Haifa. Mei Carmel is obliged to invest all of the excess profit in water and sanitation infrastructure. The entire pipe network amounts to a length of 580km (in 17 DMAs and over 100 pressure zones), the third largest network in Israel after Jerusalem (1200km) and Tel Aviv (800km). Mei Carmel buys the water from different sources, but mainly from the Israeli bulk supplier Mekorot. Every year, over 24 million cubic meters of water are processed and distributed to the 120,000 customers. The average customer price of water is around ILS 9-14 per cubic meter while the cost of production is about ILS 6. The estimated Non-Revenue Water (NRW) level before significant investments in technology and infrastructure was 17%, most of which comes from leaks. But this is set to change. Mei Carmel’s young Chief Operating Engineer (COO) Stav Avraham’s goals are clear: “The city of Haifa wants to be at the technological front line of the leakage solution field in Israel. Active leakage management greatly aids the corporation to save more water and also provide a much improved level of service for the residents.”

Why did Mei Carmel invest in leak monitoring technology?

In its first three years of operation, Mei Carmel had to focus on three main areas: (1) Urgent and emergency replacement of failing infrastructure; (2) Establishing systems of command and control information; (3) replacing 120,000 water meters. By the end of 2011 it became evident that even the large investment

Table 17.12.1 Non-revenue water. (Source: Gutermann)

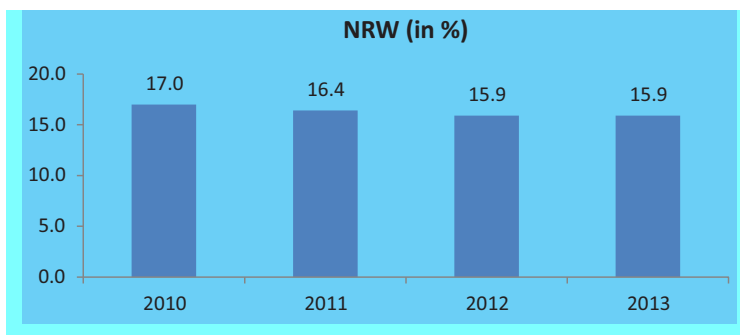

in pipe replacement did not resolve the NRW issue as expected: Despite an investment of EUR 20 million, the NRW rate only reduced from 17% in 2010 to 15.9% in 2012. How would Mei Carmel achieve its long term goal of 7% sustainable NRW?

Mei Carmel's management needed a fast solution – and quick! So the focus began to shift on leak detection. Mei Carmel had used fairly basic methods for leak detection before Stav Avraham and his team decided to invest in technology and approach the topic of leak detection in a more professional and sustainable way. In the past, Mei Carmel would react on a phone call from a customer reporting an open leak by sending in a leakage operative with sort of “stethoscope” or hire an external contractor to do the job for a flat fee plus bonus for any pinpointed leak. Going forward, Mei Carmel's approach would need to change fundamentally.

Haifa's integrated leak reduction programme

The evaluation phase

In 2012, when managers of Mei Carmel first came across Gutermann and ZONESCAN Alpha (at a specialist fair in Manila), they were unaware of the fact that ZONESCAN loggers can correlate, even in a fixed network installation. They quickly realized that this was a unique feature that their own loggers (from a German competitor) did not have. Within a few months it was decided that Mei Carmel would purchase a batch of ZONESCAN loggers and test them side-by-side against other products in the market (the abovementioned German product as well as another logger from a British manufacturer).

So in summer 2012 Mei Carmel commissioned a small test installation (40 measurement points) from GUTERMANN which were installed in two selected areas: Ramat Eshkol and Cababir.

Several challenges had to be overcome for the pilot:

- Mei Carmel was going to install – at the same time – an Automatic Meter Reading (AMR) product which would also require management attention
- Radio conditions are quite challenging as Haifa is spread out over a large area including cliffs, hills and valleys
- The water usage (and therefore potential saving) could not be quantified for the trial areas, since the monitored DMAs were not equipped with flow meters.
- Israel's radio regulations require a different radio frequency from the rest of Europe, which runs on the public frequency band 868 MHz. Therefore, GUTERMANN had to supply (and get approval from Israel's MOC) the less frequent 916 MHz frequency range.

Before the system was installed in August 2012, Mei Carmel sent in a leakage contractor to “clean the areas” and make sure that they were leak-free, something that would normally not be done in order to prove the product's effectiveness more easily. Six leaks were identified and fixed.

ZONESCAN ALPHA setup

ZONESCAN Alpha consists of loggers, repeaters, Alpha units and the cloud-based software ZONESCAN Net.

The most important element of a ZONESCAN Alpha installation is the choice of Alpha location. The Alpha has to be able to communicate with as many “associated” loggers as possible and guarantee a seamless radio communication in the whole network. Every logger records time-synchronised sound sequences plus additional data such as a noise level distribution, the sound spectrum and minimum and maximum temperatures, and transmits them via radio repeaters to Alpha units. The Alpha unit then transmits all the collected data to GUTERMANN's secure servers which automatically runs all the

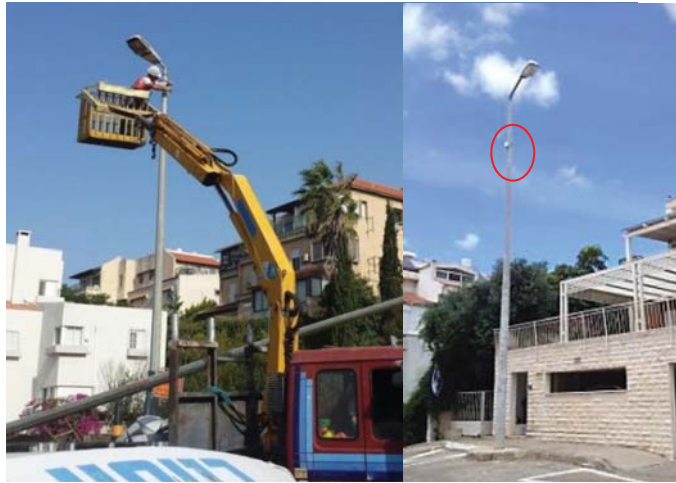

Figure 17.12.2 Alpha location on lamp post. (Source: Gutermann)

calculations such as correlations and leak alarms, and displays all the data on a Google Maps interface for the customer's convenience and his analysis in the office.

In the case of the Mei Carmel trial, GUTERMANN installed 40 loggers, 38 repeaters and three Alphas. For the installation of the Alphas, the installation team, led by Mei Carmel's operational team leader Reut Gotfrid assisted by Simon Fechter from GUTERMANN and Miki Schlesinger from Schlesinger Environmental Systems (the Israeli representative of GUTERMANN), had to be creative and use lamp posts in elevated locations as the topography of Haifa is such that many neighbourhoods do not provide for good natural "Alpha sites", ie. high installation points with good radio coverage of their respective monitored areas. Once good "Alpha spots" have been chosen, the correlating ZONESCAN 820 loggers can be deployed in distances from each other that allow for a correlation between each logger pair



Figure 17.12.3 Repeaters (in UPVC housing), PDA and Communication Link for installation, correlating loggers, Alpha unit. (Source: Gutermann)



Figure 17.12.4 Mei Carmel staff deploying a correlating logger. (Source: Gutermann)

(usually 150-350 meters). If necessary, a radio repeater will ensure optimal radio connectivity from the logger to the Alpha unit. Such repeaters will usually be installed on top of a lamp post near the respective logger location.

In [Figure 17.12.4](#), a Mei Carmel staff member is deploying a logger using a PDA equipped with ZONESCAN Mobile, the Windows-based ZONESCAN Alpha installation software. On the ground next to him, ready to be deployed next, is a (shorter) ZONESCAN radio repeater and the PVC casing with which the radio repeater will be mounted onto a near-by lamp post.

Results of the ZONESCAN Alpha pilot installation

The pilot ran towards the end of 2012 for about 6 months with 40 measurement points (40 correlating noise loggers, plus respective repeaters and Alphas). Despite starting from a “clean slate” the results were very encouraging:

- From the first day, the data was transmitted successfully from the valve chambers to the servers
- Of the two previously identified and “repaired” leaks, two could immediately be re-identified; evidently one had never been fixed and the other one was badly repaired so that it started leaking again.
- With the 40 measurements points, covering ca. 10km of pipe network, the ZONESCAN Alpha system identified 10 leaks in 6 months, which were subsequently successfully confirmed and repaired.
- Mei Carmel invested ca. ILS 200,000 into the technology, and the savings just from water for the pilot period were estimated to exceed ILS 420,000 in the first three months (an article about this was published in the business journal Kolbo in November 2012).
- The size of the 10 identified leaks varied greatly, with the largest being 8 m³/hour (ca. 135 litres per minute)

Based on the experiences from the pilot, Mei Carmel decided to roll-out ZONESCAN Alpha onto its entire network of 580km water distribution pipes. A contract was signed to expand the installation through 2017 with an annual 300 measurement points, resulting in an eventual total size of at least 1,500 measurement points across Mei Carmel’s entire network.

Everything you need in one screen in the cloud

One thing about ZONESCAN Alpha that Mei Carmel appreciates every day is that its entire network can be displayed in one screen in GUTERMANN’s management software ZONESCAN Net. All data is transmitted

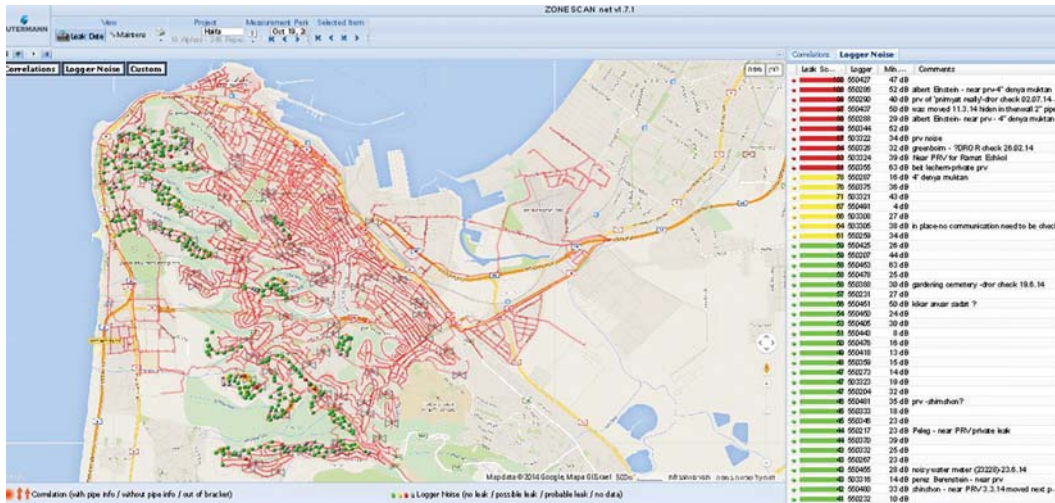

Figure 17.12.5 The ZONSCAN NET web screen with the area covered by ZONSCAN sensors and all data presented in a nice overview. (Source: Gutermann)

every night so that the ZONSCAN Net server can calculate all correlations and alarms within hours and show all existing and new leak indications in a very easy-to-analyse overview with attached Google Maps interface.

Accuracy of the system

Contrary to competing leak monitoring systems which fail to avoid false alarms caused by ambient noise, ZONSCAN Alpha is able eliminate non-leak noise sources automatically by (1) analyzing the frequency spectrum of the recorded noises and (2) providing enough data, time-synchronised between each logger pair to less than 1 millisecond, to allow for a correlation between the loggers, leading to a 30 times higher sensitivity than conventional noise loggers. Of course, the leak indications in GUTERMANN's cloud



Figure 17.12.6 Leak position indicated in ZONSCAN NET. (Source: Gutermann)



Figure 17.12.7 Leak position marked in blue by contractor. (Source: Gutermann)

software ZONESCAN NET, displayed on a Google Maps interface, depend entirely on the information about pipe length, diameter and pipe material put in by the water company and on any overlaying customer-specific GIS information imported into ZONESCAN NET. The fact, however, that you can narrow down your search to just a couple of meters is a winning argument for any leak operator. In the pictures below, you can see one example of where ZONESCAN Net showed the leak position, and where the contractor put his mark on the street.

Roll-Out of Phase 1 and immediate success

Over summer 2013 the fixed network leakage monitoring programme was devised and a 5-year deployment plan determined. Phase 1 (300 additional measurement points) would be delivered and installed in 14 of Haifa's residential neighborhoods in autumn 2013. The system went live in October 2013. Within the first six months of operation, Mei Carmel's leakage team around Reut Gotfrid identified and confirmed 57 leaks with Zonescan Alpha (see Figure 17.12.5) and 18 more by the end of June. With the exception of February, every month at least 8 leaks could be detected and verified. Overall, the number of leaks found equates to more than 1 leak per year per km of pipe network.

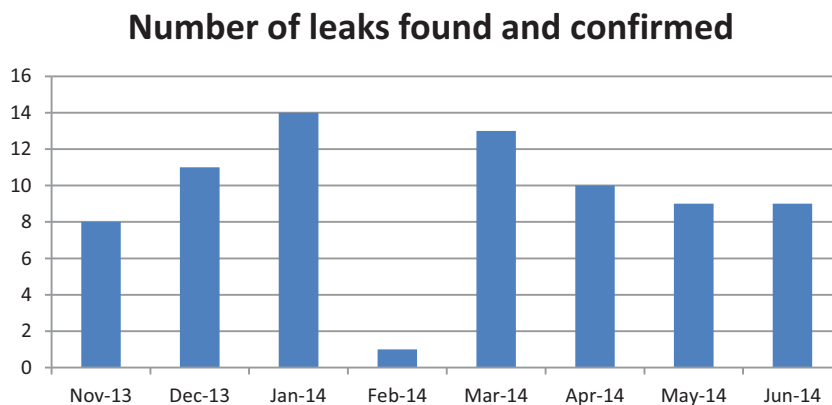

Figure 17.12.8 75 leaks found in 8 months with 350 sensors. (Source: Gutermann)

Total cumulative annual water loss reduced (ml)

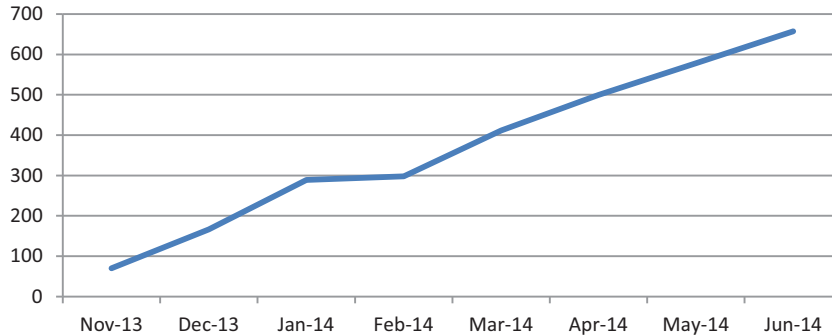

Figure 17.12.9 650,000 m³ annual leak run rate reduced after eight months. (Source: Gutermann)

Fast reduction in non-revenue water following the first eight months

Within eight months of using ZONESCAN Alpha with 340 measurement points Mei Carmel had reduced its annual water loss run rate by over 650 million litres. At a marginal cost rate of ILS 6 per m³ = 1,000 litres (ca. EUR 1.30 at that time), the total annual amount saved just in water costs would amount to ILS 3.9 million (or EUR 845,000). This, of course, is a multiple of what Mei Carmel initially paid for the purchase and installation of the 340 measurement points. The payback therefore was achieved in just a few months.

By the end of 2014, the tally of identified and repaired leaks grew to more than 100 leaks. It's fair to say, therefore, that by that point, Mei Carmel had saved an annual run rate of about 900 million litres of water, equaling **savings of over EUR 1 million per annum**.

What's more, the **NRW rate was reduced from 15.9% to 8% in just 8 months!** (January to October 2014). According to Stav Avraham, "all this could be achieved even after the company had used some of the leading leak detection contractors in the industry to sweep the network for running leaks.

The worst area in terms of leaks used to be the Bay Area, with an NRW rate of 57%. Thanks to Mei Carmel's proactive leakage management using ZONESCAN Alpha, that leakage rate was reduced to 12% in just 5 months (May to October 2013) by finding and fixing several large leaks that produced cumulated leakage of 5,000 m³ per day!

Continuing the ZONESCAN ALPHA expansion in Haifa

From the beginning it was planned that ZONESCAN ALPHA would eventually cover all (or all relevant) areas of the city. The expansion would happen in several steps:

- 350 measurement points in autumn 2014
- 400 measurement points in summer 2015
- 300 measurement points each in 2016 and 2017

Overall, the city will be monitored for leaks by 1,500–2,000 correlating loggers throughout the network.

Mei Carmel has started developing its own work flow programme to optimally work with ZONESCAN system and keep track of indicated leaks and subsequent work performed on those locations. At the same

time, Mei Carmel are building up infrastructure (pressure zones, DMAs) that will help the management better assess the size of occurring leaks by measuring daily minimum night flow figures, something that will allow the leakage teams to prioritise repair works according to the largest leaks.

Conclusions

This is a strong example of a successful NRW reduction programme using modern leak detection and monitoring technology. The biggest achievements are:

- Strategic focus on tackling water loss – top down capital expenditure decision and management attention during the implementation and the operation of the leak monitoring programme
- Less than EUR 300,000 invested in permanently installed leak monitoring technology – over EUR 1 million saved in reduced water losses
- Reduction of NRW rate from 15.8% to 8% over the course of less than one year
- Very high pinpointing accuracy of ZONSCAN ALPHA
- Leak reduction programme can go hand in hand with the implementation of customer-side metering, DMAs and active pressure management to achieve even greater results.

17.13 GUTERMANN ZONSCAN 820 ACOUSTIC NOISE LOGGING CASE STUDY – SOUTH EAST WATER

ZONSCAN 820 LOGGERS HELP SOUTH EAST WATER INCREASE LEAK PINPOINTING BY 54%

Gutermann Ltd, First Floor, Business Unit A, Deacons House, Bridge Road, Southampton SO31 8AZ, UK, Tel: +44 (0)2380 408 830, Fax: +44 (0)2380 408 831, www.gutermann.eu

Introduction

After initial meetings about suspected hidden leakage with Gary Ford and Robert Anthony, a trial was carried out with ZONSCAN 820 lift and shift Acoustic Noise loggers. Following a successful trial, South East Water bought 400 correlating loggers designed specifically for town centres and 700 of the most up-to-date lift and shift noise logger for elsewhere, placing them underground onto their pipes to monitor the sound-of the water passing through the network.

Challenge

The company's war on leaks lead an internal target to reduce leakage to 85MLD by 2018, this meant looking beyond traditional methods and going into DMAs that hadn't been surveyed in years.

Solution

When the streets above are quiet between 2am and 4am, the correlating loggers come alive and listen to any sound coming from the pipes and transmit data back to the office for analysis. Any leaks can now be easily heard by the leak busting team who set about repairing them before they cause major problems to the network.

These new more sensitive and accurate correlating loggers have replaced basic ones used for many years which have only given the leak information in numerical form.

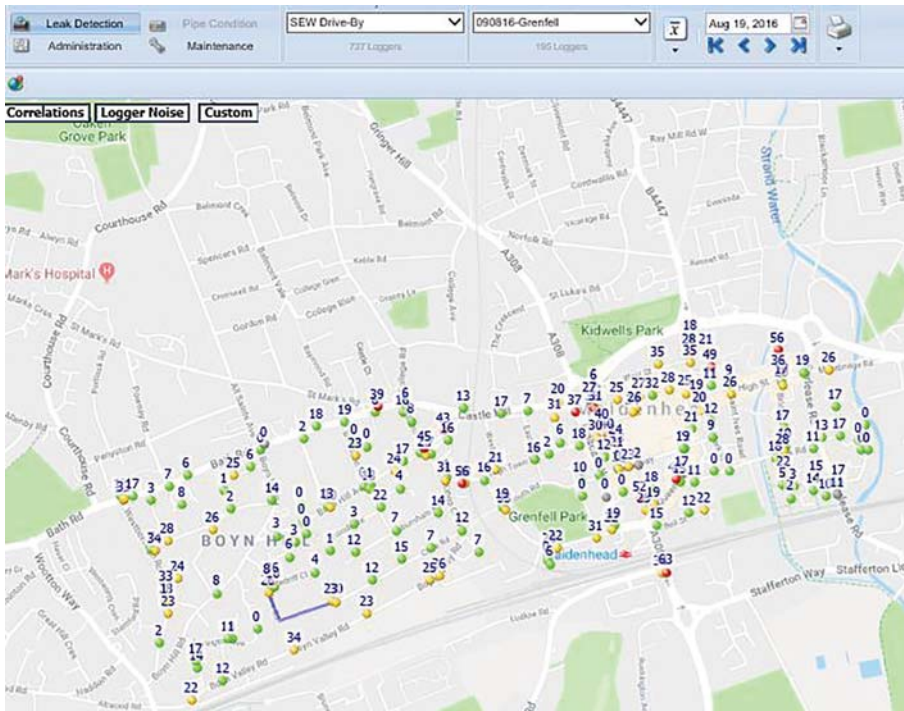

Figure 17.13.1 Noise logger deployment. (Source: Gutermann)

Robert Anthony, Leakage Detection Manager for Hampshire, Berkshire and Surrey said: “We care about finding and fixing leaks as quickly as possible, but with most hidden underground and out of sight we need to use specialist technology like these correlators and loggers to track them down before we can repair the pipe”.



Figure 17.13.2 Deploying a noise logger. (Source: Gutermann)

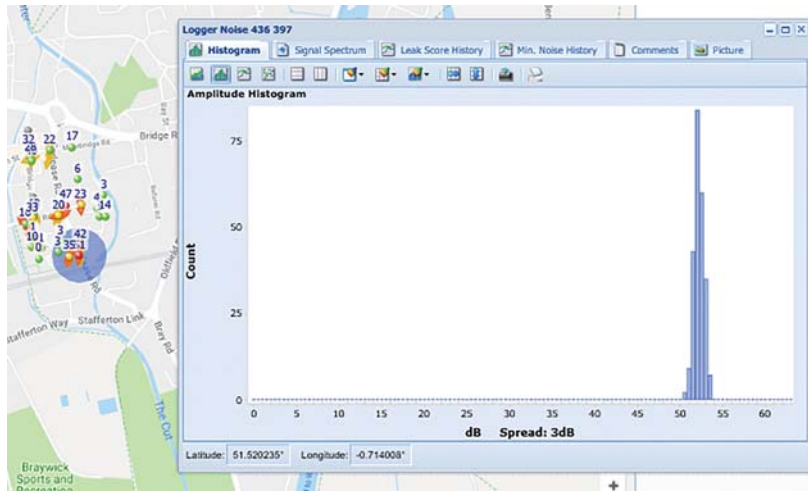

Figure 17.13.3 Leak identified on software. (Source: Gutermann)

Nine lift and shift logging technicians were recruited, six of which were based across Kent and Sussex and three covered Hampshire, Berkshire and Surrey. Each technician was given 80 loggers whereby they would be going into DMAs of high leakage or unknown leakage.

400 Noise Correlating loggers were placed in town centres across Kent and Sussex whereby it is hard to detect leakage during the day.

The coverage from the 1100 loggers allowed South East Water to better their coverage across the network.

Results

Gary Ford, Kent and Sussex's Leakage Detection Manager said: "These new loggers have enabled us to repair small leaks, before the holes in the pipe had a chance to grow losing more water and possibly causing the water to seep to the surface of the ground. This new equipment is helping us go that little bit further to providing the five out of five service our customers expect".

With a £133,000 investment in new leak detection technology it has seen the number of leaks found by the company has increased by 54% in just 3 months.

The coverage that South East Water has of their DMAs has increased by 0.8 to 2.4 allowing the company to have a better understanding of DMAs with unknown or high leakage.

17.14 PARK CITY, UTAH

Mountain resort city reduces water loss by 10 percent by deploying intelligent leak detection and pressure monitoring solution

Introduction

Long before Park City, Utah became a world-class mountain resort and venue for the 2002 Olympic Winter Games, it was famous as a silver mining town. Founded by prospectors in the late 1800s, Park City

Consolidated Mines continued to mine silver until the early 1970s, at which time the company brought the ski business to the small town of 8,000. Over time, when combined with summer tourism and the Sundance Film Festival, this shift away from mining has attracted more than 600,000 annual visitors.

While Park City Municipal Corporation set a goal for Park City to become the “The Best Resort Town in America,” its relatively small Public Utilities Department is also gaining accolades for its forward-thinking approach to leak detection and to addressing water loss in a city which receives about half as much rainfall as the national average. The town chiefly relies on melting snow to recharge the ground water system, and the next viable source is much more expensive. Additionally, rapid residential and commercial developments near Park City are placing increased demands on ground water resources and as the population swells, more expensive water sources will have to be pursued.

Challenge

Jason Christensen serves as Water Resources Manager for Park City, which has more than 120 miles of pipe in its distribution network. Many of the pipes are more than 60 years old and are covered in mineral soil that is corrosive in nature. By reviewing SCADA and Sensus AMI consumption data, as well as results from a previous leak detection survey, Christensen was aware of leaks in their system that attributed to a loss of 100 GPM.

Park City engaged Xylem to deploy their intelligent sensor hardware and monitoring solutions as part of a condition assessment program to understand their system and reduce non-revenue water. The project involved monitoring six pressure zones and reporting on anomalies such as leaks and bursts and identifying assets that are likely to fail through predictive analytics.

Programme highlights

- 20 stations capable of measuring pressure and acoustics deployed
- During a five-month period, seven leaks identified over nearly 13 miles of pipe



Figure 17.14.1 Park City, Utah. (Source: Xylem)

- Transient monitoring revealed harmful pressure spikes generated by a soon-to-be-retired pump station
- Program costs expected to be repaid in under three years from water savings alone

Services provided:

- Acoustic leak monitoring
- Transient pressure monitoring

Pipe material: Steel (transmission main) Ductile Iron & PVC (distribution mains) HDPE (service lines)

Diameter: 1 in to 12 in (25 mm to 300 mm)

Transmission type: Water

Solution

Acoustic and transient pressure monitoring sensors were installed at 20 sites. For more than five months the sensors were used to monitor for leaks and understand the operational pressures and surges within the network, and their impact on the structural integrity of the pipelines.

Xylem's advanced sensing platform uses acoustic, pressure, and flow data integrated with advanced analytics to detect leaks and bursts on critical network sections. The solution combines the analytics from three major leak detection methodologies – pressure transients, hydrophones and flow rates – to help utilities reduce non-revenue water. This automated process, supervised by analysts in a 24/7 monitoring environment, simplifies the visualization of data and helps repair crews prioritize their response.

Xylem's transient pressure monitoring is a non-invasive and cost-effective way to monitor water networks for the presence of damaging pressure surges. Through its in-line detection of pressure transients, the solution helps determine the source of these events and identifies pipes under stress with high likelihood of leakage. This early warning helps manage damaging pressure variations and mitigate the risks associated with premature pipe failure, prolonging the effective life of infrastructure assets.

Outcome

Through a previous leak detection survey, Park City identified leaks that represented a loss of about 100 gallons per minute. By deploying the Xylem solution, the City identified an additional seven leaks, bringing total non-revenue water loss to 300 gallons per minute, representing 10 percent of demand.

“We're seeing a lot of benefit to focusing on these leaks now and seeing what we can do to find the leaks that aren't surfacing. We've reduced our operating costs by about \$50,000 – that's a real savings that pays for the service and repairs...money we're saving the community.”

Jason Christensen, Water Resources Manager, Park City

The leaks cost the city nearly \$55,000 in costs to repair, not including the value of water lost. Findings from the transient monitoring revealed harmful pressure spikes generated by a soon-to-be-retired pump station. Future recommendations involve another round of monitoring after the pump station is retired to ensure the changes had a calming effect.

Going forward, the city now has a better handle on the condition of its system, and will further monitor their system for new areas of concern.

By actively listening to the system 24/7 and analyzing the real-time data to find leaks, the City found an additional loss of 200 gallons per minute.

Findings from the transient monitoring revealed harmful pressure spikes generated by a soon-to-be-retired pump station.



Figure 17.14.2 Excavated leak (Source: Xylem)



Figure 17.14.3 A longitudinal split on one of the seven leaking HDPE service lines that were buried deep below the surface. (Source: Xylem)

17.15 TRUNK MAIN CORRELATION

Gutermann case study 18" main

Introduction

Locating leaks on large diameter water mains can be very difficult due to poor sound propagation and increased distances between fittings that can be used to perform correlations from. For a correlator to highlight a potential leak each sensor must be able to receive the signal from that leak. Once a correlation is highlighted it is then down to the software and the user of the software to accurately pin point the potential leak as the noise created by the leak may not be heard from the surface due to its depth.

The accuracy of the correlation is important as repairing a large diameter water main can be expensive as they are typically deeper than smaller diameter water mains so excavations are larger. They may also run through the centre of busy roads which mean additional traffic management measures need to be in place.

There is also the potential disruption to supply. If the water main has to be isolated to carry out the leak repair it may affect customers downstream meaning they will be without water until the repair has been completed.

Scope of work

A client had a known leak on an 18' cast iron water main as water was showing on the surface. The location of the surface water was in the middle of a very busy road downhill from a roundabout. The road had to be closed before repairing the leak, this meant costly traffic diversions had to be put in place.

Correlations were required to accurately pin point the leak location to limit the size of the excavation needed to repair the leak.

Correlation survey

The correlation survey was performed using the Gutermann Trunk Main correlator with the standard sensor configuration.

Correlations took place in the evening due to the busyness of the road and the location of the valves to be used.

Correlations were conducted 502m upstream and 826m downstream from where the surface water was showing to determine the correct location of the leak.

A minimum of two correlations were performed for each valve pairing to show consistency between the correlations giving confidence in the correct location of the leak.

Upstream correlation

Point of interest on sensor 'B' located on the valve on the entrance to the roundabout (location of surface water). This correlation showed the leak location to be beyond sensor 'B' (out of bracket).

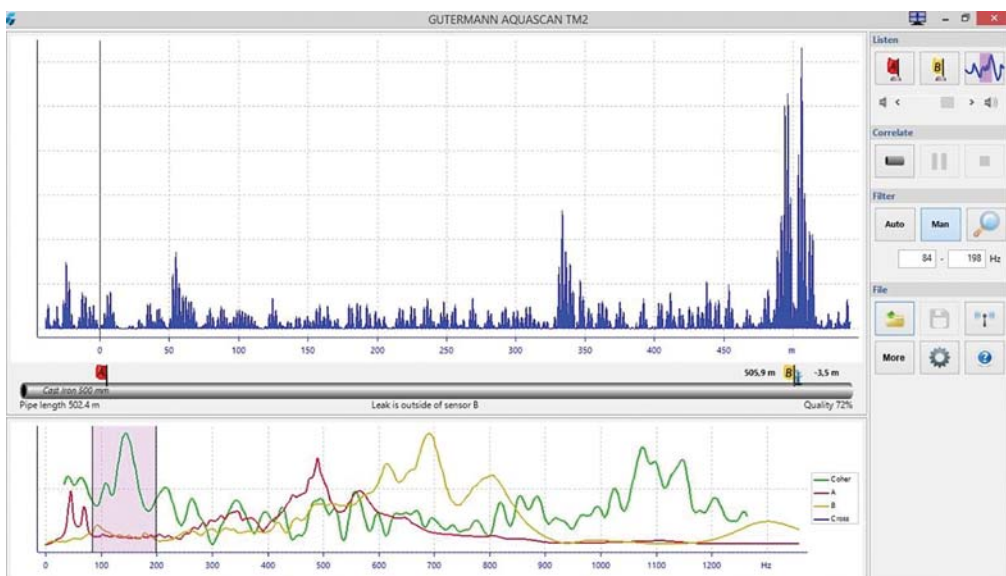

Figure 17.15.1 Correlator screen shot with area of interest. (Source: Gutermann)

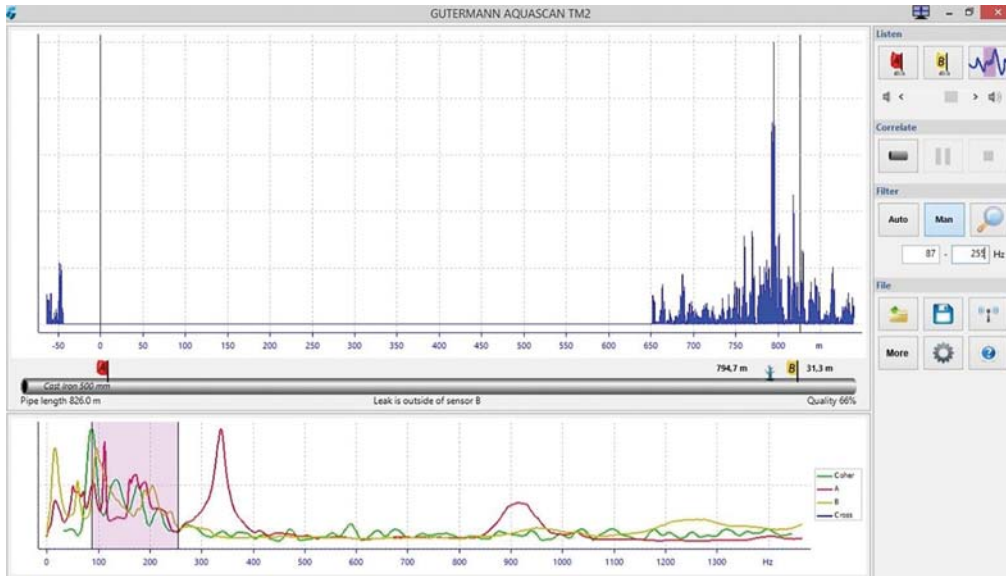

Figure 17.15.2 Correlation screen shot. (Source: Gutermann)

Downstream correlation

Sensor 'A' was then moved to the next available valve 826m downstream of the surface water with a point of interest gained 31.3m from sensor 'B' located on the valve on the roundabout.

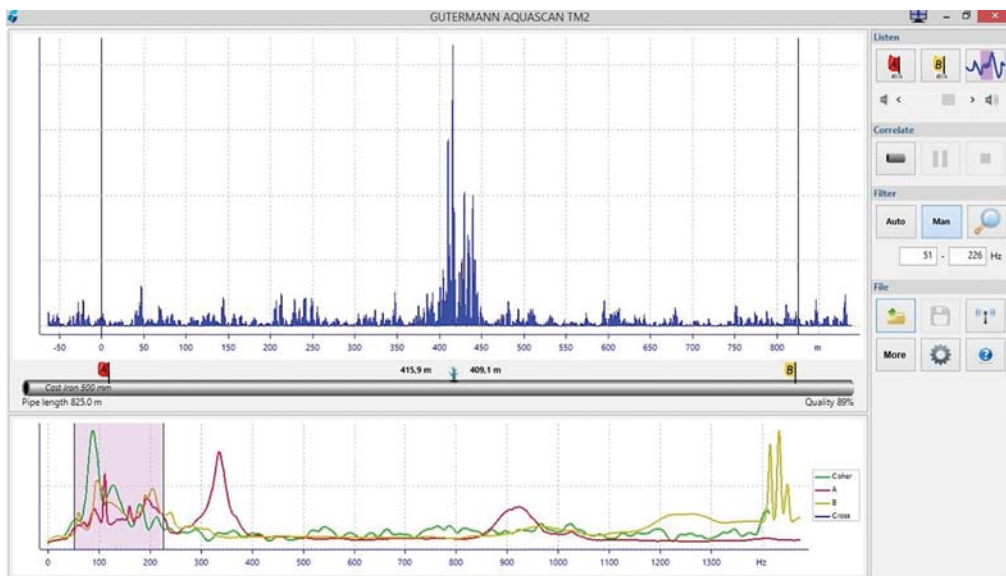

Figure 17.15.3 Correlator screen shot. (Source: Gutermann)

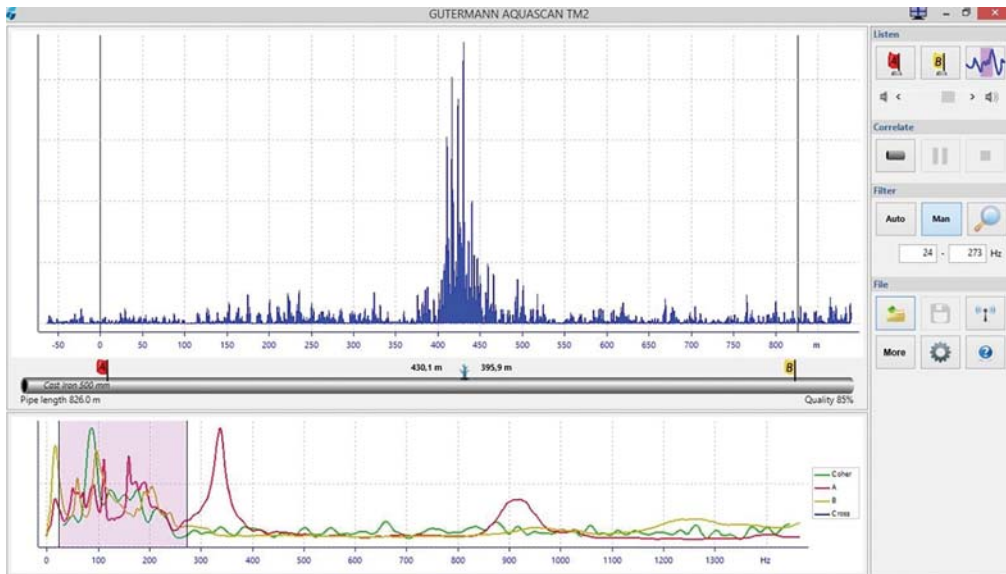

Figure 17.15.4 Correlator screen shot. (Source: Gutermann)

Note: Peak suppression was used to gain point of interest 31.3m from sensor 'B'.

This correlation gave confidence to proceed with the planned repair of the water main.

During the downstream correlation two additional points of interest were gained at 415.9m and 430.1m from sensor 'A'.

These additional points of interest were followed up and it was found that these were both unknown leaks 15m apart on either side of a bridge crossing a river.

Summary

Three water leaks were located over a distance of 826m using the Gutermann Trunk Main correlator in standard configuration, one known leak and two additional unknown leaks. Locating the known leak gave the client confidence that the leak would be repaired within a scheduled time during the road closure.

The two additional unknown leaks were located on joints where the water main followed the contour of the bridge.

17.16 AQUASCAN TM2 WITH HYDROPHONES

Gutermann/Yorkshire Water

Introduction

Yorkshire Water had previously used different leak detection methods and traditional correlators to find large diameter main leak detection. Results of these methods were to be compared with those using a specialist trunk main correlator, in this case Gutermann's AQUASCAN TM2. As initial location for this study an 18' Cast Iron trunk main was identified from Longwood Service Reservoir feeding four large DMAs.

Challenge

The cast iron main had several hydrants where hydrophones could be used at approximately 900 m distance between them. The area is built up with a mixture of domestic and industrial properties as well as several large trees along the route of the proposed study.

Solution

The AQUASCAN TM2 using hydrophones was set up using aerial extensions to avoid signal loss over the 900 m distance which can be caused by tall buildings and large trees between the sensors. The pipe information was input into the AQUASCAN TM2 and a correlation run. It took approximately 5 minutes for correlation peak to develop at 520 m with a quality of 100%. The distance was measured out to find a supply feeding a mill running with the meter not registering the flow. Other points of interest were identified using peak suppression on this length of main.

Conclusion

Yorkshire Water carried out several successful correlations on the Longwood trunk main using the specialist large diameter main correlator with hydrophones from Gutermann. The repairs of the identified leaks led to savings on this main of around 900 m³. Yorkshire Water have since formed several trunk main leak detection teams equipped with such trunk main correlator kits.



Figure 17.16.1 Gutermann large diameter mains correlator AQUASCAN TM2 with hydrophones and aerial extensions. (Source: Gutermann)

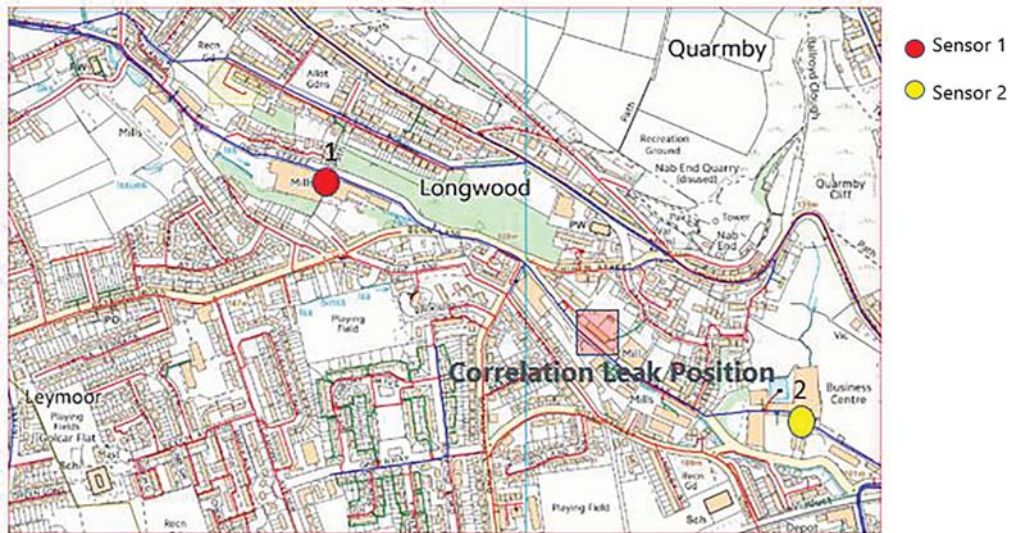

Figure 17.16.2 Sensor deployment for correlation. (Source: Gutermann)

Detailed Results

Correlation 1: Longwood CT29 – 18" CI

Longwood CT29 – 18" Cast Iron. Correlation 1-2 (900 m, 18" main CI). Peak 520 m from point.

A good noise was found on the supply (possibly missing consumption estimation of 300 m³/d). This had not been picked up on previous leak detection exercises.

18" Main CI – Under Investigation.

ICA job raised to check customer meter

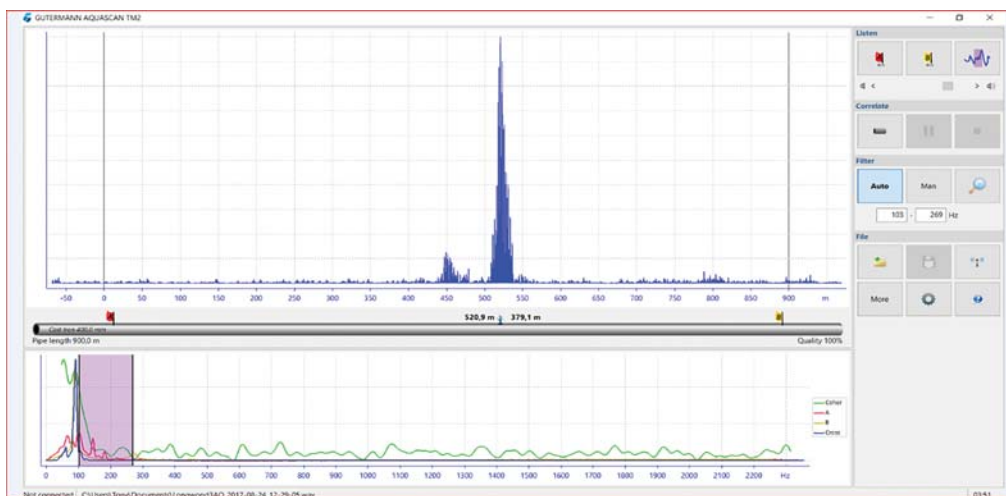

Figure 17.16.3 Correlator screen shot. (Source: Gutermann)

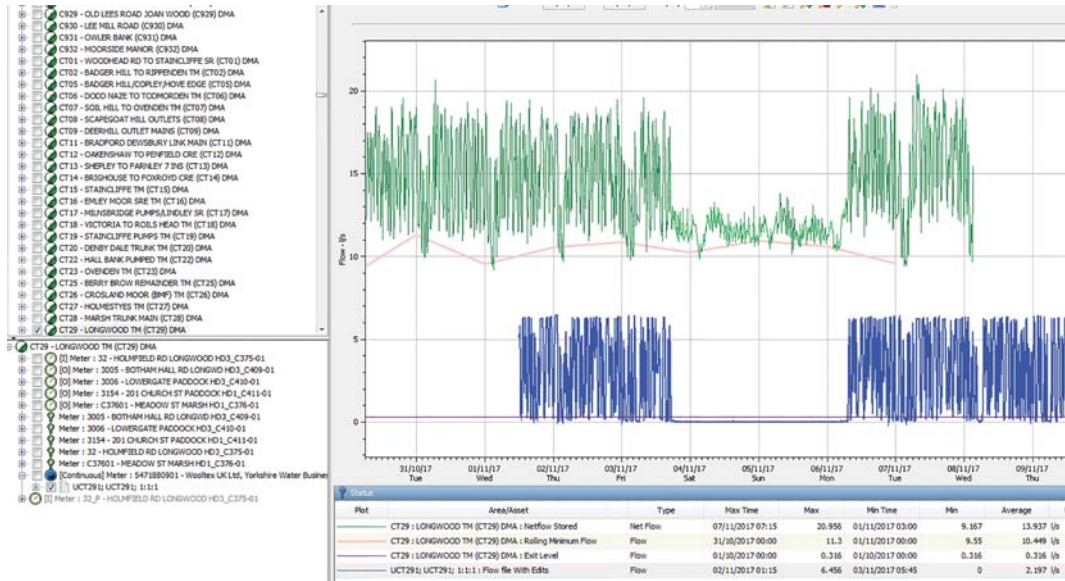

Figure 17.16.4 CT29 Flow Profile, Missing Consumption (Longwood) 2.197l/s (254m³/d). (Source: Gutermann)

Correlation 2 –: BT22 Shipley – 125mm MDPE

BT22 Shipley – MDPE main 125 mm, 68.7 m correlation. Step test shows 2l/s drop

Correlation 3: John Street Thornton, 420 m correlation on Mixed Material

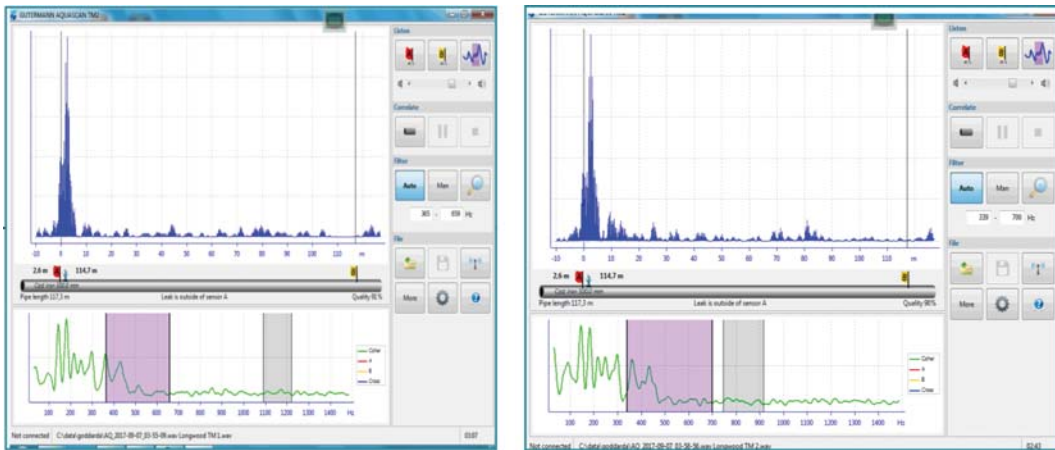

Figure 17.16.5 Correlator screen shot. (Source: Gutermann)

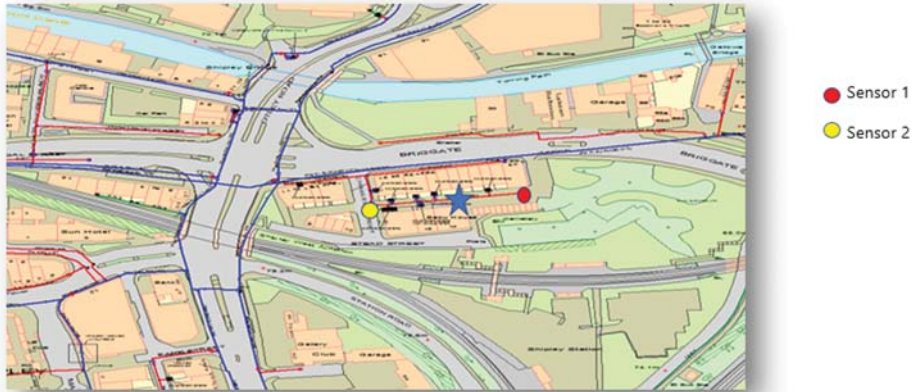

Figure 17.16.6 Sensor deployment for correlation. (Source: Gutermann)

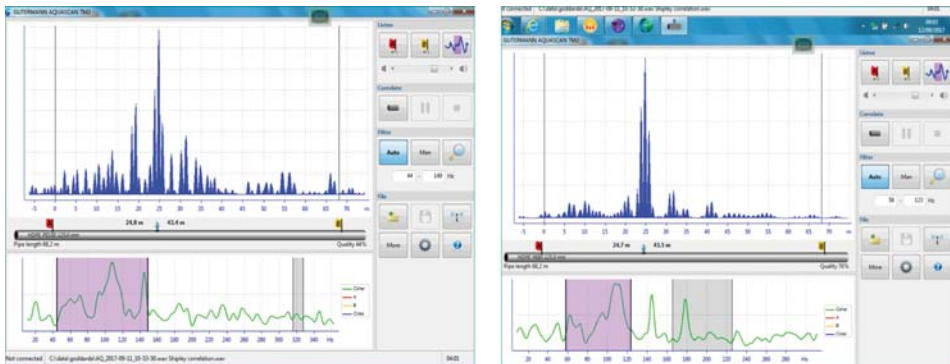

Figure 17.16.7 Correlator screen shot. (Source: Gutermann)

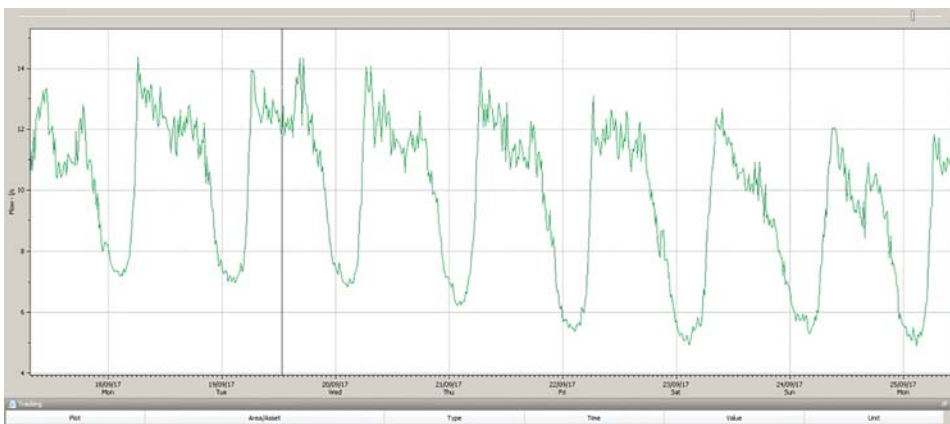

Figure 17.16.8 BT22 Shipley 2 l/sec drop (Source: Gutermann)

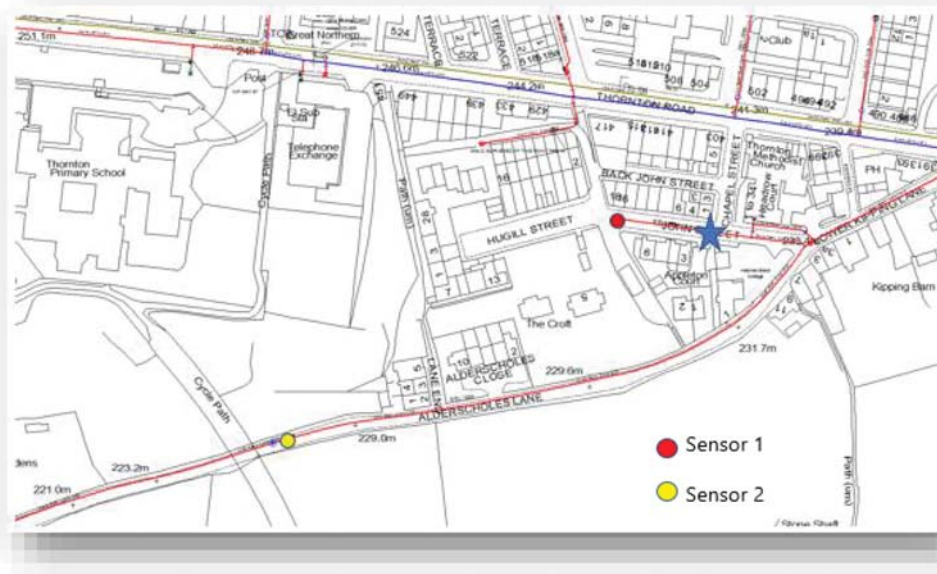

Figure 17.16.9 Sensor deployment for correlation. (Source: Gutermann)



Figure 17.16.10 Corelator screen shot. (Source: Gutermann)

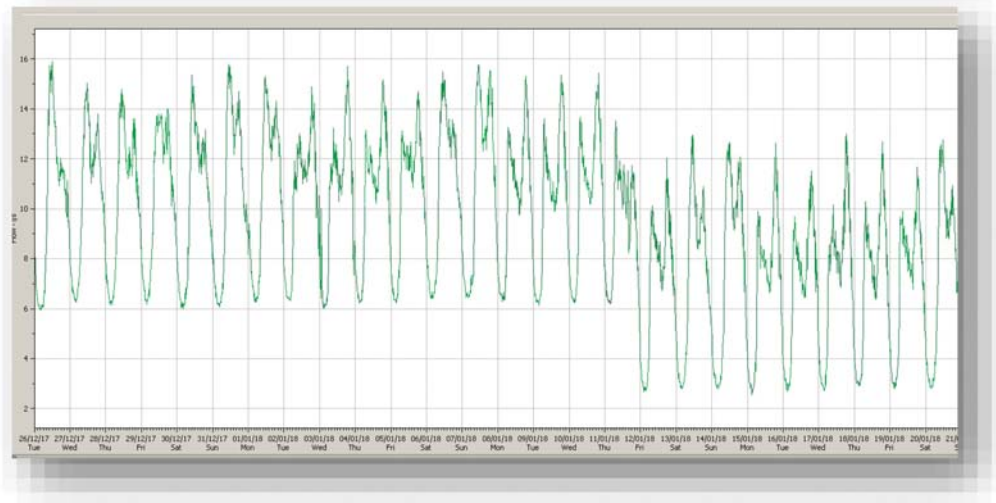

Figure 17.16.11 DMA nightline reduction after leak repair. (Source: Gutermann)

17.17 UNITED UTILITIES – ADVANCED TRUNK MAIN LEAK LOCATION

Ian Greenwell, Regional Sales Manager, Primayer

Introduction

Leak detection on trunk mains using correlation techniques has always had potentially limited success for reasons of poor sound propagation and scarcity of accessible fittings. With Primayer Enigma-hyQ digital noise correlation and signal coherence frequency analysis processing these previous limitations have been far exceeded.

Trial details

During July 2013 controlled tests were carried out by Ian Greenwell, Andrew Mackenzie (of Primayer) and Paul Cunliffe, Shaun Graham (of United Utilities) on a 500 mm diameter PVC trunk main within the Winscales and Scilly Banks service reservoir zones (Figure 17.17.1). Local United Utilities NCI/NIA had previously split the main and quantified losses of 4 litres/sec and 2 litres/sec in the respective halves.

Scilly Bank

The Enigma-hyQ loggers were programmed to record three sound epochs to separate genuine water usage from constant leakage. The loggers were deployed during working hours at multiple access points along the main.

Shown (Figure 17.17.2) is the schematic of the five Enigma-hyQ loggers positioned on the main over a total distance of 3527.7 m. These schematics interface with Google Maps and are a feature in the software allowing users to easily lay out pipe networks. The schematic gives easy visualisation of logger positions



Figure 17.17.1 Enigma-hyQ logger installed on 500 mm PVC main via fire hydrant. (Source: Primayer)

and correlations requiring investigation; it also allows clicking on any Enigma-hyQ logger to hear the noise recorded.

Results

As shown (Figure 17.17.3) indicates what was found on the main after deployment, read back and post analysis processing of the data. A leak was indicated between loggers OB2 and OB3 over a distance of 876 m. The leak was located at 357.9 m from logger OB2.

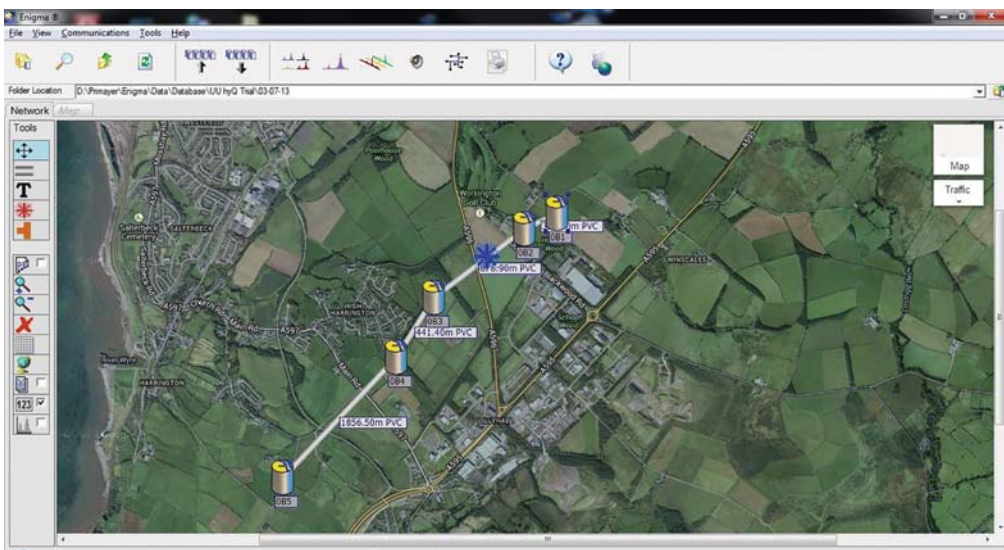

Figure 17.17.2 Schematic of Enigma-hyQ logger positions, total distance 3527.7 m. (Source: Primayer)

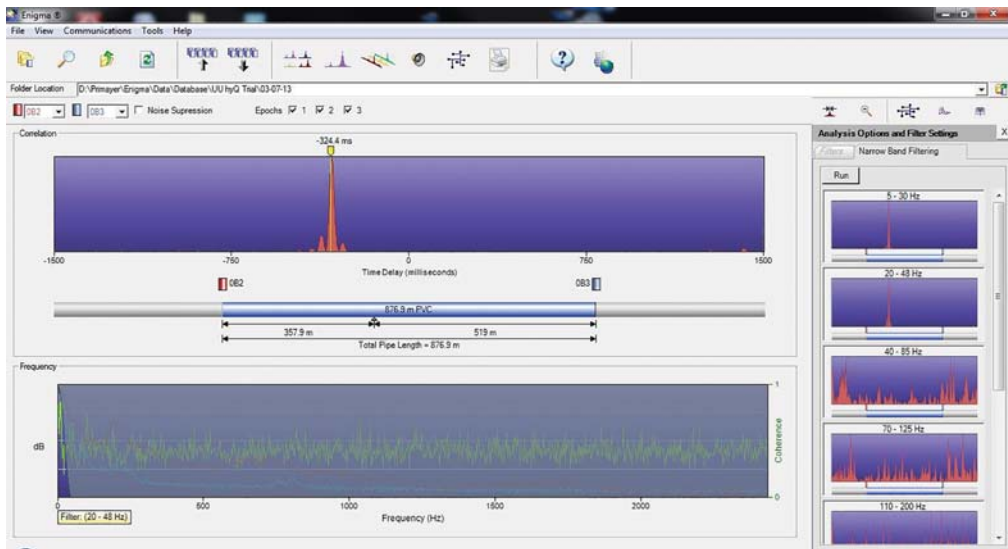

Figure 17.17.3 Logger screen shot. (Source: Primayer)

Follow up

Shortly after the position was highlighted by the Enigma-hyQ the area was excavated and the leak located (Figure 17.17.4). It was later verified as a 4 litres/sec leak. This equates to wastage of 345,600 litres every 24 hours, costing £528.76 per day.

Paul Cunliffe, Regional Leakage Team Leader, United Utilities, Manchester, quoted “Absolutely magic result, Shaun and I did say on the day of the trial that if there is a leak where indicated we would be very impressed. What can I say!!!! Bang on and over that distance, really impressed. It’s the only kit that I have seen work on plastic, not to mention the distance. All the hard work on the day has proved dividends.”



Figure 17.17.4 Detected leak. (Source: Primayer)

17.18 RANHILL SAJ, JOHOR, MALAYSIA – MEETING THE CHALLENGE FOR REMOTE LEAK PINPOINTING

YS Chan, General manager, Primayer, Malaysia

Introduction

Ranhill SAJ Sdn Bhd, a subsidiary of Ranhill Holdings Berhad, is an integrated water supply company involved in the process of water treatment and distribution of treated water to consumers right up to billing and collection. It serves around 3.1 million population and manages 22,175 km of pipes over an area of approximately 19,000 km.²



The challenge

The current NRW of Johor, as at December 2018, is 24%. In achieving NRW of 5% by 2025, several activities have been done. One of the activities implemented to achieve the target is by creating SMART DMA's. In the initial stage five DMA's involved in implementing the SMART DMA program. Enigma3m were deployed at a DMA for at least three months where first month is to find leaks from the correlations obtained, second month to repair leaks and third month will be for monitoring purposes (Figures 17.18.1 and 17.18.2).



Enigma3m (Source: Primayer)

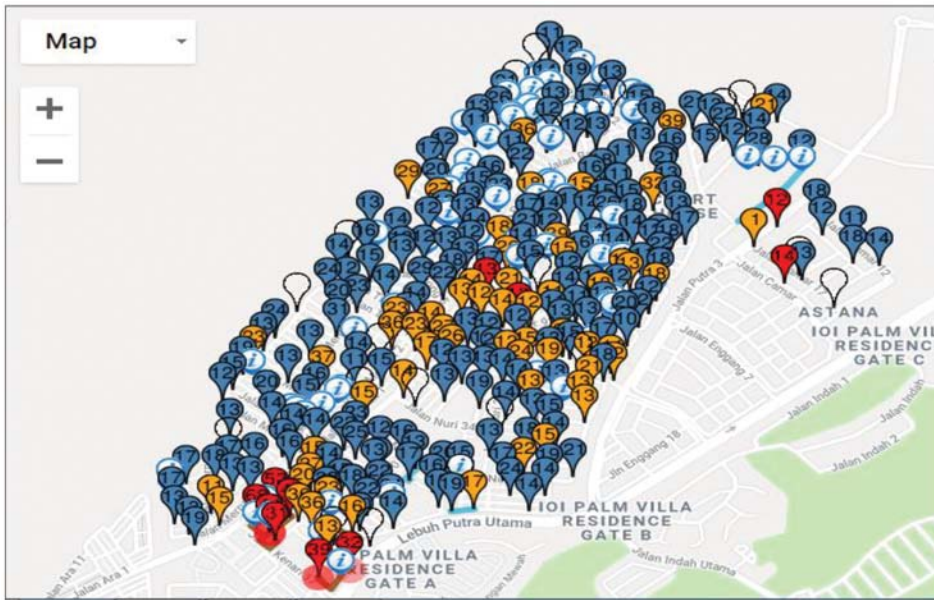

Figure 17.18.1 Locations of Enigma3m across DMA. (Source: Primayer)

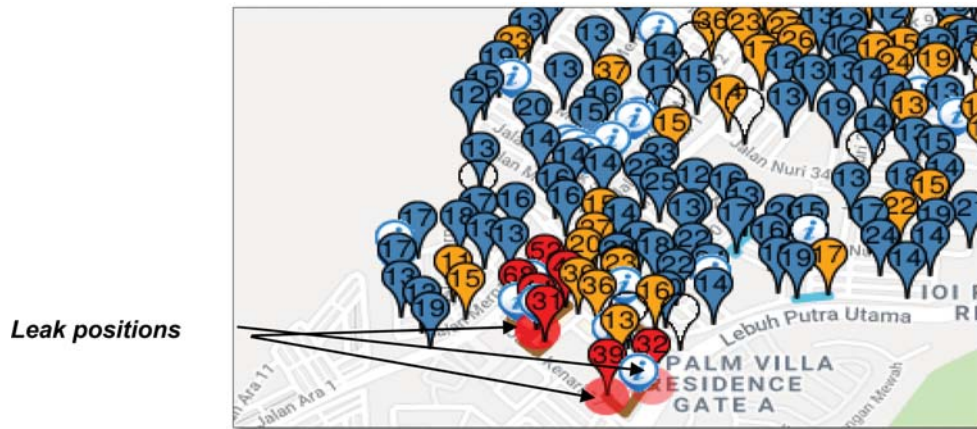

Figure 17.18.2 Leak pinpointing. (Source: Primayer)

Trial at Bandar Putra, Johor Bahru, Johor

Total pipeline length to be covered for the Bandar Putra B, DMA, is 38.51 km with 5052 connections. The Net Night Flow (determined by subtracting Legitimate Night Flow from the Minimum Night Flow) before installation of Enigma3m was at 30.99 l/s and total daily flowrate was 6200 m³/day. During the implementation of SMART DMA, a total of 295 units Enigma3m were installed. Pipeline material and distance of Enigma3m varies depending on pipe material from metal pipe to poly pipe. A total of 115 leaks were found and repaired in the second month of Enigma3m installation (Figure 17.18.3).

Net Night Flow reduction

Further to the results obtained from Enigma3m installation at Bandar Putra, the test was also successful as small leakages at hydrant valves and communication pipes were also able to be located. Overall, the NNF after three months of Enigma3m installation were reduced to 20.08 l/s from 30.99 l/s. This reduction gives a saving of 705 m³/day with a total cost of RM16,920/month (approximately US\$4000/month).



Figure 17.18.3 Excavations and leaks. (Source: Primayer)

17.19 AFFINITY WATER CHANGING THE ECONOMICS OF LEAK DETECTION WITH PERMANET+

Mike Tennant – HALMA WATER

Affinity Water, Britain's largest water-only utility serving 3.6 million people in southeast England, has partnered with HWM to target significant reduction in leakage rates using PermaNET+ fixed network telemetry.

"Using the HWM PermaNET+ solution, we can continuously monitor 25 per cent of our network, identifying leaks in a matter of hours, rather than the days it takes using conventional techniques and technologies," said Drew Ritchie, managing director of wholesale operations at Affinity Water.

Affinity already uses HWM datalogging technology to monitor its network's performance, but the addition of PermaNET+ will significantly enhance leak detection across the network.

PermaNET+ represents the next stage in the development of noise logging. Data generated by the noise logger is automatically sent to the user, removing the need to visit sites to carry out data collection. Data transmission is achieved through a combination of GPRS cellular communication or SMS. The unit also sends an audio file for remote monitoring and correlation to localise the leak position. PermaNET+ is located entirely below ground, making it less intrusive and more practical for large-scale deployment.

These features are critical to the long-term leakage reduction plan of Affinity Water, which has set ambitious targets for improvement of its network. "Of all the UK water companies, at Affinity Water we've set ourselves the largest percentage leakage reduction over the current five-year [AMP6] planning period," explained Drew. "We're achieving this with HWM's PermaNET+, challenging industry thinking and methodologies to change the economics of finding leaks."

By permanently monitoring water network infrastructure without extensive site visits, PermaNET+ identifies leaks more quickly than traditional methods and allows for rapid deployment to fix any leaks that do occur. This significantly reduces both water loss and the cost of identifying leaks within a water network.

The programme was completed in May 2017, with the installation of 20,000 PermaNET+ systems. This represents a long-term commitment to improved leakage reduction from Affinity Water, as Drew explained: "We're looking forward to working with HWM over the next 10 years to enhance the system and use leakage information in new and innovative ways. Our customers deserve the best. Together, we will meet the challenges defined in our business plan."



17.20 SCOTTISH WATER ADOPTS ACOUSTIC NOISE LOGGING

Ian Greenwell, Regional Sales Manager, Primayer

The recent advances in the new technology of acoustic noise logging and the operational benefits it can bring have been recognised by Scottish Water, as they look carefully at how this new technology can be deployed to further reduce leakage levels.

Scottish Water, at Glasgow, decided upon the use of Phocus3 noise loggers to further reduce their leakage – aiming to employ the latest techniques which improve the effectiveness and efficiency of leak location.



Figure 17.20.1 Phocus3. (Source: Primayer)

Phocus3 is produced by Primayer, one of the UK's top hi-tech manufacturers of data monitoring and leak location systems, who are recognised for their innovative approach to new aqua technology and design.

In principle, acoustic noise is recorded at one-second intervals over three hourly periods during the night, when background noise is likely to be lower. Noise amplitude (or loudness) will vary due to random effects, but there will always be a consistent minimum due to any noise that is always present – for example leakage. Furthermore, leak noise tends to have reasonably consistent amplitude.

Scottish technicians in the field 'lifted and shifted' the Phocus3 (Figure 17.20.1) and uploaded the recorded data on a daily basis to the newly developed PrimeWeb online platform. PrimeWeb was reviewed by an analyst who then pinpointed areas of interest for further investigation. These areas were followed up and confirmed with the use of the Enigma correlating noise loggers.

Crompton DMA – Map view

A large number of loggers were deployed on the network, with three main areas of interest highlighted (Figure 17.20.2). This later proved to be three leaks, one on a 4" cast iron main, which was proved and confirmed by Enigma, see Figure 17.20.3, the second leak was a passing hydrant highlighted LCF4 on Fairfax Ave and the third was a leak on a 6" CI Main on Aikenhead Road.

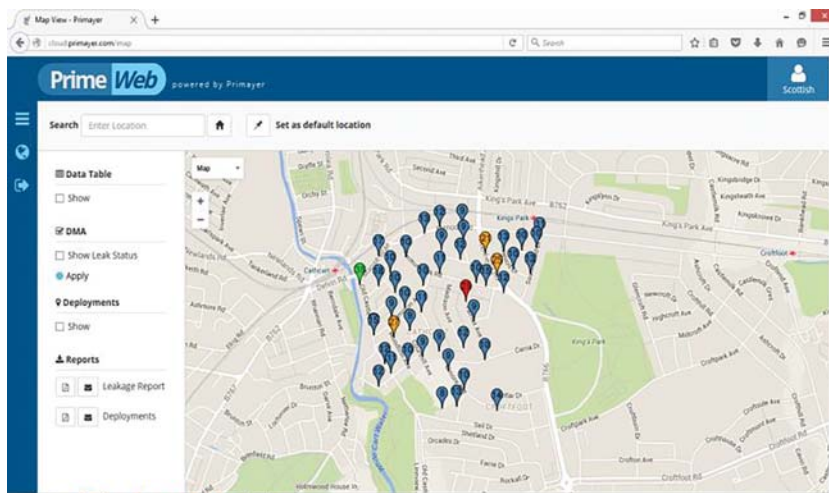

Figure 17.20.2 Map view. (Source: PrimeWeb)

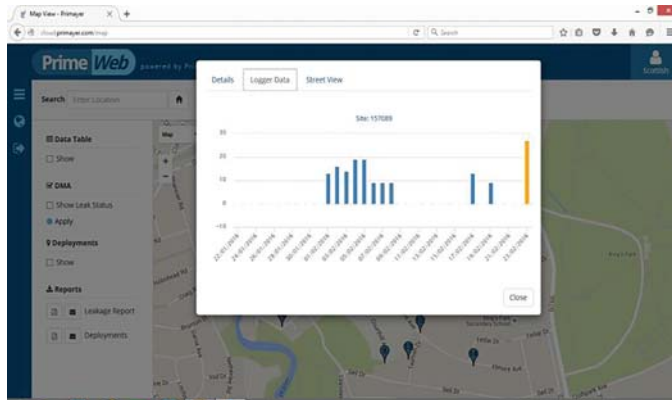

Figure 17.20.3 Data view. (Source: PrimeWeb)

Crompton DMA – Logger Data view

From the initial results closer investigation proves one of the areas of interest, showed a good leakage confidence factor – level 3, and critical noise value of 27.

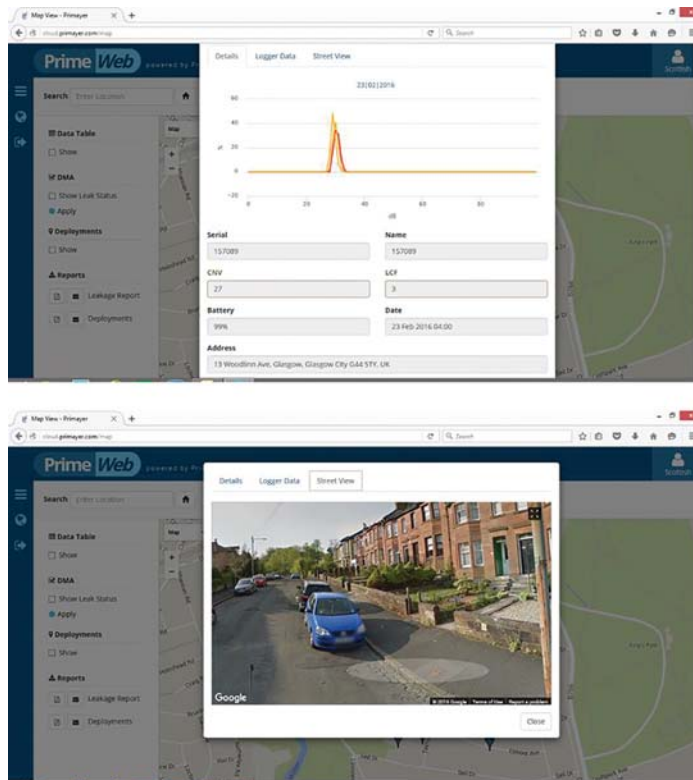

Figure 17.20.4 Histogram and street view. (Source: PrimeWeb)

Logger histogram

On further interrogation of this individual logger, results indicated the potential leak.

Street view

Within the PrimeWeb software, the exact GPS location of the logger deployment can be seen clearly on Google Street View, minimising the risk for error (Figure 17.20.4).

Enigma test report

The technician followed up the results indicated by Phocus3, the same day using the Enigma correlating noise loggers to pinpoint the location of the leak. The test report below shows the leak was pinpointed over 169 m of 4" cast iron main, on Woodlin Avenue, 117 m from a corresponding logger (Figure 17.20.5).

Results

Information received from Scottish Water show the overnight deployment highlighted three leaks, these three leaks equate to around 3 litres per second saving, and you can see the rise and the gradual

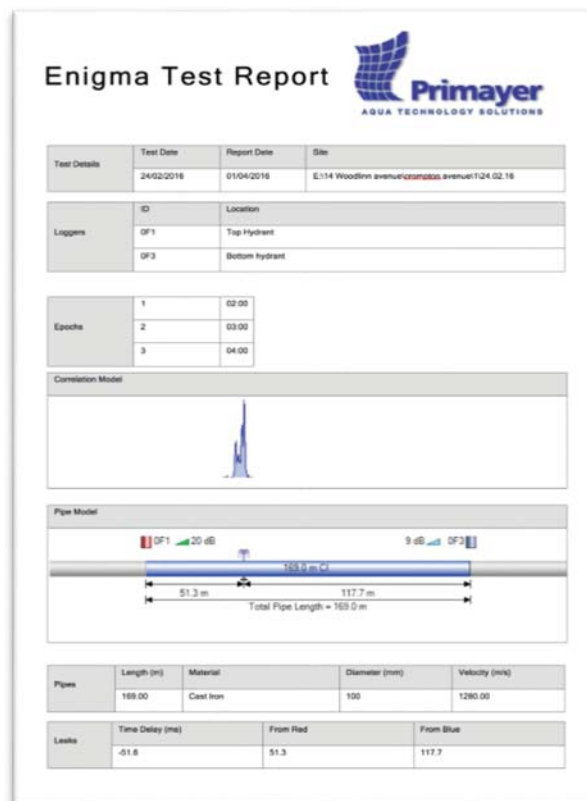

Figure 17.20.5 Test report. (Source: Primayer)

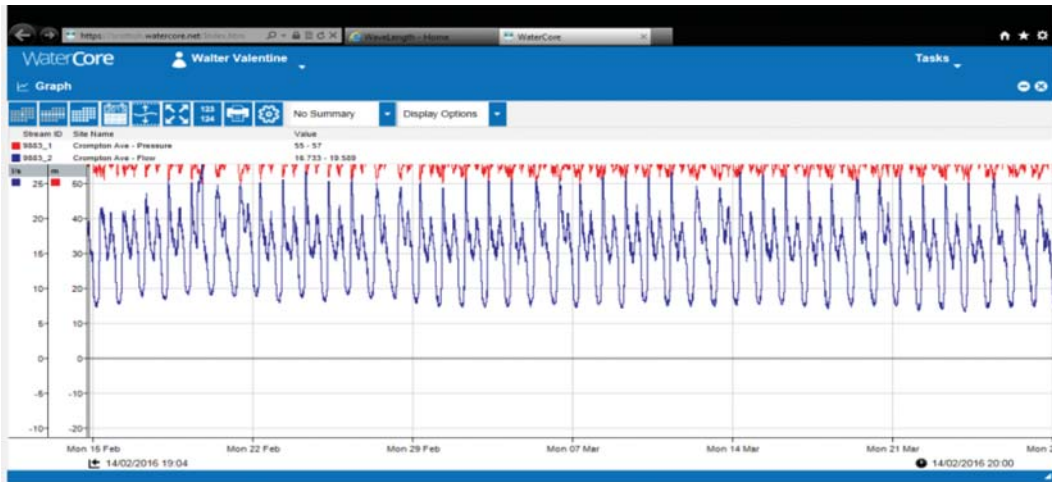

Figure 17.20.6 Acoustic trace. (Source: Primayer; Scottish Water)

reduction in flows within the DMA. There were two leaks repaired and a hydrant shut down on site as part of the investigations into the sweep (Figure 17.20.6).

Scottish Water continued to use this lift and shift methodology of localising the leak using Phocus3 and confirming the leak using Enigma.

17.21 SATELLITE LEAK LOCATION – UTILIS

Yorkshire Water, UK, Satellite Leak Detection Program Achieves Water Loss Reduction of 4500 m³ per Day

Yorkshire Water (YW) is one of the largest water utilities in the UK, serving 5.4 million customers, and has a mandate from Ofwat to reduce its real water losses, or leakage, by 40% by 2025. YW is committed to finding and fixing leaks in the water distribution system in order to meet the regulatory requirements imposed by Ofwat. YW retained Utilis to provide satellite leak detection services in order to help meet this goal at the lowest cost and in the least amount of time. YW has executed three phases of work with Utilis to identify points of interest (POI) and direct boots-on-the-ground (BOTG) staff to the most likely leak locations. The goal is to efficiently and cost-effectively reduce water loss from the 33,000 Km YW system which serves 1.24 billion litres of water per day. YW has a water loss rate of 290 MLD or 7575 litres per kilometre per day, at the beginning of the work program.

Pursuant to the three satellite images a total of over 250 leaks have been found and water loss reduction is calculated to be 4500 m³ per day. YW crews found 195 leaks via the satellite directed protocol as compared to 56 using the traditional point-to-point inspection program, a 250% increase over the same time scale. Using the Utilis program 8 leaks per person were found as compared to 6.5 with the traditional method. Almost 5 leaks per day were identified using the Utilis satellite triage program. Overall it took more than two days longer to locate a leak using traditional methods than with the satellite triage method, thus the Utilis method significantly reduced the cost to find a leak.



Figure 17.21.1 Leaks were found in difficult to inspect areas, high groundwater and beneath structures. (Source: Utilis)

17.22 SOFTWARE-BASED SOLUTION

Transforming a hidden leak into excellent customer service February 2019, Takadu

Background

Jyväskylä Energy Group, a world-class water utility located in Central Finland’s largest city, has a three-year service contract with TaKaDu to increase the efficiency of its water-network management. The project was overseen and implemented by Pisara, Jyväskylä Energy’s smart water solutions unit. Since implementation, TaKaDu’s Central Event Management (CEM) solution has helped Jyväskylä Energy to improve its operational efficiency, save energy and water, reduce repair costs and improve customer service. Based on big data analytics, TaKaDu’s cloud-based solution enables utilities to detect, analyse and manage potential events and incidents, such as leaks, bursts, faulty assets, telemetry and data issues, operational failures and other anomalies.

Hidden leak event “lifecycle”

In November 2018, TaKaDu detected an anomaly in the water supply of one of its sub-divisions under the management of the municipality, Uurainen. Located near the city of Jyväskylä, Uurainen buys water from Jyväskylä Energy under exceptional circumstances.

TaKaDu’s advanced analytics technology classified the anomaly as a potential leak with all the relevant information (magnitude, zone, start time, etc.), and alerted Jyväskylä Energy’s analysts. Following internal verification, the analysts contacted the Uurainen municipality’s network manager and asked them about the extra water consumption, and to check for a possible leak in their network.

Uurainen started to investigate and no leaks were found in their main network. After confirming that it was not in their central network, Uurainen published a release to their residents and the smaller operators, who purchase water from them, to inform them about a possible leak and to ask them to check their systems.

After a short time, one of the operators found the leak in their network and quickly fixed the problem. The whole process took one week in total, from the time TaKaDu detected the ‘event’ until the time the leak was repaired before it turned into a ‘sudden’ burst. The repair was also confirmed by TaKaDu verifying that the consumption pattern was back to normal behaviour.

Results: significant water and cost savings

Due to the early detection of the leak, Uurainen (a sub-network of Jyväskylä) benefited from significant water and cost savings, since they are billed for all their operators’ water consumption. The hidden leak event could have gone on for weeks or months, before showing up in the system or outside.

Uurainen had not detected the water loss by its own reports, and it had not been reported by anyone in the community. Hidden leaks such as these can remain hidden for weeks or even longer until someone notices a burst.

From its detection until repair, the estimated water loss during the week was 1,530 m³ at a cost of EUR 3,000. If the leak had continued, the water and financial loss could have been huge, as shown in the table below.

Summary

Jyväskylä Energy showed its commitment to customer service, responding quickly to the problem. Even though this billable water was paid for by Uurainen, Jyväskylä Energy was committed to resolve the event quickly, sharing the information they had as quickly as possible. Through the early detection and fast communication with the relevant stakeholders – inside the utility itself, with Uurainen and between Uurainen and its consumers – the detection and repair cycles were relatively short, preventing serious damage later.

TaKaDu was the only network solution which detected the problem, before any disruption to the public. From detection until resolution, TaKaDu acted as the centralized platform for managing the entire life-cycle of the event and streamlining the communication channels.

“TaKaDu’s CEM played a crucial role in finding this leak quickly and enabling an efficient management layer for the utility’s decision makers. If it had carried on for a long time, the leak could have caused water and financial losses. The faster a leak is detected, the easier and cheaper it is to repair. Using TaKaDu’s technology, we can offer the highest levels of service to our customers.”

Pasi Jalonen, Executive Vice President, Smart Water Solutions, Pisara/Jyväskylä Energy Ltd.
Event detection and start time – 25/11/2018

Table 17.22.1 Estimated water loss and cost (€).

Time Period	Estimated Water Loss (m ³)	Cost (Euros)
1 month	6,261	12,272
3 months	18,783	36,815
12 months	76,176	149,305



Figure 17.22.1 Event lifecycle in TaKaDu. (Source: Takadu)

Event closing time – 2/12/2018

Event duration – 1 week

Estimated water loss – 1,530 m³

17.23 REDUCING NRW IN WILSON COUNTY – TENNESSEE

Cavanaugh Solutions

The Water and Wastewater Authority of Wilson County, Tennessee (Authority) is located just east of Nashville, Tennessee, USA. The Authority was established in 1975 with a governing Board of Commissioners appointed by the County Mayor and approved by the County commissioners and does not have any power to levy or collect a tax. Today, the Authority distributes potable drinking water through 345 miles of nearly 100% PVC water mains ranging in size from 2 to 10 inch diameter to 21,000 residents through 7,725 service connections. It is a relatively new system with the oldest portions installed in 1971 which were part of a distressed water system acquired by the Authority. The Authority purchases 100% of the water as treated water from four (4) difference suppliers.

In 1988, the Tennessee Department of Economic and Community Development, Energy Division understood the relationship between water leakage and wasted energy used to pump that water and therefore funded the multimillion dollar Tennessee Energy and Water Conservation Program to perform water audits, meter testing and leakage control surveys on nearly 400 water systems throughout Tennessee. Senator Robert Rochelle gathered legislative support to use the state "oil overcharge funds" to pay for the program which was then selected by the U.S. Department of Energy for inclusion in the National Awards Program for Energy Innovation. The Authority stepped up and volunteered to be the first system to participate in this program. The water audit performed in 1988 calculated 70.368 million gallons per year of potential leakage over the total water system which consisted of 129 miles of distribution main and 1,923 service connections. An acoustic leak detection survey was conducted and an estimated 51.509 million gallons of leakage per year was identified. No main line leaks were found and the majority of the located leaks were not surfacing. The Authority then purchased a potable acoustic leak detector which was used to pinpoint known leaks. When major non-surfacing leakage issues occurred, such as a storage tank not filling, the Authority would contract a local water loss consultant which used a noninvasive strap-on ultrasonic flow meter to identify the area of excessive flow and sounded that area to locate and pinpoint the leakage. Around 1999, Authority personnel received additional training on acoustic leak detection and would conduct sounding if the 24-hour totalized flow on a system import meter from a water supplier was higher than normal or excessive flows occurred from storage tanks.

The present executive director of the Authority was the project manager for the consulting firm in 1988 which conducted the statewide Tennessee Energy & Water Conservation Program. Discussions in the 1990s with Energy Division staff occurred around developing a "smart system" concept to identify the occurrence of leakage; but technology and concept support did not exist back then. In 2006, he joined the Authority as an employee and farther advanced the in-house water loss control program. A goal was established to develop a more robust leakage control program by measuring the actual leakage within smaller sections of the distribution system to prioritize leak detection efforts and then establish an on-going monitoring program to determine when to intervene and in which specific areas of the system. Field work over the years confirmed that the vast majority of main line leaks are not detectable on this PVC system by direct contact with system appurtenances using acoustic leak detection equipment. Ground miking directly over the main is required to hear the non-surfacing main line leaks. This approach is extremely time consuming and with mains located under soiled conditions in private easements outside the road right-of-way, the leak noise may not be audible if listening more than a few feet from the main. Leak noise correlation techniques have limited success due to PVC and long distances between direct contact points. Correlation hydrophone technology appears slightly more effective but still extremely time consuming. End result, one must determine the general location and rate of leakage to deploy appropriate technology to pinpoint the exact leak locations. This can only be accomplished cost effectively by establishing district metering to discreet District Metered Areas (DMAs), Minimum Night Flow analysis (MNF) and Step Testing. In 2006, the Authority purchased a portable noninvasive strap-on transient time flow meter, two pressure loggers and a few more acoustic leak detectors and began establishing temporary DMAs. In addition, existing SCADA on each storage tank was programed to calculate the tank drop flow rate in gallons per minute during the MNF period when not pumping to the tank. In 2014, the advancements in data gathering and communications technology allowed the Authority to move beyond data logging and on-site downloading to real-time data collection and communications via cellular to SCADA historian. The Authority constructed 23 permanent DMAs based upon the existing system import meters from suppliers, pump stations, ground storage facilities and PRVs utilizing existing radio frequency SCADA and additional cellular real-time telemetry with

smartphone communications to SCADA and also directly to cellular sites bypassing SCADA for real-time data during Step Testing implementation. Event detection based on flow and pressure data thresholds was established for each DMA for notification alerts.

The Authority uses the AWWA Free Water Audit Software (FWAS), a regulatory requirement in the state of Tennessee, with many years of Level 1 validation. The FWAS calculates the various Performance Indicators (PIs) including the Infrastructure Leakage Index (ILI) which is the ratio of the Current Annual Real Losses (leakage) to the Unavoidable Annual Real Losses (UARL). In addition, the Authority uses the AWWA Water Audit Software Compiler to provide year-to-year analysis and performance comparisons of the DMAs. Recovery of leakage is a must because the Authority purchases 100% of its supply therefore the variable production cost is very high justifying target setting to the technical minimum $ILI=1.0$. Note, an economic analysis should be performed to determine a goal based on the various PIs looking at the cost of achieving the goal versus the actual cost savings of the recovered lost water. The MNF period for the Authority in residential area DMAs is 1:30AM – 3:30AM. The initial MNF period targets per DMA set years ago were based on the UARL calculated from the FWAS converted to gallons per minute plus a Legitimate Nighttime Consumption (LNC) factor of 1.5 gallons per hour per connection converted to gallon per minute flow. Note, future planned AMI/AMR deployment will allow analysis using actual consumption versus present estimated LNC. As leakage is reduced new targets may be set based upon improved DMA performance. At present, the MNF will actual go to zero gallons per minutes for periods of time in some of the smaller DMAs as shown in Figure 1. If the MNF exceeds the target in a DMA then Step Testing is implemented in which a series of valves identified through GIS are isolated within the DMA and flows measured and analysis conducted to quantify the amount of leakage within specific areas of the DMA to target acoustic leak detection. An isolation valve creating an actual step to stop flow into an area is isolated for no longer than 5 minutes to prevent depressurizing the area. In addition, procedures for back-feeding DMAs of similar pressures have been implemented to eliminate potential depressurizing and recharging allowing for longer periods of analysis increasing analytical accuracy. Decisions are made real-time and the process can easily cover 50 miles of main within the two hour MNF period. The process normally identifies a range of a few thousand feet to a few miles in total for targeted leak detection rather than the total 50 miles significantly reducing the time needed to locate and repair leaks.

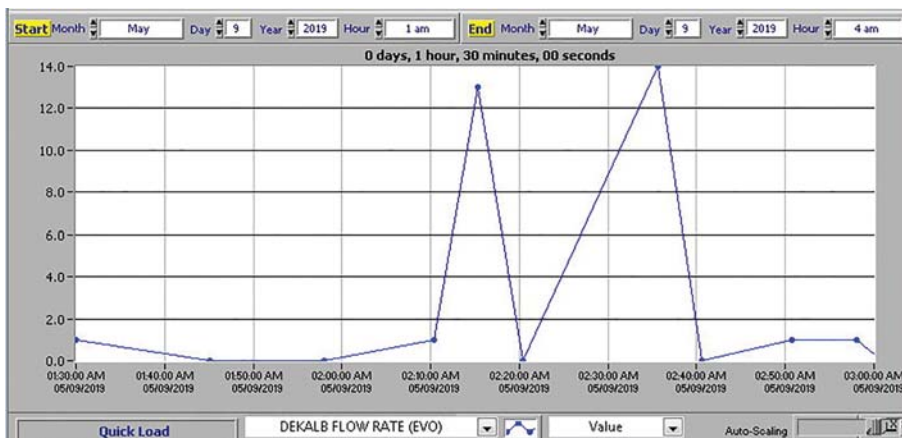

Figure 17.23.1 MNF goes to zero gallons per minute. (Source: Cavanaugh)

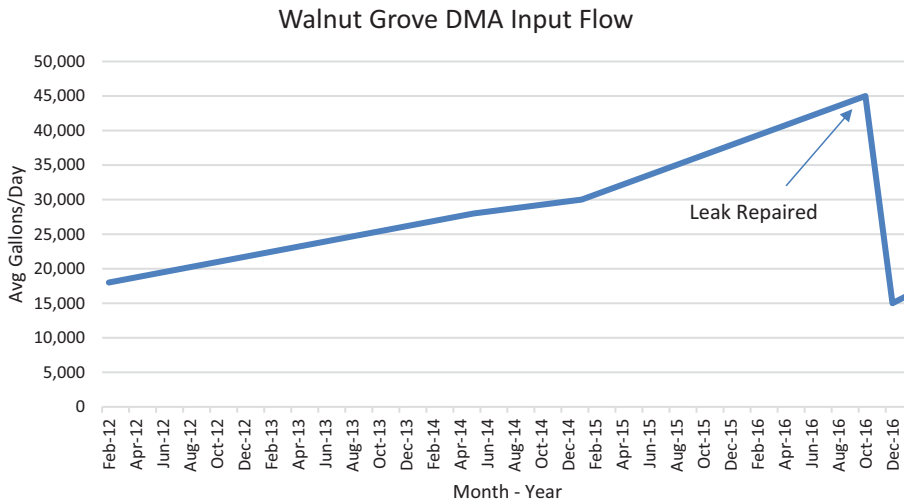

Figure 17.23.2 Main break running from 2012 to 2016. (Source: Cavanaugh)

DMA data yields factual leak runtime data. Figure 2 is a good example where permanent real-time DMA monitoring was installed in October 2016 and the MNF analysis revealed a potential 20 gallon per minute leak. After repaired, prior daily totalized manual 24-hour reads on this water supply import meter were reviewed and confirmed the main break began around February 2012 at a much lower rate. Figure 3 shows real-time DMA monitoring catching a main break leak starting at a very low rate and growing to over 30 gallons per minute within one month. The main breaks in Figure 2 and Figure 3 were only able to be located by DMA Step Testing and ground miking directly over the main. Both repair excavations were completely dry until the water main was exposed. Both DMA MNF valves went to zero gallons per minute after break repairs were completed.

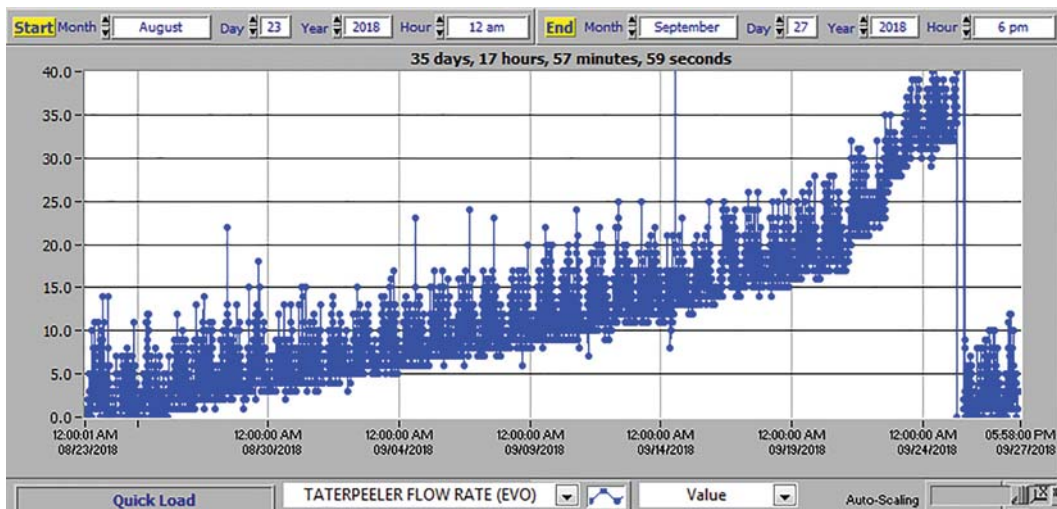

Figure 17.23.3 Main break began and grew to 32 gallons per minute. (Source: Cavanaugh)

Implementation of these advanced leakage control methodologies have been very cost effective and do provide additional data for insight to potential causes of leakage. The vast majority of main breaks for the Authority occur due to poor installation years ago because the service area is very shallow to bedrock requiring blasting and rock trenching for installations and installation inspections were lacking. Many main break repairs will reveal rock against the pipe and over time appears to have compromised the pipe integrity. Service line leaks are typically splits on black roller plastic and corrosion on copper services. Advanced monitoring in real-time has identified system operational issues causing pressure transients which most likely amplifies the impact of poor installation. For the Authority, pipeline replacement is not the first line of defense. Proactive identification of leakage occurrence, pinpointing and repairs along with pressure and transient management tools such as PRVs in the system and soft starts at pump stations and training of fire hydrant operations are key to reducing losses due to excessive leakage run-time and reoccurrence of leakage due to excess pressure and transients. Figure 4 documents a transient pressure break created when the storage tank was full and the pump station shut off.

The Authority began its active leakage control journey back in 1988 at which time the Authority's Real Losses (leakage) was 70.368 million gallons per year over 1,923 service connections and 129 miles of distribution main versus 2018 water audit Real Losses of 90.605 per year over 7,725 service connections and 345 miles of distribution main yielding the following normalized PIs:

Real Losses Performance Indicator	Year 1988	Year 2018
Gallons/connection/day	100	32
Gallons/mile/day (refer to Figure 5)	1,498	720

Since 1988 the quantity of system main line infrastructure has increased by 167% and number of service connections by 302% but the annual quantity of Real Losses only increased by 29% and per normalized PIs losses decreased to 32% of the 1988 level based on gallons/connection/day and 48% of the 1988 level based on gallons/mile/day. Interesting that in 1988 the oldest pipe was only 17 years old yet the level of leakage was excessive indicator that water loss control needs to start from day one. Managing existing infrastructure is of utmost importance!

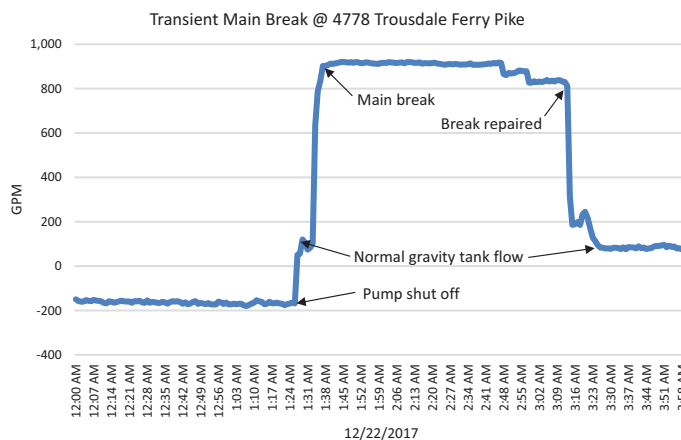

Figure 17.23.4 Transient pressure main break. (Source: Cavanaugh)

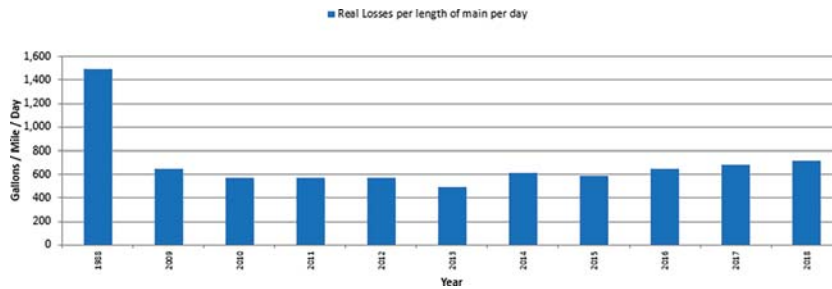

Figure 17.23.5 Real losses 1988 versus 2009–2018. (Source: Cavanaugh)

The Authority has been maintaining an ILI around 1.0 for the past few years while the state of Tennessee filtered FWAS data over the years consistently shows the median state level ILI over 2.0 generally indicating that the Authority's Real Losses level is about half that of the state median level. The Authority's active leakage control program using DMAs calculates a net financial benefit of approximately \$42 per billed customer per year and simple payback of approximately 10 months if compared to the Authority performing equal to the median ILI level in Tennessee. Other utilities are now implementing these more advanced cost effective methodologies and reducing system leakage.

Chapter 18

Appendices

Paper 1: Water balance – From the desktop to the field

B. Charalambous¹ and S. Hamilton²

¹*Hydrocontrol Ltd, Lemesos, Cyprus. E-mail: bcharalambous@cytanet.com.cy*

²*Hydrotec Ltd, The Barn, Thorpe Underwood, Northamptonshire, NN6 9PA, UK. E-mail: shamilton@hydrotec.co*

Summary: Have you ever wondered what you do with the water balance after the various components have been calculated? Or how you can use the numbers to work out an investment strategy and an action plan and how to prioritise your actions in order to get the best return on your investment? This paper shows how the water balance can be used to derive an action plan for reducing non-revenue water as well as the relevant returns on investment for each action. Also it gives a full working model of how the Water Balance is taken to the next stage. Furthermore it details the actions that are appropriate to be taken for each one of the above main components of the water balance in order to reduce non-revenue water and provides justification for each action proposed. It also expands on current thinking and knowledge in the planning and prioritisation of non-revenue water reduction options that are available to water utilities and recommends a basic action plan matrix.

Keywords: Water Audit, NRW reduction strategies, NRW action plan matrix

INTRODUCTION

Most water utilities use the water balance to calculate non-revenue water and to find the amount of water being lost. It is obvious that this is extremely useful and must be worked out in order to have a clear picture and to account for each constituent component of the water balance.

The planning of non-revenue reduction activities to be carried out and ultimately the compilation of an action plan are based on the findings of the water balance and in particular on the main components, namely, Authorised Billed Consumption, Unbilled Authorised Consumption, Apparent Losses and Real Losses. Depending on the amount of water which is being lost in each one of the above components which comprise the Non-Revenue Water, the action plan is targeted in order to provide the best return with the minimum of investment in the shortest time possible.

Accountability of water is extremely important in this process. This is achieved through a validated Water Audit which could be carried out internally by experience water utility personnel or by external auditor.

WATER AUDIT

A water audit is a thorough accounting of all water into and out of a utility as well as an in-depth record and field examination of the distribution system that carries the water, with the intend to determine the operational efficiency of the system and to identify sources of water loss and revenue loss. It should include but not limited the following:

- A thorough accounting of all water into and out of a distribution system.
- A Water Balance calculation including inspection of system records and data verification.
- A meter testing and calibration program.

A water audit is a critical first step in the establishment of an effective water loss management program. With the successful completion of a system water audit, the utility gains a quantified understanding of the integrity of the distribution system and begin to formulate an economically sound plan to address losses. Water loss in a public water system can be a major operational issue. Non-revenue water components can significantly affect the financial stability of the utility. Addressing the issues associated with the non-revenue components will certainly entail a significant cost for the utility. The economic trade-offs between value of lost water given it generates no revenue and the investment to reduce this loss requires careful planning and economic judgment. The utility needs to clearly understand the type of loss as well as its magnitude. Water resource, financial and operational consequences must be weighed when considering these issues and the decision taken is unique to every system.

A brief summary of the main steps to perform an initial water audit is given below for ease of reference:

- (1) The amount of water put into the distribution system is determined.
- (2) The authorised consumption (billed+unbilled) is obtained from records.
- (3) Water losses are calculated (water losses = system input – authorised consumption).
- (4) Apparent losses are estimated (theft + meter error + billing errors and adjustments).
- (5) Real losses are calculated (real losses = water losses – apparent losses).

The above steps are an example of a top down audit, which starts at the “top” with existing information and records. It may also be known as a desktop audit or paper audit since no additional field work is required. Distribution systems are dynamic. The audit process and water balance has to be periodically performed to be meaningful to a utility’s water loss management program.

After performing an initial top down audit it may become evident that some of the numbers are approximate estimates and inspire little confidence in their accuracy. The next action in the audit process is to refine the quantities that may have been initially estimated and begin reducing non-revenue water losses. A bottom up approach is often implemented after top down audit has been completed which can help in identifying the real losses component more accurately thus adjusting the initial Apparent losses estimate. A bottom up approach will help with finding real losses and begins by looking at components or discrete areas in the distribution system. It also assesses and verifies the accuracy of the water loss data associated with individual components of the distribution system.

It is important to stress that although utility personnel are well experienced and are familiar with the operational characteristics of the network it may be worth while having an external or independent audit carried out. External audits are usually an excellent way of helping water utilities to analyse and improve their data. It must stressed the external audits are an independent process, ensure accurate reporting, improve data collection and accuracy by identifying statistical and reporting errors and is an excellent method of helping utilities to improve their performance.

There are many types of audits that will analyse water use, from distribution system balances to household reviews. The accuracy of results depends on the methods used to generate the data. Audits have an important part to play in the development of strategic action plans for water efficiencies and financial savings as well as short and long term management. Therefore it is vital they are undertaken in ways which ensure that the most accurate data possible is generated (Queensland Environmental Protection Agency/Wide Bay Water, Manual 2, Water Audits p43).

ASSESSING LOSSES – IWA WATER BALANCE

A significant contribution to reaching the point of water accountability was the establishment of the IWA Water Balance (Figure 18.1.1) which is a useful tool in analysing the various components of water production, storage and distribution. Through this analysis the utility will gain an understanding of the magnitude of the water loss problem and will set priorities for rectifying the situation based on the component analysis of the Revenue and Non-Revenue Water elements.

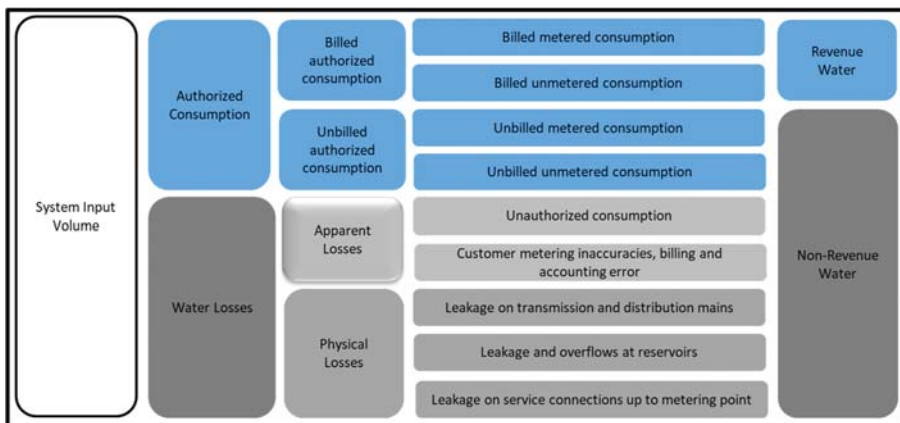

Figure 18.1.1 IWA Water Balance. (Source: IWA Water Loss Specialist Group)

The findings from the water balance and in particular its main components should:

- Assist in estimating the best return with the minimum of investment in the shortest time possible
- Form the basis for planning NRW reduction activities
- Provide sufficient information for an effective action plan

It is strange however, that for a number of reasons instead of following the above desired results a different approach is adopted which follows the steps below:

- Limited and/or unreliable data is used
- Calculate non-revenue water
- Find the amount of water lost
- Do not like the outcome
- Change assumptions made to suit
- Management 'blaming' staff for not doing their job
- Employees pointing out lack of funding, commitment and support by management
- Finally, work out figures to suit management and employees

Obviously the above approach will result in serious problems for the utility and it must be avoided at any cost. The Water Balance is a useful tool which if used correctly it will certainly point the way to the actions and measures that need to be taken to reduce NRW. Answers to the questions below will take you to the next stage from the desk top to the field environment.

- Have you ever wondered what you do with the water balance after the various components have been calculated?
- Or how you can use the numbers to work out an investment strategy and an action plan?
- Or how to prioritise your actions in order to get the best return on your investment?

Answers to the above questions and what could be done with the water balance will be demonstrated using examples from case studies.

CASE STUDY EXAMPLES

Top down approach

In this example the constituent components of the water balance are entered into the water balance using absolute volume figures and working out the corresponding percentage figures (Table 18.1.1). It is this percentage figures which are usually quoted and has to be stressed that they could be misleading as a performance indicator since they are strongly influenced by consumption as well as changes in consumption.

The Non-Revenue Water is often expressed as a percentage of the System Input Volume. However, a true financial performance indicator needs to reflect costs as well as volumes. An improved financial indicator can be used by converting the Non-Revenue Water Volume to values. An example is shown in Table 18.1.2 below where the NRW volumes in the above Water Balance were converted to values using the corresponding unit value for water. The unit value for Unbilled Authorised Consumption and Apparent Losses is usually the average sale price of water to customers. The unit value for Real Losses is usually taken as the marginal cost of water that is the unit cost of producing and distributing water into the network or bulk charge whichever is the higher.

Table 18.1.1 Top down approach using the IWA Water Balance

System Input Volume 11.985.560 100,00%	Authorised Consumption 10.276.626 85,74%	Billed Authorised Consumption 10.216.698 85,24%	Billed metered consumption (including water exported) 10.216.698(85,24%) Billed unmetered consumption Zero	Revenue water 10.216.698 85,24%
		Unbilled Authorised Consumption 59.928 0,50%	Unbilled unmetered consumption Zero Unbilled unmetered consumption 59.928 (0,50%)	Non-Revenue water 1.768.862 14,76%
	Water Losses 1.708.934 14,26%	Apparent Losses 299.639 2,50%	Unauthorised use 59.928 (0,50%) Metering inaccuracies 239.711 (2,00%)	
		Real Losses 1.409.295 11,76%	Real losses on raw water mains and at the treatment works Zero Leakage on transmission and/or distribution mains 80.458 (0,67%) Leakage and overflows at storage tanks 11.986 (0,10%) Leakage on service connections up to the metering point 268.913 (2,24%) Detectable Losses 1.047.938 (8,74%)	

Table 18.1.2 Converting NRW Volume Components to Values

Non-Revenue Water 1,768 862 m ³	Components of Non-Revenue Water	Assessed unit value of NRW component	Assessed total value of NRW component	Assessed total value of Non-Revenue Water € 1127 436
	Unbilled Authorised Consumption 59 928 m ³	1,2 €/m ³	€ 71 914	
	Apparent Losses 299 639 m ³	1,2 €/m ³	€ 359 567	
	Real Losses 1 409 295 m ³	0,8 €/m ³	€ 1 127 436	

From [Table 18.1.2](#) it can be seen that the Real Losses have the biggest financial loss for the utility and it is evident that this area is critical and should be examined further. This examination should provide proof that repairing the leaks and savings this amount of water which is being lost makes financial sense for the utility. In order to arrive at this result the following methodology needs to be followed.

From the top down analysis in [Table 18.1.1](#) the amount of detectable losses are 1047938 m³. This figure is equivalent to a Night Line reduction of 1 047 938 m³/365 days/20 hrs = 144 m³/hr. Assuming an average leak of the order of 1.6 m³/hr then the number of equivalent leaks that should be located and repaired is 90. Given that the network length is 345 km it works out that there is on average 1 leak every 3.83 km. Assume a leakage detection team comprises 2 technicians with an average output of 2.5 km per day, 5 day working week and a weekly charge of €5000/week. The average number of leaks found by the team per week is $5 \times 2.5/3.83 = 3.26$, say 3 leaks found per week. The total time required to find all leaks will be 90 leaks/3 = 30 weeks. Based on the above the following financial calculations can be made

- Total Cost for locating leaks = $30 \times €5000 = €150\ 000$
- Total Cost for repairing leaks = $90 \times €1500 = €135\ 000$
- Water Saving = $1\ 047\ 938\ \text{m}^3 \times €0.8/\text{m}^3 = €838\ 350$
- NET SAVING = $€838\ 350 - €150\ 000 - €135\ 000 = €553\ 350$

It obvious from the above calculation that the utility will have a considerable saving by moving forward with repairing the leaks first and an action plan to this effect should be work out.

In order to highlight a different approach to the above the apparent losses in [Table 18.1.2](#) are increased with the corresponding reduction in the real losses. The revised figures are shown in [Table 18.1.3](#) below.

In this instance the action plan needs to be different to the above for the following reasons:

- The Apparent Losses are almost equal to Real Losses in terms of revenue loss
- Need to deploy a strategy that will maximise benefits
- Tackle apparent losses with the minimum expenditure; reduce unauthorised consumption, meter reading and accounting errors at the first instance which will increase revenue.
- Simultaneously reduce leakage in order to save money in producing/buying less water.
- Invest savings in further reducing Apparent and Real Losses.

Table 18.1.3 Converting NRW Volume Components to Values (Revised). Water balance – From the desk top to the field

Non-Revenue Water	Component of Non-Revenue Water	Assessed unit value of NRW component	Assessed total value of NRW component	Assessed total value of Non-Revenue Water
1768 862 m ³ (14,76%)	Unbilled Authorised Consumption 59 928 m³ (0.50%)	1,2 €/m³	€ 71 914	Water €1 678 917
	Apparent Losses 599 639 m³ (5,00%)	1,2 €/m³	€719 567	
	Real Losses 1109 295 m³ (9.26%)	0,8 €/m³	€887 436	

Bottom up audit – case study to show bottom up and top down comparisons

In this example it is explained how the bottom up audit is extremely useful in complementing the top down approach. The case study data used are of the area of 'Sky' in Piraeus, Greece (Kanellopoulou, S., 2011). The main characteristics of the area are as follows:

- Length of network = 56km
- Number of consumers = 16840
- Service connections = 4000

A top down approach is carried out and the result is given in the table below. It should be noted that under the Real Losses the two main constituent components are included:

- Background Leakage on mains and service connections, and
- Detectable Losses

In order to verify the assumption made for the Apparent Losses a bottom up audit will be carried out based on measured values. The Minimum Night Flow (MNF) as measured is shown in [Figure 18.1.2](#). The Minimum Night Flow is 55 lit/sec (198 m³/hr). Based on this measured figure a bottom up audit is carried out of the constituent components of the MNF in order to arrive at the amount of potentially detectable losses as shown in [Table 18.1.4](#).

As it can be seen from [Table 18.1.4](#) below the potentially Detectable Losses are 2352 m³ per day compared to the overall figure of 2631 m³ per day estimated for all Real Losses in the system using the Top Down approach ([Table 18.1.5](#)).

This exercise shows that the initial assumption for Apparent Losses is reasonable and the NRW reduction plan should concentrate on reducing the Real Losses particularly in locating and repairing the leaks in the distribution network. The potentially detectable losses comprise 89% of the overall Real Losses which is of the right order considering that apart from a small percentage of Background Losses and Customer Night

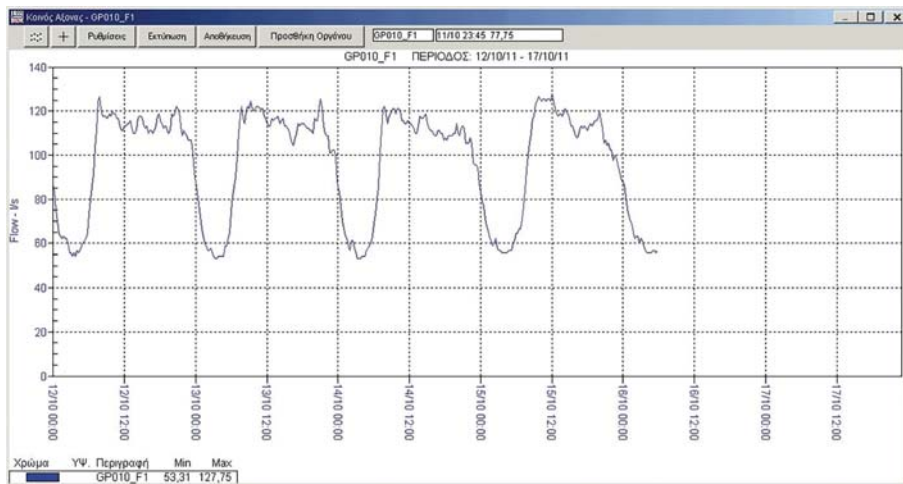

Figure 18.1.2 Minimum Night Flow Diagram for the area of Sky, Piraeus, Greece. (Software: Intranet telemetry application, 2006, EYDAP, Athens, Greece)

Table 18.1.4 Bottom up audit for the area of Sky, Piraeus, Greece

Description	m ³ /hr	Daily (m ³)
Minimum Night Flow (measured)	198	198 × 20 hr = 3960
Background Losses (calculated)	21	21 × 24 = 504
Customer Night Use	46	46 × 24 = 1104
Potentially Detectable Losses	3960-504-1104	2352

Table 18.1.5 Top down approach for the area of Sky, Piraeus, Greece

Description	m ³ /year	Average Daily Volume (m ³)
Input volume	2 898 100	7940
Construction	1 881 575	5155
Non-revenue water	1 016 525	2785
Unbilled Authorised Consumption (measured)		26
Apparent Losses (assumed 2.5% of consumption)		129
Real Losses		2630

Use the remainder is attributed to losses in the distribution network which could potentially be located and repaired. Of course the Economic Level of Leakage must be taken into consideration in deciding how much of the amount of potentially detectable losses is financially worthwhile recovering.

Benchmarking of non-revenue water

It is extremely useful to have a matrix which could be used to benchmark the performance of a utility based on the NRW figures.

The authors have developed and are proposing for use an action plan matrix which is based on the percentage of System Input Volume for each constituent component of the Non-Revenue Water. The action plan matrix which is shown in [Table 18.1.6](#) provides guidance as to the general actions that could be taken depending on the percentage figure in order to reduce the NRW in each component.

Of course the proposed matrix is only a guideline and much more investigation and development of this Matrix is required. The intention is to provide a guideline as to the general actions required which could be carried out by the utility whilst collecting and validating further data and information for more detailed analysis which will result in specific water loss management strategies.

CONCLUSIONS

It could not be stressed enough that utilities must target their actions and investments in order to get the maximum benefit. To achieve this it is important to have the necessary knowhow either internally or externally in order to be in a position to justify a proposed NRW reduction action plan which above all

Table 18.1.6 Proposed action plan matrix for NRW

Water Balance Component	% of System Input Volume	Suggested Action
Unbilled Authorised Consumption	Up to 1%	Considered within acceptable limits
	1% to 5%	Introduce new tariffs
	5% and above	Review overall billing policy
Apparent Losses	Up to 2%	Considered within acceptable limits
	2% to 5%	Reduce unauthorised consumption, meter reading and accounting errors
	5% and above	Review metering accuracy/policy
Real Losses	Up to 5%	Considered acceptable, may be uneconomic to reduce
	5% to 10%	Reduce visual leakages and overflows at storages and fix visual network leaks
	10% and above	Improve active leakage control, effective maintenance, pressure management

should be financially viable and sustainable. Needles to say in order to carry out such a plan the right level of knowledge and experience are required.

So, tackle first whatever gives you the quickest revenue return which will provide money for the longer term savings – think of the returns and not get caught up in the expensive solutions because it may be more attractive.

It is important to be understood that the Water Balance is the starting point for any NRW work. This paper aims to show that this could be done at the very early stages without having to wait until DMAs, pressure management, and so on. are set up and data collected and analysed.

The Water Balance provides sufficient information to assist in the drafting of a NRW master plan in order to move ahead with water loss reduction and in parallel to make strategic improvements to the network. In the past it was thought necessary, mostly in developing countries, to develop DMAs in order to drive a NRW reduction master plan. The authors are suggesting that this could be done in parallel and that in the initial stages the Water Balance is the vehicle for driving a NRW Master Plan.

FURTHER READING

Lambert A. (2003). Assessing Non-Revenue water and its components. *Water21*, 5(4), 50–51.

Queensland Environmental Protection Agency & Wide Bay Water (2002). Managing and reducing losses from water distribution systems. Manual 2, Water audits, Brisbane, Australia, pp. 9, 43 and 54.

Paper 2: Intermittent supply leakage nexus – Dealing with the complex interrelation of intermittent supply and water losses

Bambos Charalambous¹ and Roland Liemberger²

¹*Hydrocontrol Ltd, PO Box 71044, Lemesos 3840, Cyprus.*

Email: bcharalambous@cytanet.com.cy

²*Miya, Shaul Hamelech Blvd 23, Tel Aviv, Israel. Email: roland.liemberger@miya-water.asia*

Abstract: In many world regions Intermittent Water Supply (IWS) systems are prevalent. It is evident from the results presented in this paper that although intermittent water supply may seem to be a solution to a water shortage situation in overall terms the water balance is adversely affected. Supplying less quantity in an intermittent manner causes such deterioration to the network that when continuous supply is re-established additional quantities are lost through increased leakage, which in fact places an added financial burden on the utility. It is therefore evident that no matter how good a network is, intermittent supply operation has definitely a detrimental effect on its integrity and in addition the amount of water ‘saved’ is later ‘lost’ and in greater quantities through increased levels of leakage. Such operational conditions should be avoided especially in pipeline networks that have been designed for continuous supply. In addition it has been shown that the domestic demand is in effect inelastic and in fact the quantities of water saved by the customers were very small. It is the authors’ opinion that better results could be achieved through a structured conservation programme rather than intermittent supply. Of course such programmes are to be introduced as part of an overall strategy for water conservation both on the supply and demand side

Keywords: Intermittent water supply, water losses, continuous supply

GENERAL

IWS systems can be defined as piped water supply service that is available to consumers for less than 24 hours per day. In Latin America and the Caribbean, it is estimated that 60% of the population is served by household connections having intermittent service (PAHO & WHO 2001). In Africa and Asia, it is estimated that more than one-third and one-half of urban water supplies respectively, operate intermittently (WHO & UNICEF 2000).

In an IWS situation, the consumers usually secure their water supply through the use of ground and/or roof tanks or smaller capacity individual containers, where water is stored during the length of time that the supply is provided in order to be used during the period that the supply cut-off. It is worth noting that IWS is enforced not only in cases where there is water shortage but also where the hydraulic capacity of distribution networks is such that cannot satisfy demand as well as in cases where the network is severely deteriorated resulting in high leakage.

In many instances there is no indication how long intermittent supply will be in place. In many countries around the world IWS is the norm rather than the exception. The hydrological conditions in each case could impact adversely on water supply for years in which case conserving as much as possible the limited water

resources may not be the long term solutions but it may be necessary to add to the water balance new non-conventional water resources. In many countries water shortage problems were overcome through the desalination of brackish or saline water. Of course exploring every potential water source available may be the only solution in many instances, but leakage reduction is always one of the least expensive and quickest solutions to ensure that water will be available when needed.

It is generally considered that IWS is not an ideal form of supply and should not constitute a permanent solution however it is applied by many water utilities with great ease mainly as a measure for dealing with water shortage or drought conditions without seriously looking into alternative solutions. It is also the authors' experience that some water utilities are applying IWS as a measure to reduce extremely high leakage from their networks which of course prevents them from maintaining a continuously pressurised network with all the adverse repercussions.

Even though in a number of instances it may not be possible to avoid IWS, the advantages of IWS if any, are very few and lack substance in order to convince that the use of intermittent supply is a sustainable modus operandi for water distribution networks. Intermittent supply is usually introduced either as an emergency measure, when the water availability is limited or in some cases it is introduced as a measure to control water use and to reduce leakage. In the first case when there is limited water availability, there may be no alternative to the rationing of water and an intermittent supply cannot be avoided once the supply resource has been depleted. In the second case, however, where the intermittent supply is introduced as a water saving measure there may well be alternative interventions that can provide savings without some of the problems that tend to accompany such pressurising and depressurising of the distribution network (Mckenzie, 2016).

In many systems IWS was not an element of initial system design but rather reflects a combination of deteriorating infrastructure and demand growing beyond design limits. A possible combination of factors, such as: water scarcity, prolonged drought periods, population growth, urbanisation and increasing demand, lack of awareness and forward planning may have been the root causes of IWS for many water utilities. Inevitably IWS is the cause of serious problems in the proper operation and management of a water distribution network.

The Vicious Cycle of IWS

Normally water reticulation networks are designed to provide piped water on a continuous basis without any discontinuity in this supply apart from extremely short intervals where the supply is cut-off for routine maintenance or fixing of pipe breaks. However, in some instances changing hydrological conditions may result in water shortage and the water utilities are unable to meet existing needs. In some geographical areas this situation may take the form of a cyclic phenomenon where periods of low rainfall are repeated every few years, resulting in water rationing and the temporary application of IWS (Charalambous, 2009) applied as a measure to deal with such circumstances (Figure 18.2.1).

Implications of IWS

Although intermittent supply is usually introduced either as an emergency measure or as a measure to control water use and to reduce leakage it is however a situation worthwhile avoiding through proactive planning and timely response to critical conditions. The adverse effects of intermittent supply on water quality, customer service and integrity of the distribution network as well as the financial repercussions to the utility are highly significant. Some of these are analysed below.

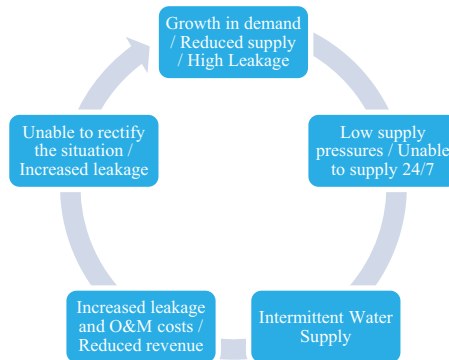

Figure 18.2.1 Vicious Cycle of IWS. (Source: Author)

Water quality deterioration/Health hazard

Intermittency entails a high risk of contamination, which creates substantial health hazards. The first route is the ingress of contamination through broken pipes or joints. Interruption of supply normally creates low pressures or even a vacuum condition in pipelines that last for a significant period of time. Consequently, potentially contaminated water, such as rainwater, sewage spills, latrine drainage, etc. may enter the system through the breaks in the pipe walls when supply is off.

It is difficult to keep proper chlorination level in the network since there are no constant hydraulic conditions with the repeated emptying and charging of the network. In order to deal with such situation it is normal to significantly increase chlorination which of course entails other dangers such as the potential creation of Trihalomethanes (THMs). Trihalomethanes are formed as a by-product predominantly when chlorine is used to disinfect water for drinking and result from the reaction of chlorine with organic matter present in the water being treated. The THMs produced have been associated through epidemiological studies with some adverse health effects and therefore limits are set on the amount permissible in drinking water. In addition excessive chlorination would not be acceptable to consumers as they would not be to deal with such high levels of contamination.

Inequitable distribution within a network

In distribution systems designed on the concepts of 24-hour supply flow depends on pressure head. When the network is charged much higher peak flows than expected will occur in the pipelines thus increasing pressure losses in the network. Consequently, consumers furthest away from supply points will always receive less water than those nearer to the source (Gottipati et al., 2014). This will also be associated with low supply pressures, particularly in high ground areas and/or areas furthest away from the source.

Water wastage

Consumers exposed to IWS conditions are likely to keep their taps open to obtain as much water as possible whenever the service resumes. In addition consumers usually remove the control valves that are installed in the ground and/or roof tanks in order to increase to remove any flow restriction hoping to get larger volumes of water in a shorter period of time. Under these circumstances consumers experiencing IWS are likely to waste more water than those who receive a 24/7 supply from the fear of not having sufficient water they will tend to store as much as possible which is usually replaced by the fresh supply of the next day. Unfortunately

for the less fortunate consumers who do not have the means of installing ground and/or elevated tanks are forced to manage with the small quantities that they have managed to store in their individual containers.

Inconvenience and high coping costs for consumers

Inconvenient supply times mostly affect the poor, since consumers have to pay for storage and pumping. Alternatively, they will have to go to public taps, sometimes quite faraway and even during midnight, to collect water. Long distances and queues are typical problem of women and children from underprivileged areas, taking lots of productive time from them (Totsuka et al., 2004). Resulting from intermittent supply, the consumers have to pay the costs, so called coping costs, for additional facilities, such as storage tanks, pumps, alternative water supplies and household treatment facilities. The poor who cannot afford such facilities spend their time to fetch water from public taps or vendors at comparatively high total costs. Figure 18.2.2 (Chary, 2009) shows the direct costs that IWS inflicts on water consumers, rich people cope by spending money on water tanks, pumping systems and filters whereas middle-income groups spend less on capital equipment but more in terms of time and power. For the low-income group however the coping cost is primarily the opportunity cost of the time they must spend collecting water.

Meter malfunctioning and accelerated wear and tear

IWS would cause inaccuracies in meter registration. Meter registers might reverse due to vacuum conditions created during emptying of the network as supply is cut-off. Air expelled from the pipes during filling might drive meters at excessive speed during the charging stage after the supply has been resumed resulting in the accelerated wear and tear of the registration mechanism. Undesirable environment, such as repeated dry and wet conditions, would accelerate the performance deterioration of water meters. Meter malfunction brings difficulties for water providers to monitor the water use and collect accurate tariffs. Furthermore, it makes consumers sceptical to the accuracy of their water bills relating to the meter registration.

On the whole IWS has a detrimental effect on the network, results in ineffective supply and demand management, inefficient operations, increased difficulties in detecting and fixing leaks as well as greater number of illegal connections.

Myth busters

Over the years a number of misconceptions have been linked to IWS, particularly relating to leakage and customer consumption. Based on their own experiences as well as data and information provided by colleagues, the authors' set out below evidence which clearly shows that the "myths" build around IWS

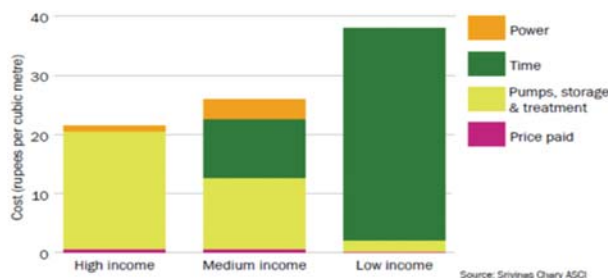

Figure 18.2.2 Coping cost of IWS. (Source: Author)

Leak Detection: Technology and Implementation

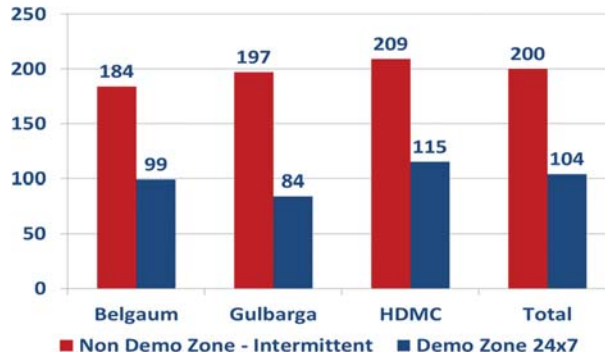

Figure 18.2.3 Water distributed in litres per capita per day. (Source: Anand Jalakam)

are just not true, such as under an IWS regime the NRW is lower compared to 24/7 supply or the volume of water distributed under IWS is less compared to 24/7 regime. Analytically the “myth busters” are presented below.

Is distributed water less under IWS?

It has been considered that under IWS conditions the volume of distributed water is less than the volume needed under a 24/7 supply regime. However, evidence from the Karnataka Demonstration Project (Jalakam, 2014) demonstrated that this is not the case as it can be seen from Figure 18.2.3.

The volumes of water which were distributed to the demonstration zones in each city were far less compared to the volumes that were distributed to the areas of each city under IWS. In fact the numbers show that on average for the 3 cities the volume distributed to the network under IWS was the equivalent of 200 litres per capita per day compared to 104 litres per capita per day for the demonstration zones which were under 24/7 regime, that is 50% less water on average was distributed under the 24/7 regime in the demonstration zones.

Is IWS an effective leakage reduction measure?

Data and information relating to leakage were collected and analysed for a distribution network which was operated over a two-year period under an IWS regime (Charalambous, 2012). Figure 18.2.4 shows the total

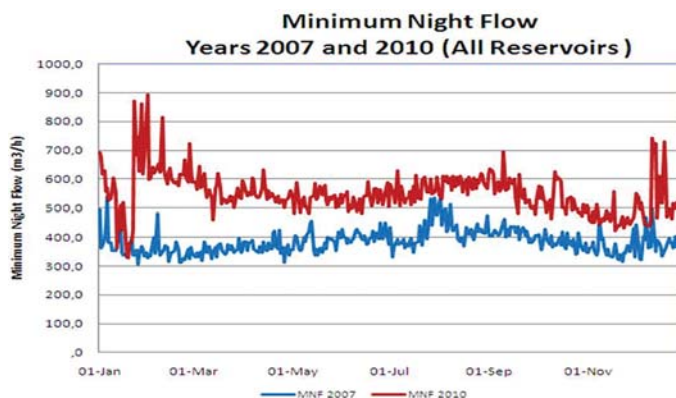

Figure 18.2.4 Minimum night flow before and after IWS. (Source: Author)

Table 18.2.1 Effect of intermittent supply on reported pipe bursts

Description	Number of Reported Breaks		
	Before (Year 2007)	After (Year 2010)	% Increase
Mains	14 per 100km	42 per 100km	200
Service Connections	15.5 per 1000	29.7 per 1000	100
20 DMAs: 373 km (45% of total length of the distribution network) IWS period 2008–09			

Minimum Night Flow before (blue colour) and after (red colour) the intermittent supply. It is evident that there has been a significant increase in the Minimum Night Flow which was attributed to the additional breaks which the network suffered during the two years of intermittent supply period.

Further analysis of case study data showed that there was a large increase in the number of reported pipe breaks during the period of intermittent supply. In order to quantify these a comparison was made for a large number of District Metered Areas, covering a length of network of 373 km corresponding to 45% of the total length of the distribution network, between the breaks reported in 2007, before the intermittent supply was applied, and those reported in 2010, the first year immediately after the measures were lifted and a 24/7 continuous supply was in place. The results are shown in [Table 18.2.1](#) covering both mains and service connections.

This comparison showed that the number of breaks on mains increased from an average of 14 per 100 km of mains to 42 per 100 km of mains, an increase of 200%. Similarly the number of reported service connection breaks increased from an average of 15.5 per 1000 connections to an average of 29.7 per 1000 connections an increase of approximately 100%.

Of course, in addition to the number of reported breaks in 2010, there were still a significant number of breaks, which required being located through active leakage control.

Is IWS an effective drought / water conservation measure?

Further evidence from the case study substantiating the increase in leakage due to the intermittent supply regime is given in [Table 18.2.2](#) which provides data on System Input Volume and corresponding Customer Consumption. The Table shows that there was an increase of 12.8% in the System Input

Table 18.2.2 System input volume vs customer consumption

Year	System Input Volume	Customer Consumption
2007	Base line	Base line
Before Intermittent Supply	0%	0%
2008	-17,5%	-9,2%
Intermittent Supply		
2009	-9,1%	-8,9%
Intermittent Supply		
2010	+12,8%	-1,2%
After Intermittent Supply		

Volume in the year immediately after the lifting of the IWS regime compared to the base year immediately prior to IWS. This increase could in fact be attributed to either increase in customer consumption or increase in leakage or both. In fact from the data examined the customer consumption was slightly less (1.2%) compared to the year before the intermittent supply measures were applied which clearly indicates that the additional volume in System Input Volume is attributed to leakage. It is also evident from Table 18.2.2 that the System Input Volume in the first year of intermittent supply decreased by 17.5% whereas in the second year by 9.1% indicating that the number of breaks in the network increased during the second year resulting in less water being saved. This is substantiated by the fact that the reduction in the customer consumption remained effectively the same for the two years' of intermittent supply, -9.2% in 2008 and -8.9% in 2009.

The challenge

While it is relatively easy to turn a 24/7 system to an intermittent supply, it is very hard to do the opposite. Water utilities that have fallen into the vicious cycle of IWS have major institutional, technical and financial issues and would definitely need to go through a reform process; moving to continuous supply requires often very difficult political and institutional choices that many water utilities/governments prove reluctant to make. A paradigm shift is therefore imperative to transition from IWS to 24/7 supply.

In order to improve operational, commercial and institutional efficiency the water utilities will need to strive towards reducing their water losses in the first instance coupled with an increase in the hours and days of supply until continuous supply conditions are achieved. A final step in this process once low water loss levels with continuous supply are achieved is to reduce and sustain the level of water losses to an economic level.

The need for a standardized approach

Before the first edition the IWA manual of Performance Indicators (Alegre et al., 2000) was published, there was no international attempt to standardize the water balance and water loss performance indicators. The IWA water balance and water loss PIs have meanwhile become international standard and are promoted by many regional and national professional associations around the world (including AWWA).

It is well known that expressing water losses (or NRW) in percentage of system input is misleading in the best case and doesn't work at all in IWS situation (No wonder that percentage water loss can be low if a utility has only a few hours water supply per day).

Water loss performance indicators, for example physical losses in litres/connection/day, always need to be adjusted to continuous supply (the acronym used is "w.s.p." – "when the system is pressurized").

For example: When in a system with 10 000 service connections and IWS of 4h/day physical losses are 3 000 m³/d the correct performance indicator would be:

- $3,000 \text{ m}^3/\text{d} / 10\,000 \text{ connections} = 0.3 \text{ m}^3/\text{conn.}/\text{d}$ (300 l/conn./d)
- $300 \text{ l/conn.}/\text{d} / 4\text{h} \times 24\text{h} = 1,800 \text{ l/conn.}/\text{d}$ (w.s.p.)

Only with this indicator (and the average operating pressure) the level of water loss can be understood and the transformation from IWS to 24/7 planned.

In summary, the IWA water balance methodology and the IWA water loss PIs can also be used in IWS systems – IF the supply time is properly taken into account.

Once the water loss situation is properly understood, forecasts can be made how much water will be required to supply the network in its present condition on a 24/7 basis and how much will be needed after network rehabilitation.

Transitioning from IWS to 24/7 will be different depending on the type of IWS:

- If the system was designed for IWS (like most in South Asia) one needs to start with pressurizing the system 24/7 on a zone by zone or DMA by DMA basis starting from the zone or DMA closer to the water source.
- In systems where IWS was not planned but became a reality in fringe areas of the system, water loss reduction (again, zone by zone) must be started in the part of the network with best supply and highest water losses and the water saved can then be pushed to the poorly supplied areas.

Details on the use of water loss PIs under IWS conditions and recommendations for transitioning to 24/7 will be published in the upcoming book on IWS to be available through IWA Publishing in the first half of 2017.

Conclusions/Key learning points

From the data and information presented in this paper which is based on actual data from distribution networks worldwide the following conclusions/key learning can be drawn regarding the use of IWS:

- IWS can easily be adopted by the water utility but it is extremely difficult to revert to 24/7 supply due to the damage caused to the network.
- IWS may seem to be a water saving measure however in the long run greater quantities of water will be lost through increased leakage and wastage compared to the quantities that may initially be saved.
- IWS has a detrimental effect on the structural integrity of the distribution network thus leading to quicker asset deterioration.
- IWS results in a substantial increase in the number of pipe bursts in mains and service connections thus increased leakage.
- IWS could create water quality problems which may be detrimental to human health and wellbeing.
- IWS has an adverse financial effect on the water utility resulting in lower water sales and higher costs due to additional O&M activities needed to run IWS.
- IWS results in customer dissatisfaction and reluctance to pay due to poor quality of service provided.
- IWS is not considered an appropriate intervention to drought/water shortage.

REFERENCES

- Alegre H., Hirner W., Melo Baptista J. and Perena R. (2000). Performance indicators for water supply services, IWA Operations and Maintenance Committee, ISBN 1-900222-272.
- Andey S. P. and Kelkar P. S (2007). Performance of Water distribution Systems during Intermittent versus Continuous Water Supply, Journal of the American Water Works Association.
- Charalambous B. (2009). Water Crisis – Bridging the Gap. IWA ‘Water Loss 2009’ Conference Proceedings, 26–30 April 2009, Cape Town, South Africa.
- Charalambous B. (2012). The effects of Intermittent Supply on Water Distribution Systems. IWA ‘Water Loss 2012’ Conference Proceedings, 22–25 January 2012, Manila, Philippines.
- Chary S. (2009). The cost of coping with intermittent water supply in India. Presentation at the Administrative Staff College of India.
- Gottipati P. and Nanduri U. (2014). Equity in water supply in intermittent water distribution networks. *Water and Environment Journal* 28(4), 509–515.
- Jalakam A. (2014). Experiences of Intermittent Water Supply in India. Presentation at the IWA ‘Water Loss 2014’ Conference, 30 April–2 May 2014, Vienna, Austria.

- Mckenzie R. S. (2016). The Dangers Of Intermittent Supply As A Measure To Save Water In South Africa. Paper presented at the 80th Conference of The Institute of Municipal Engineering of Southern Africa (IMESA), 26–28 October 2016, East London, South Africa.
- Nielsen K. (2013). Impact Evaluation For Switching from Intermittent to 24×7 Water Supply In Hubli-Dharwad, India. Seminar at World Bank, July 25, 2013, Delhi, India.
- Totsuka N., Trifunovic N. and Vairavamoorthy K. (2004). Intermittent urban water supply under water starving situations. 30th WEDC International Conference, Vientiane, Lao PDR.

Paper 3: The problem of leakage detection on large diameter mains

Stuart Hamilton¹ and Daniel Krywyj²

¹*Hydro Tec Ltd, The Barn, Thorpe Underwood, Northampton, NN6 9PA, UK.*

E-mail: shamilton@hydrotec.co

²*JD7 Ltd, Unit 8, Masons Business Park Nottingham Rd, Derby, DE21 6YZ, UK.*

E-mail: Daniel.Krywyj@jd7.co.uk

Keywords: Acoustic, leaks, non-tethered devices, CCTV, Hz

INTRODUCTION

The authors of this paper are communicating the issues with transmission of noise created by a leak on larger diameter water mains and the issues involved with listening to such noise created by the leaks. The authors are also looking at the average frequency of leaks per km and the average losses from such leaks on large diameter mains.

Internal noise frequency from leaks on large diameter mains (greater than 500 mm) in some instances 50 m from the leak position can be as low as 1 Hz–10 Hz, a frequency that no human being regardless of sex or age can detect. For this reason the technology and associated software used today should be such as to identify if a leak is present and not merely relying if a noise can be heard or not. It has always been considered that if a noise cannot be heard then there would be no leak present. In the past this approach has been adopted using conventional and advanced acoustic leakage detection equipment. A modern internal tethered device has been adapted to do leakage detection in large diameter mains by showing CCTV, noise amplitude and frequency and yet even with this information the software graph is ignored if no sound is heard by the technician.

Acoustic noise generated at the point of a leak, regardless of pipe diameter or material, can be higher than 500 Hz, however these higher frequency noises are lost through the pipe wall and the water of the large diameter mains over distance leaving only the low frequencies 1–10 Hz; it is these lower frequencies generally below the human threshold of hearing that can travel long distances in the pipeline, sometimes several km. It is for this reason that listening for noise on fittings or correlating is not always successful. Due to these circumstances the internal leakage approach, although may be more expensive, will have a higher degree of success in locating leaks on the larger diameter mains.

Other technology is also available today to identify these extremely low frequency noises, however, some of this technology cannot locate the leak position but only identify if a leak is present or not.

Manufacturers are also seeking to find the solutions through correlators and to date some successes have been reported. The following section explains the importance of understanding the parameters involved in conducting leak detection on large diameter mains.

BACKGROUND

Human ear frequency range

The quality measurement for any noise heard is reliant on how well this noise sounds to the human ear. The human ear is extremely sensitive to noise and high volumes of noise can damage the range of hearing. This is

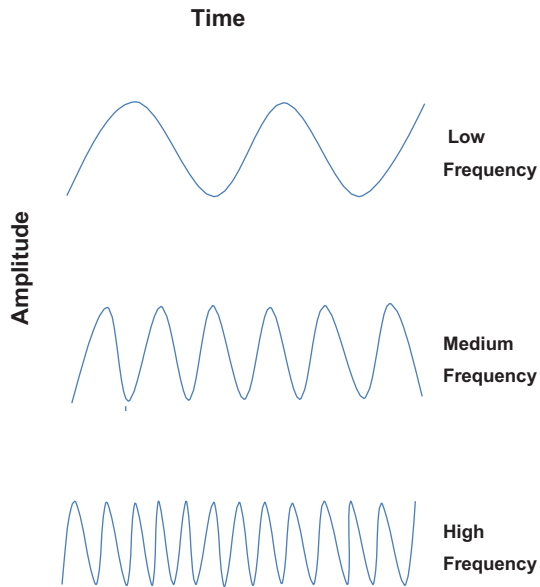

Figure 18.3.1 Example of frequency waves. (Source: Hamilton and Krywyj)

reflected in any time loud noises are listened to, as a ringing noise may be heard afterwards. This is an indication that some damage has been caused.

Hertz (Hz) is used as the measurement of the frequency of sound. For example, a low frequency sound, maybe something that is emitted from an instrument such as a large bass drum, whereas a high frequency sound would be a sound such as that which comes from a whistle (Figure 18.3.1). The Hertz sound range is different to how loud or how quiet the noise is, for instance, a loud piece of machinery or a whisper.

The human ear has an average hearing range from a low of 20 Hertz (20 Hz) to a high of 20 000 Hertz (20 kHz); but it is the most sensitive to sounds that sit between the range of 1 kHz and 4 kHz. When a person ages their hearing starts to deteriorate and by the time they reach the age of eight, the deterioration has already started. For those that during the teenage years listened to loud music or went to games with loud noises, by the age of 20 they may have already be unable to hear the high tones. Thus the hearing ability has dropped 20 000 Hertz (20 KHz) to 16 000 Hertz (16 KHz). Then by the time the age of 30 is reached, it can be such that the ability to hear the high frequencies has dropped again.

Infrasound is the term used to describe any sound less than 20Hz (i.e below the human range of hearing). Sounds above 20 kHz are known as ultrasound (i.e above the human range of hearing). Animals as well as humans, have the ability to hear over a range of frequency:

- Dogs can sense frequencies as low as 50 Hz and as high as 45 000 Hz
- Cats can hear frequencies as low as 45 Hz and as high as 85 000 Hz
- Bats, as nocturnal creatures, need to rely on sound echolocation for navigation and hunting. They can pick up frequencies as high as 120 000 Hz.
- Dolphins are extremely sensitive to frequencies and can sense them as high as 200 000 Hz.
- Elephants, have an unusual ability to detect infrasound. They have an audible range of approximately 5 Hz to 10 000 Hz.

Table 18.3.1 Number of unreported leaks per km at average 40 m pressure 2001–2011

	KM	Leaks	Leaks/Km	Leaks/100 Km
North America	1259	1056	0.84	83.88
Europe	743	924	1.24	124.36
Asia	158	94	0.59	59.49
Middle East	24	6	0.25	25.00
Totals	2184	2080	0.95	95.24

CASE STUDIES

The data shown in Tables 18.3.1 and 18.3.2 is from case studies obtained from water companies from around the world and based on validated findings of unreported leaks. These studies show where these unreported leaks have been located at different pressures, diameters and in various materials. These case studies will indicate the type of leaks located in each material along with associated noise levels. Also reported in this section will be the number of leaks per km and the average size of the leak in m³/hour.

It can be said that although many leaks have been located, not all were repaired as some were beyond economical repair, however these leaks should be regularly inspected as they are all potential catastrophic failures. To date there has not been sufficient data worked upon to identify the life of a leak and it is not known if the burst frequency/natural rate of rise calculation used in the distribution mains is applicable to the larger diameter mains however the authors suggest that recording the date of the survey and the time period measured between surveys can be used as base line data. This data against the age of the pipe will be an indicator to be used in future analysis.

LIFE OF A LEAK

Each leak has a life span and although there are technical terms available, as we are discussing the larger diameter mains the authors have at this point tried to explain them in simple terms. There are four parts to the life of a leak: weep – leak – burst – catastrophic failure.

Weep/Small loss – a small amount of water leaving a pipe from a small failure that is less than 5 litres per minute (1 imperial gallon per minute).

Leak/Medium loss – an amount of water that leaves a pipe through an orifice at an estimated flow of 90 litres per minute (20 imperial gallons per minute).

Table 18.3.2 Number of unreported leaks over mains diameter 2001–2011

Mains Dia mm	KM	Leaks	Leaks/Km	Leaks/100 Km
500	1139	1547	1.36	135.82
500–1000	987	515	0.52	52.18
1000	58	18	0.31	31.03
Totals	2184	2080	0.95	95.24

Table 18.3.3 Estimated flows from unreported leaks at an average pressure of 40 m (From over 2000 incidents) all flows in imperial gallons

Flow from a Leak	Weep	Leak	Burst	Cat. Failure
Gallons/hour	60	1200	4200	4200+
M ³ /hour	0.27	5.4	19	19+

Note: leak flow lost increases with pressure.

Burst/Large loss – an amount of water that leaves a pipe from an orifice at an estimated flow of 315 litres per minute (70 imperial gallons per minute).

Catastrophic failure – a complete rupture of the pipeline.

In the initial request for data the question was asked if any of the leaks excavated for repair had their flows measured by some method. It was reported that only some of the repairs had in fact had flows measured albeit some very crude. This data was used along with the average pressure reported as the base line to estimate the volume lost from a Weep to a Burst shown in [Table 18.3.3](#).

Further exercises have to take place to calibrate these figures as the method of measuring in many instances cannot be validated. The numbers used in [Table 18.3.3](#) have been rounded to match losses in imperial gallons.

There was then a request to categorise all other repaired leaks into the following section to give the number of leaks by type as used in [Table 18.3.4](#):

- Weep 0.27 m³/hr
- Leak 0.27–11 m³/hr;
- Burst 11 m³/hr – 27 m³/hr
- Catastrophic failure >27 m³/hr.

HZ – LEAK NOISE

It is noticeable that there is a varied range in Hz when listening to a leak noise, this can be due to many factors ranging from pipe material, pipe diameter, pressure and leak size however it can be seen that when the internal hydrophone passes the location of the leak regardless of the material of the pipe line the leak noise is greater than 300 Hz and can easily be heard by the operator. This is due to the fact that the maximum distance the internal tethered hydrophone is away from the leak is that of the pipe diameter. The leak noise in Hz drops over a distance and starts to go beneath the human range, in some instances this occurs as quickly as 30 m from the leak position. It can be seen in the figures below that when using internal tethered devices the operator hearing ability is not critical but should be a consideration. Today's

Table 18.3.4 Unreported leak categorisation

Leak Type	Weep	Leak	Burst	Cat. Failure
Total leaks identified	143	1,278	659	0

technology has software on the equipment which measures and reports these low frequency noises where as the operator may not be able to hear these.

Engineers have tried to use the frequency heard from a leak to estimate the size of the water leak. It is the authors' opinion that a leak cannot be measured as to the flow lost just by a noise measurement in Hz – there are too many other parameters which affect the range of losses.

The Figures 18.3.2–18.3.5 below show the frequency range observed over the distance measured in metres away from the various leaks.

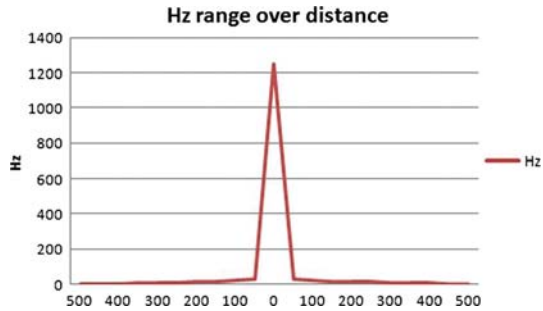

Figure 18.3.2 Noise in Hz 500 m from a leak on 300 mm cast iron pipe at 35 m pressure.

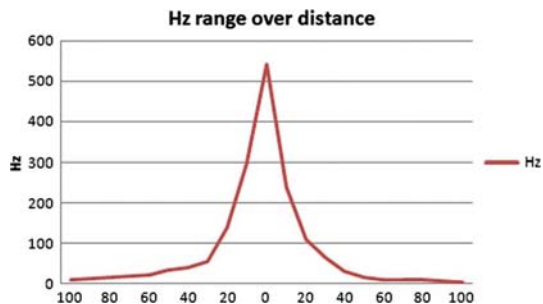

Figure 18.3.3 Noise in Hz 100 m from a leak on 500 mm cast iron pipe at 41 m pressure.

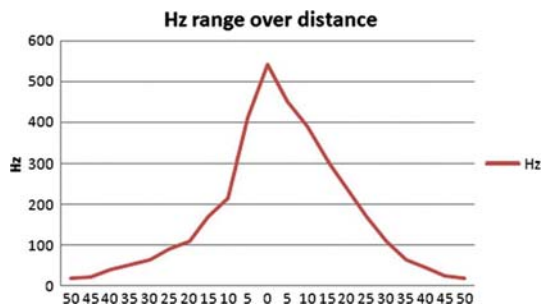

Figure 18.3.4 Noise in Hz 50 m from a leak on a 500 mm cast iron pipe at 41 m pressure.

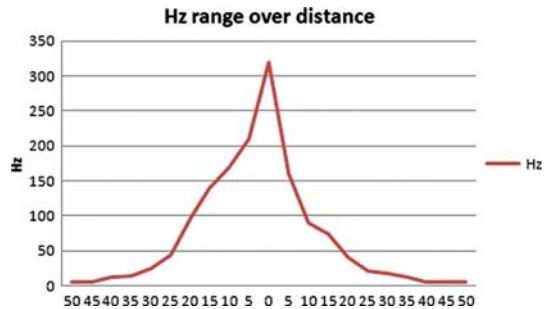

Figure 18.3.5 Noise in Hz 50 m from a leak on a 300 mm MDPE pipe 37 m pressure. (For Figures 18.3.2–5, Source: Author)

The process used was to stop the internal hydrophone at pre-determined increments prior to the leak, at the leak and after the leak to measure the noise in Hz at each point; the figures were then built from this data.

It should be noted that the leak noise changes in the frequency range depending on the material and mains diameter, it should also be noted that in Figures 18.3.3 & 18.3.4 although the figures are the same leak the frequency range changes over the time the survey was conducted and this may have been due to a pressure variation over the period.

Figures 18.3.2–18.3.5 show the leak noise in Hz when using internal an hydrophone drops below the threshold of human hearing within 40 m of the leak on metallic pipes and 25 m on MDPE pipes both with an average pressure of 35–41 m. Due to these observations it should be considered that leakage surveys are not completed on metallic mains diameter greater than 300 mm or non metallic mains regardless of diameter using traditional manual listening sticks.

If using some form of electronic listening devices as the means to identify leak noises these should be able to identify if a leak is present below the 20 Hz range of noise, if they do not have this ability then we now know that leaks may be missed (Figure 18.3.6).

This conclusion falls inside the guide lines reported by the IWA WLSG Acoustic Initiative group and the written manual ‘Leakage Detection Methodologies including ALC Matrix’ Ver. 4 January 2011.

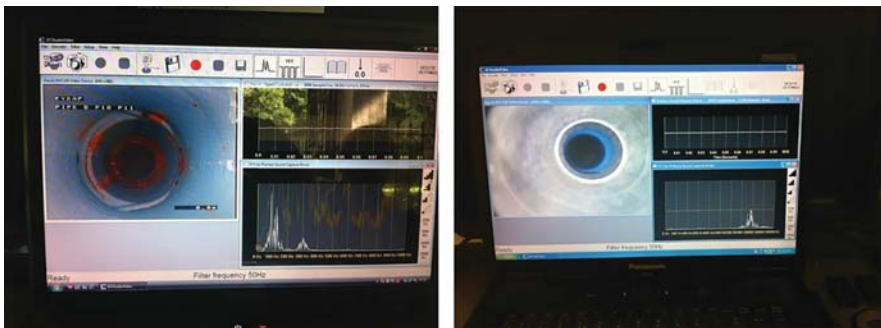

Figure 18.3.6 Screen dump from JD7 software showing of a leak inside a water pipe and the software showing the noise generated from the leak in Hz and Amplitude JD7AV software – version 1.1.0.10 developed 2012. JD7, Derby, UK. (Source: JD7 Ltd)

Table 18.3.5 Matrix is for leakage detection on all property and mains fittings with pressures greater than 10 m head or 15 psi. Fittings are at a minimum distance of 10 m apart and maximum 50 m.

Diameter	mm	75	100	150	200	250	300	350	400	450	500	600	700	800	900	1000+
	Inches	3	4	6	8	10	12	14	16	18	20	24	28	32	36	40+
Material																
Metallic all	A,B,	A,B,	A,B,	A,B,	A,B,	A,C,	A,C,	A,C,	C,D,	C,D,	C,	C,	D,E	D,E	D,E	
	C, D,	C, D,	C, D,	C, D,	C, D,	D,E,	D,E,	D,E,	E, F,	E, F,	D, E	D, E				
	F,G	F,G	F,G	F,G	F,G	F,G	F,G	F,G	G	G						
Concrete all	A,C,	A,C,	A,C,	A,D	A,D	A,D,	A,D,	A,D,	E	E	E	E	E	E	E	E
	D,F,	D,F,G	D,F,G			E	E	E								
	G															
Asbestos	A,C,	A,C,	A,C,	A,C,	A,C,	A,D,	A,D,	A,D,	E	E	E	E	E	E	E	E
Cement	D,F,	D,F,G	D,F,G	D	D	E	E	E								
	G															
GRP	A,C,	A,C,	A,C,	A,C,	A,C,	A,D,	A,D,	A,D,	E	E	E	E	E	E	E	E
	D,F,	D,F,G	D,F,G	D	D	E	E	E								
	G															
PVC	A,C,	A,C,	A,C,	A,D	A,D	A,D,	A,D,	A,D,	E	E	E	E	E	E	E	E
	D,F,	D,F,G	D,F,G			E	E	E								
	G															
Polyethylene all	A,C,	A,C,	A,C,	A,D	A,D	A,D,	A,D,	A,D,	E	E	E	E	E	E	E	E
	D,F,	D,F,G	D,F,G			E	E	E								
	G															

Notes: Method A – gas injection; Method B – traditional techniques with manual listening stick; Method C – non-intrusive acoustic techniques that is standard correlator, correlating noise loggers (accelerometers); Method D – intrusive acoustic techniques that is standard correlator or correlating noise loggers (hydrophones); Method E – inline inspection techniques (tethered & free-swimming); Method F – noise loggers (non-correlating), non-intrusive magnetic connection; Method G – electronic amplified listening ground microphone.

Table 18.3.5 shows one of the four matrices developed which show the best possible scenario and yet still does not promote manual listening on fittings for leakage surveys on any non metallic mains or metallic mains 300 mm and above.

It should also be noted that as a rule of thumb the noise frequency from a 100 mm non-metallic main has the same acoustic parameters as that of a 400 mm metallic main.

CONCLUSIONS

Conducting a manual acoustic sounding exercise on metallic pipelines 300 mm diameter and above with fitments more than 100 m apart or on any non metallic pipe work using human hearing alone is a non effective way of conducting a survey. The Hz range from a leak does not travel to the fitting high enough for the human ear to be able to hear the leak. If an electronic device has the ability to measure noise in Hz then this may be an option. On previous surveys it has been reported that listening devices

on non metallic pipes were not effective unless they were attached to access points that were close to the leak – roughly within 5 m (16 ft).

Operators using headsets attached to leak-noise correlators are on many occasions unable to hear leak sounds. The thought process currently with engineers is if no noise is heard, then no leak should exist. Operators of the correlators have been surprised to be able to locate leaks using the cross-correlation of leak sounds that they could not hear.

The authors recommend that manual sounding on fittings for leak detection purposes on non metallic mains or on metallic water mains over 300 mm in diameter should stop as the operators may not hear any leaks present and an alternative approach for this type of routine operation should be considered.

The higher Hz range from the leak is lost very quickly in the pipe wall and the water of the larger diameter pipes leaving the lower frequencies that can travel long distances – it is these lower frequencies that can be problematic to the traditional correlator. Insertion technology is successful since the acoustic head is only the maximum distance from the leak as the pipe diameter it is in that is on a 500 mm diameter pipe the acoustic sensor (hydrophone) inside the pipe when passing the leak can only be a maximum of 500 mm from the leak position.

Advancements in correlators are changing and some are beginning to show successes in locating leaks using the low frequencies over the longer distances.

The average number of leaks that have been found over the 2184 km is 95.24 per 100/km with varied results over the 4 regions the data was gathered from. Some reasons for these varied results can be the pressure within the water main. Within Europe where the average pressure is 45 m (67.5 psi) 124.3 leaks/100 km have been located where as in Asia where pressure have been as low as 3 m (5 psi) only 59.49 leaks/100 Km were found. This is slightly below what has been previously estimated at 110 leaks per 100/km and this may be due to the increase of surveys being completed in the Asia & Middle East regions. It has to be commented on that the results from Asia have been very varied with the number of leaks per km and this should be investigated to understand why the variation has occurred.

For ease the authors have divided the leaks into 4 categories with these ranging from a weep to a catastrophic failure. The numbers of leak identified within these categories were: Weeps – 143, Leaks – 1,278, Bursts – 659 and Catastrophic Failures – zero. The greatest number of leaks was found in the ‘Leak’ category however the greatest volume of water lost per hour was from the ‘Burst’ category. The number of Weeps located was found to save little water and are also the most expensive to repair, the average loss from the weep of 0.27 m³/hr is close to the current limit for background leakage (0.25 m³/hr at 50 m pressure), these events are not normally repaired if they are considered ‘beyond economic repair and become equivalent to background leakage’ but as the authors have mentioned these have to be investigated with as they will progress to a Leak. The time scale of this life has not been looked into and is unknown but with soil analysis and NDT surveys undertaken then this life expectancy can be calculated.

The findings from this paper were taken from companies throughout the world and are based on the information given at the time. The volume of water lost from these leaks has been estimated and further research has to be completed to give more accurate findings. The paper also at this time has commented on Hz range from leaks heard and further research has to be completed to identify more accurate results.

The authors would more than pleased to receive further information and/or data in this particular field in order to establish a firm base on which to build futute methodologies and strategies for dealing with leakage on large diameter mains.

ACKNOWLEDGEMENTS

Data supplied by JD7 Ltd and several water companies/consultants that wish to remain anonymous.

FURTHER READING

- Hamilton S. (2007). An Economic Active Leakage Control Policy without a Performance Indicator is not a Myth. IWA Water Loss 2007, 23rd–26th September 2007, Bucharest, Romania.
- Hunaidi O., Chu W., Wang A. and Guan W. (2000). Detecting Leaks in plastic pipes. *Journal AWWA* **92**(2), 82–94.
- IWA Water Loss Specialist Group (2011). Leakage Detection Methodologies Manual Version, 4 January 2011. IWA, London, UK.

Paper 4: Technology – How far can we go?

Stuart Hamilton¹ and Daniel Krywyj²

¹*Hydro Tec Ltd, The Barn, Thorpe Underwood, Northamptonshire, NN6 9PA, UK,
E-mail: shamilton@hydrotec.co*

²*JD7 Ltd, Unit 8, Masons Business Park Nottingham Rd, Derby, DE21 6YZ, UK
E-mail: Daniel.Krywyj@jd7.co.uk*

Keywords: Technology, Acoustic, Correlator, ALC, AMR, Pressure, Software

INTRODUCTION

The world's population is increasing at a tremendous rate, the world's renewable water resources are reducing rapidly, the gap between water supply and demand is widening with urbanisation and climate change making the gap even wider. This paper outlines the importance of technology and innovation, describes technologies available in assisting water utilities to save valuable quantities of water lost through leaky networks and highlights the way forward in developing appropriate technology.

To deal with such losses in an effective manner, particularly from networks in water scarce areas, water utility managers are increasingly turning to technology to reduce costs, increase efficiency and improve reliability. Companies that continuously invest in technology and innovation will see a positive return on investment in terms of improving daily operations and collection and analysis of network data for decision making and forward planning.

BACKGROUND

It is evident that times are changing and globalisation, information technology, innovation and sustainable development are part of our daily lives. Water utilities are considered to be extremely conservative especially when it comes to change. It has been the approach for many years that if something works do not change it. However, a number of water companies recognised the need to go forward towards a higher standard of performance.

Many water utilities are using Technology to improve reliability and to reduce costs. The need for change is becoming more and more pressing in order to facilitate and improve daily operations and to collect data for timely analysis and decision making as well as forward planning.

An important aspect that is usually debated is whether there is a positive return on investment in technology. In my opinion, there is a positive return on technology investment for companies that concentrate on enhancing system performance and focus on technological developments. This has certainly been the case with the technological changes which have taken place over the last 20 years in many water utilities around the globe. Now, is there a real need to continue developing technology to control water losses? Let us first have a look at some facts and figures:

- Currently there are 7 billion human beings on the earth and this is increasing by more than 2 people per second, 173,000 per day or 63 million per year, each extra life needs food, energy water and shelter. This rate of increase means that by the year 2050 the earth's population will be 9.5 billion human beings. Over the past 2000 years nature has controlled the earth's population. However, now with the impact of extending life by controlling diseases, the majority of today's teenagers will live until they become grandparents.

- The earth is called the blue planet because 70% of its surface area is covered by water. Only 2.5% of this water is fresh water of which just 1% is available for human consumption; the rest is locked up in glaciers and polar ice caps.
- Today more than 1 billion people lack access to safe drinking water and this will worsen.
- Predictions indicate that in the next 20 years as much as 50% of the world's population will live in areas of water stress.

Such chronic shortages are often a result of poor infrastructure, politics, poverty or simply living in an arid part of the world. For instance, one of the richest cities in the world benefits from heavy annual rainfall, it supplies 20 million inhabitants with water and yet every day at least 1 million people experience some sort of water shortage.

Therefore, it is imperative that problems of water shortage and scarcity are dealt with in an effective manner, especially in water stressed areas. Losses from water distribution networks are a major issue worldwide. It is known that water leakage varies from less than 10% of the water put into network systems in extremely good situations to greater than 60% leakage in extremely poor situations with the average NRW being 20%–30% of the system input volume.

WHAT IS TECHNOLOGY?

- Application of knowledge to the practical aims
- Changing and manipulating the way we think
- Includes the use of materials, tools and techniques to make life easier, more pleasant, increase productivity and to ensure that the problem that was impossible becomes possible.
- Technology began to influence human endeavor as soon as people began using tools.

It is evident that technology has an important role to play in order to deal efficiently and effectively with these high volume losses. So, where do we start and what do we have available? Well the very short answer is that technology is not moving fast enough to deal with these problems.

Methodologies are continuously changing to enable the best results to be achieved in the reduction of water losses. It is therefore imperative to move away from stock markets and profit making and to invest in the research and development of technology. Water companies and equipment manufacturers must work together in an effort to push current knowledge boundaries and to come up with improved and new ideas in order to complement current methodologies and together to provide solutions to reduce losses (Figure 18.4.1).



Figure 18.4.1 The continuous loop for product development. (Source: Author)

Some countries do encourage research to be carried out through government funded projects but this is nowhere near enough to meet the ever increasing challenges that we are currently facing. What is currently available and what is new to help combat the situation?

The IWA Water Loss Specialist Group identified the following methodologies which reduce real losses (leakages) as well as restrict apparent losses (increase revenues).

The methodologies for reducing Real Losses (leakages) are: Active Leakage Control, Pressure Management, Speed and Quality of Repairs and Renewal of Pipelines. Typical technology which is available in each one of these areas is briefly described below.

ACTIVE LEAKAGE CONTROL

Recent advances in equipment to help with location of leaks include correlating noise loggers, digital leak noise correlators with three sensors for better leak positioning and a ground microphone that can prioritise leaks by size and internal acoustic sensors for large diameter pipelines.

Internal tethered pipe technology is such that a cable can be inserted through a fire hydrant which has a head attached to the end. Within this head is a camera, hydrophone and location sonde. This system can go with or against the flow and has a maximum current range of 100 m, the ability here is to see the leak, hear the leak and to locate the head to pinpoint the position of the area of interest. This technology on the 300 mm and smaller metallic mains does not replace the traditional correlator however on the non metallic mains it has distinct advantages. This technology is used for internal condition pipe assessment showing tuberculation, unknown laterals, blockages and many other conditions. There is also a long range tethered technology available which can go distances currently up to 2000 m also the head combines a camera, hydrophone and location sonde. A company is in the process of attaching an ultra sonic internal condition assessment and pipe wall thickness measurement tool to the same head so it becomes a quadruple head.

Non-tethered devices range from a ball that rolls down the main locating leaks as it passes them, this device is captured by a net and retrieved from the main, this technology is restricted to 300 mm diameter pipe work and above. A completely new device available to the market in 2012 is a small 3 cm×10 cm bullet shaped device which can be launched in a 75 mm and above diameter pipe work and contains a camera and hydrophone. This device can be launched through a fitting on the main or a through bore fire hydrant. This device can be retrieved if it is attached to a tethered braid or can be launched as a free swimming device and captured somewhere down stream in the water main.

A robot is being designed and will be in commission during the next 24 months and this will live in the water main reporting on leaks as they occur and may have the ability to repair the water leak from inside the main with some sort of sealant it carries with it.

Other non acoustic technologies to assist in the location of leaks in the distribution system are being developed. One of these is software to localise leak positions using pressure drops and pressure variants in the network to locate the leak positions. Another uses statistical analysis of past data to try to calculate when and where a leak will occur next.

Another new technology is a system that measures flows through either permanent or temporary flow meters in the distribution system to identify the area where an increase in flow has occurred, indicating a potential leak. Acoustic devices can be attached to the meter to help locate the leak position.

There are several European Union co – funded research projects on technology currently in progress – with varying results and successes. Two such projects that have now been completed are ‘*Waterpipe*’ and ‘*Leaking*’. The projects have similar objectives – to provide a non-intrusive leak location technology.

WATERPIPE

'*Waterpipe*' is a *system* where the leak is located by ground penetrating imaging radar. The objectives of the project were to investigate and develop a high resolution imaging ground penetrating radar for the detection of pipes, leaks and damages to underground infrastructure – and to provide imaging of the damaged region. A further enhancement was to produce an integrated system that will contain both the GPIR equipment and a Decision-Support-System (DSS) for the rehabilitation management of the underground water pipelines. This would use input from the inspections to assess, probabilistically, the time-dependent leakage and structural reliability of the pipelines and a risk-based methodology for rehabilitation

decisions that considers the overall risk, financial, social and environmental criteria.

Please see [Bimpas *et al.* \(2010\)](#) for the findings from 'Waterpipe' project.

LEAKING

'*Leaking*' had objectives to investigate and develop an innovative leak inspection equipment for water pipelines based on microwave technology (a Continuous Wave Doppler radar, a Frequency Modulated Continuous Wave radar and a radiometer), and a decision support system, that stores available data on the pipe network, and receives input from leak inspections. It should be able to perform condition assessment to determine residual life time of the pipeline in question.

There are many other internationally funded projects – all of them are trying to achieve the breakthrough that would change the way Active Leakage Control is currently carried out. These initiatives are funded by Governments, universities, manufacturers, partnerships and water companies.

The author considers that not enough initiatives are undertaken or sufficient emphasis is given to reach a breakthrough which eventually will happen but unfortunately seems not to be on the horizon at the moment but with continuous research and development it could happen at any time.

The findings from 'Leaking' project will be available some time in 2010.

PRESSURE MANAGEMENT

The use of pressure reducing valves is always investigated with regard to obtaining the best possible results. Current pressure control techniques available are Flow/Time Modulation, Multi Point Control (flow or pressure), Critical Point Control (real time or through self learning algorithms) all of which provide solutions to problems of excess or varying pressure thus reducing losses.

New ideas in this field are available, one of which is using advanced programming to regulate the pressure valve thus always maintaining the required pressure at the control points, thus saving water above that of the traditional pressure valve operation.

SPEED AND QUALITY OF REPAIRS

An idea that is currently being investigated is that of self repairing pipes or self healing pipes. The pipe repairs itself from the inside using small particles or chemicals that are induced into the pipeline. Other similar ideas, such as when a leak occurs on the water main to send a report to a control station notifying the water company of the leak and its position are also looked into.

At the moment there are only a handful of cities in the world which have invested in such equipment, other cities failing to do so normally use the high investment cost as the reason.

RENEWAL OF PIPELINES

A perfect solution to leakage would be a pipe that doesn't leak. The pipes used today are designed to last 50+ years and be leak free; however, there is a major problem in that any joint that requires any sort of human intervention is unfortunately a source of a potential leak.

The question is often asked: 'Why hasn't the industry developed a pipe that is leak-free'? Many companies are in fact addressing this question - pipelines that are better protected against corrosion and at keeping the water clean.

Other investigations deal with the insertion of sensors either constructed in the pipe or alongside the pipe others are where a fibre optic cable is laid alongside the pipe reporting on changes to noise/temperature conditions all of which report back to a central computer when a leak occurs. This technology has to be introduced during the renewal of the pipeline, the major issue being that investment will be made in a system to locate water leaks on a pipe line that is designed to last for 50+ years. But this should not be the reason to reject such ideas - if the pipe fails for any reason prior to the end of its life of the pipe this will also be identified.

METHODOLOGIES IN REDUCING APPARENT LOSSES

Methodologies in reducing Apparent Losses thus increasing water utility revenues have been developed. Technologies to accurately measure water consumption and to reduce under-registration have recently been introduced and provide cost effective solutions.

METER ERROR – METER UNDER REGISTRATION

The under registration of flows through a water meter is a source of revenue lost by the utility and many companies have developed and produced devices that allow very small flows to be recorded, meters that measure low flows and meters that have no moving parts. Other devices are available that can be added to an existing meter to allow for extremely low flows to be measured.

AUTOMATIC METER READING

AMR is a way for the utility to read customer meters on a daily basis, sometimes continuously, allowing revenue to be collected using more frequent billing cycles. The company can also have a clear picture of the consumption by the household and indentify when a meter stops. This could indicate that the meter is broken or, for example, that a sole occupier is unwell. Conversely a higher than normal reading could indicate a leak on the service pipe.

Current technology allows transfer of data from the water meter by 'fixed radio network' or while a meter reader walks or drives past the meter. Software is available to produce a bill which is delivered by the utility employee while at the property.

One manufacturer has recently produced a drone aircraft that allows meters to be downloaded in remote locations by flying over the water meter. Noise loggers combined with water meters to allow both the meter flows and potential leaks being downloaded daily is another recent introduction.

SOFTWARE

In the area of water distribution network management advanced communication systems and software applications are playing an extremely important role in being able to take informed decisions timely and accurately.

Data Storage and Communication

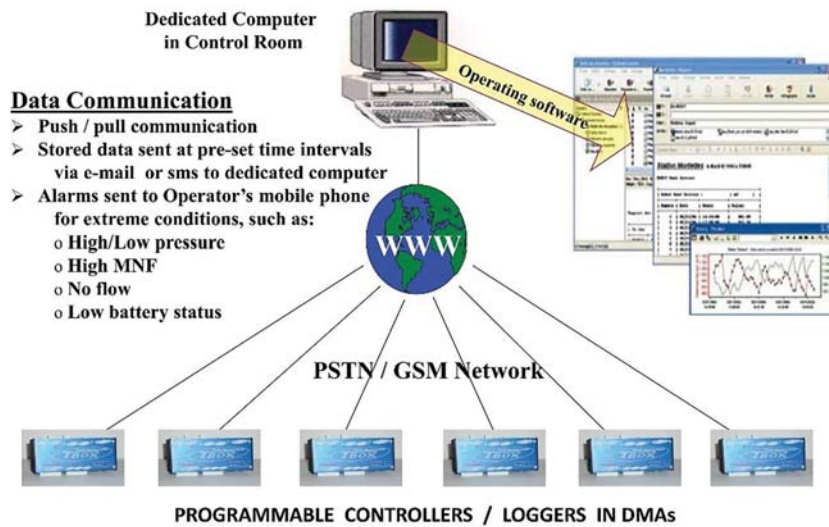

Figure 18.4.2 Typical set up for transfer of data collected and stored on critical site locations. (Source: Author)

COMMUNICATION SYSTEMS

The current trend is to apply solutions which combine information technology and telecommunications networks using the World Wide Web or GSM networks for the transfer of data which is obtained from site devices, such as water meters, pressures sensors, and so on.

Careful consideration and examination of the available technologies must be given in order to adopt an appropriate system with low capital expenditure as well as low operational and maintenance cost. A typical communication system for the storage and transfer of valuable information is shown diagrammatically in [Figure 18.4.2](#) providing all the necessary information for the efficient and effective management of a water supply system.

SOFTWARE APPLICATIONS

Operating software provides an intelligent communication interface between the monitoring stations and the central control which exploit the power of the internet by receiving data from the monitoring stations and has the capability of transferring and exporting data to the majority of data bases. Most software incorporates powerful graphics to display data in the form of graphs and statistical tables as well as to Geographical Information Systems for further analysis.

The pressing need to efficiently manage water distribution networks has highlighted the need to develop software tools that would assist in the integrated and automated management of the networks. Such asset management tools should assist the network owners to evaluate the condition of the water distribution network, assess historical incident data (leakage or breakage) and risk of failure, visualise areas of high risk, propose “repair or replace” strategies and prioritise the work based on the inherent risk and cost of action.

The risk assessment and management (“repair or replace”) system is based on analytical and numerical modelling techniques and supplemented with geographical distribution systems (GIS). The goal is to enable

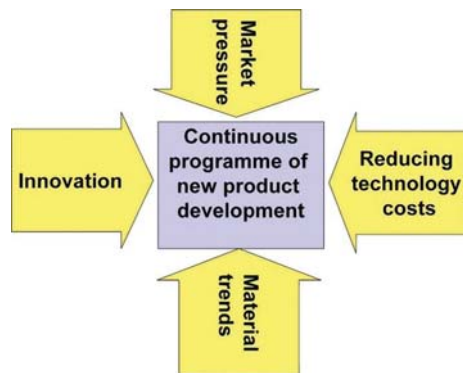

Figure 18.4.3 The four drivers on the manufacturer. (Source: Author)

water utilities to better manage condition assessment information, to process historical records with a number of analytical and numerical models, to identify underlying data patterns with artificial intelligence techniques and eventually to assess the corresponding risk of failure of each network element and to visually disseminate this information via geographical information systems.

INNOVATION IN THE FUTURE – CONCLUSIONS

The prime drivers needed for a continuous programme of new product development are shown diagrammatically in [Figure 18.4.3](#). There is a market demand for new and improved technologies at affordable prices, but innovation and new products must be capable of delivering results in a cost efficient way. For this to happen a joint effort is needed by utilities, manufacturers, and researchers to develop the next generation of technology for the water utilities.

It is felt by the author that governments should encourage such investigations using grants and that water companies should be willing to partner with manufacturers to design the solution to the water loss problem. The water scarcity issue is getting no better and we cannot afford to wait much longer to start to look for solutions.

It is illuminating to consider how far technology has moved forward in the past 10 years in one particular field – mobile telephones. Nowadays there are options for sound, vision, SMS, MMS, E-mail, internet, camera and radio – all of these in a small hand held device. These enhancements were developed to meet a market demand, but were also fuelled by competition. It is this competition and forward driven thinking that is required in the water industry.

All stakeholders should be willing to invest in solutions today – ‘thinking outside the box’ is an apt expression for moving forward with innovative technology for saving precious water in today’s water scarce climate.

If we choose to cooperate can our intelligence and technology save us? It has to and we should be willing today to invest in the solution not wait for others to develop it tomorrow.

FURTHER READING

Bimpas M., Amditis A. and Uzunoglu N. (2010). Integrated High Resolution Imaging Radar and Decision Support System for the Rehabilitation of WATER PIPELINES. IWA Publishing, London.

- Kiss G., Koncz K. and Melinte C. (2007). Water pipe project – an innovative high resolution ground penetrating radar (GPIR) for detecting water leaks and a decision support system (DSS) for the rehabilitation management of pipelines. *Water Loss 2007 Conference Proceedings, Bucharest, Romania, 23rd–26th September, Volume 3*, 621–631.
- Hamilton S. (2005). Summary of conference proceedings, IWA ‘Leakage 2005’ Conference, Halifax, Nova Scotia, Canada, 12–14 September 2005.
- Hamilton S. (2007a). An economic active leakage control policy without a performance indicator is not a myth. *Water Loss 2007 Conference Proceedings, Bucharest, Romania, 23rd–26th September, Volume 3*, 752–762.
- Hamilton S. (2007b). Acoustic principals in water loss management. *Water 21*, **9**(5), 47–48.
- Hamilton S., Charalambous B. and Farley M. (2010) Technology: an integral part of water loss reduction. *Water 21*, **12**(1), 44–45.
- Hamilton S. and Hartley D. (2008). Misconceptions around acoustic leakage detection. *Water 21*, **10**(4), 54–56.

Ageing infrastructure and declining water resources are major concerns with a growing global population. Controlling water loss has therefore become a priority for water utilities around the world. In order to improve their efficiencies, water utilities need to apply good practice in leak detection.

To deal with losses in an effective manner, particularly from networks in water-scarce areas, water utility managers are increasingly turning to technology to reduce costs, increase efficiency and improve reliability. Companies that continuously invest in technology and innovation should see a positive return on investment in terms of improving daily operations and collection and analysis of network data for decision-making and forward planning.

Methodologies for achieving the best results to reduce water losses are continuously evolving. Water utilities and equipment manufacturers are increasingly working together to stretch the boundaries of current knowledge. This is leading to some innovative technologies and new product development to complement current methodologies. This book reflects the situation at the time of publication.

This second edition of the book updates practices and technologies that have been introduced or further developed in recent years in leakage detection. It outlines recent advancements in technology used, such as satellite aided methods in leak location, pipeline inspection with thermal diagnostics, inspection of pipelines by air using infra-red or thermal imaging cameras, drones for leak detection activities and even sniffer dogs. In addition, it is enriched with new case studies that provide useful examples of practical applications of several leak detection practices and technologies.



iwapublishing.com

[@IWAPublishing](https://twitter.com/IWAPublishing)

ISBN: 9781789060843 (paperback)

ISBN: 9781789060850 (eBook)

ISBN: 9781789060867 (ePub)

