

Pedestrian Maintenance of Traffic Hierarchy

Herbert Davis, INDOT Highway Design
Katherine Smutzer, INDOT Work Zone Safety

Take Away

- The safe accommodation of pedestrians through or around the construction zone should be addressed early in project development. **See Chapter 14. Stage 2 MOT should be complete (DM 21-08)**
- Pedestrian volume is not a prevailing consideration for the use of pedestrian maintenance of traffic.
- If the pedestrian access route is closed for construction, an alternate pedestrian route must be provided. Where it can not be provided, approval must be received from the INDOT Technical Advisory Committee (TAC).
- There is a hierarchy to follow when determining pedestrian MOT.

IMUTCD

Indiana Manual for Uniform Traffic Control Devices(Section 6D.01, 04 & 07 item C.)

“If the TTC zone affects the movement of pedestrians, adequate pedestrian access and walkways shall be provided. If the TTC zone affects an accessible and detectable pedestrian facility, the accessibility and detectability shall be maintained along the alternate pedestrian route.”

“Pedestrians should be provided with a convenient and accessible path that replicates as nearly as practical the most desirable characteristics of the existing sidewalk or footpath.”

These are the statement that the INDOT Technical Advisory Committee (TAC) is using to set criteria and a hierarchy to follow when designing pedestrian maintenance of traffic.

Goat Path

- Is a temporary par required for construction of this corner? Yes because it use to be a sidewalk and is still a PAR for able body individuals. Remember the temporary Par only has to match the existing PAR being detoured. In this case the crossing could be directed through the grass buffer so long as the running slope matches or is flatter then existing. In this case we would suggest temporary pedestrian channelizers and a matt system. 298 Fenton Ave, Indianapolis, Indiana.



Where to Start with Pedestrian MOT

Alternate Pedestrian Route Hierarchy

1. Diversion
 - a. Right-of-Way Side
 - b. Street Side
2. Detour
 - a. Midblock Crossing
 - b. Short Detour
 - c. Long Detour with Closure Time Restriction
3. Closure Time Restriction ONLY (2-3 days)

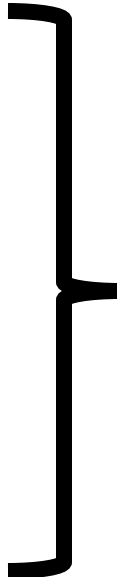

This presentation will focus on the first two schemes

Where to Start with Pedestrian MOT

Alternate Pedestrian Route Hierarchy

1. **Diversion**
 - a. **Right-of-Way Side**
 - b. **Street Side**
2. Detour
 - a. Midblock Crossing
 - b. Short Detour
 - c. Long Detour with Closure Time Restriction
3. Closure Time Restriction ONLY

This presentation will focus on the first two schemes

Diversion

- A Diversion keeps pedestrians closer to their normal route, is more convenient, and more likely to be used.



Diversion

- A Diversion can be located on the
 - Right-of-Way side of a Sidewalk (Preferred)

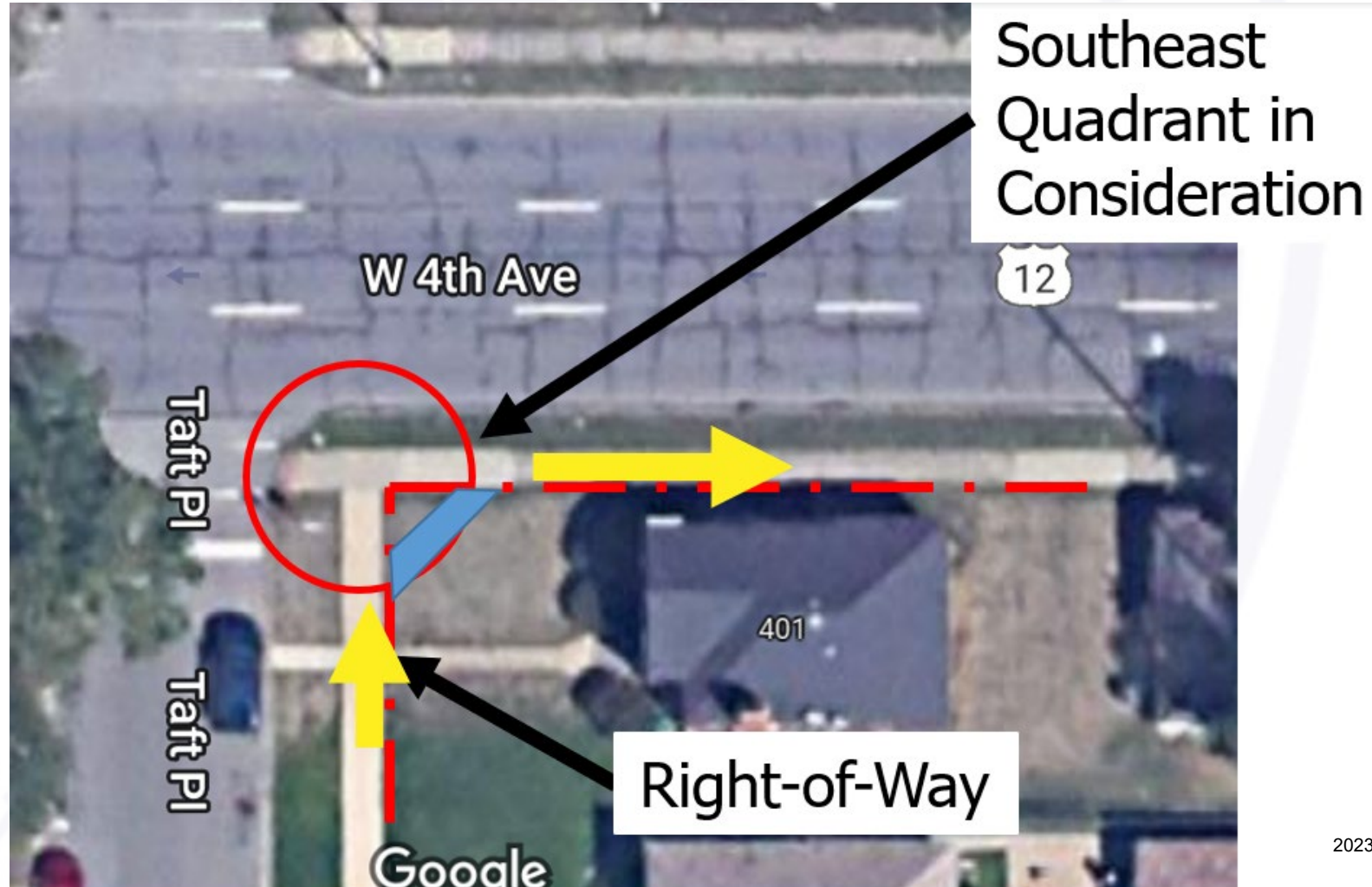

Diversion

- A Diversion can be located on the
 - Right-of-Way side of a Sidewalk (Preferred)
 - Right-of-Way Side Diversions are Preferred
 - Keeps pedestrians farther from traffic
 - Reduces possible conflicts with construction traffic
 - Right-of-Way Side Diversion Concerns
 - Width of Right-of-Way
 - Is the Surface level and stable.

Diversion

- Right-of-Way Side Diversion Example

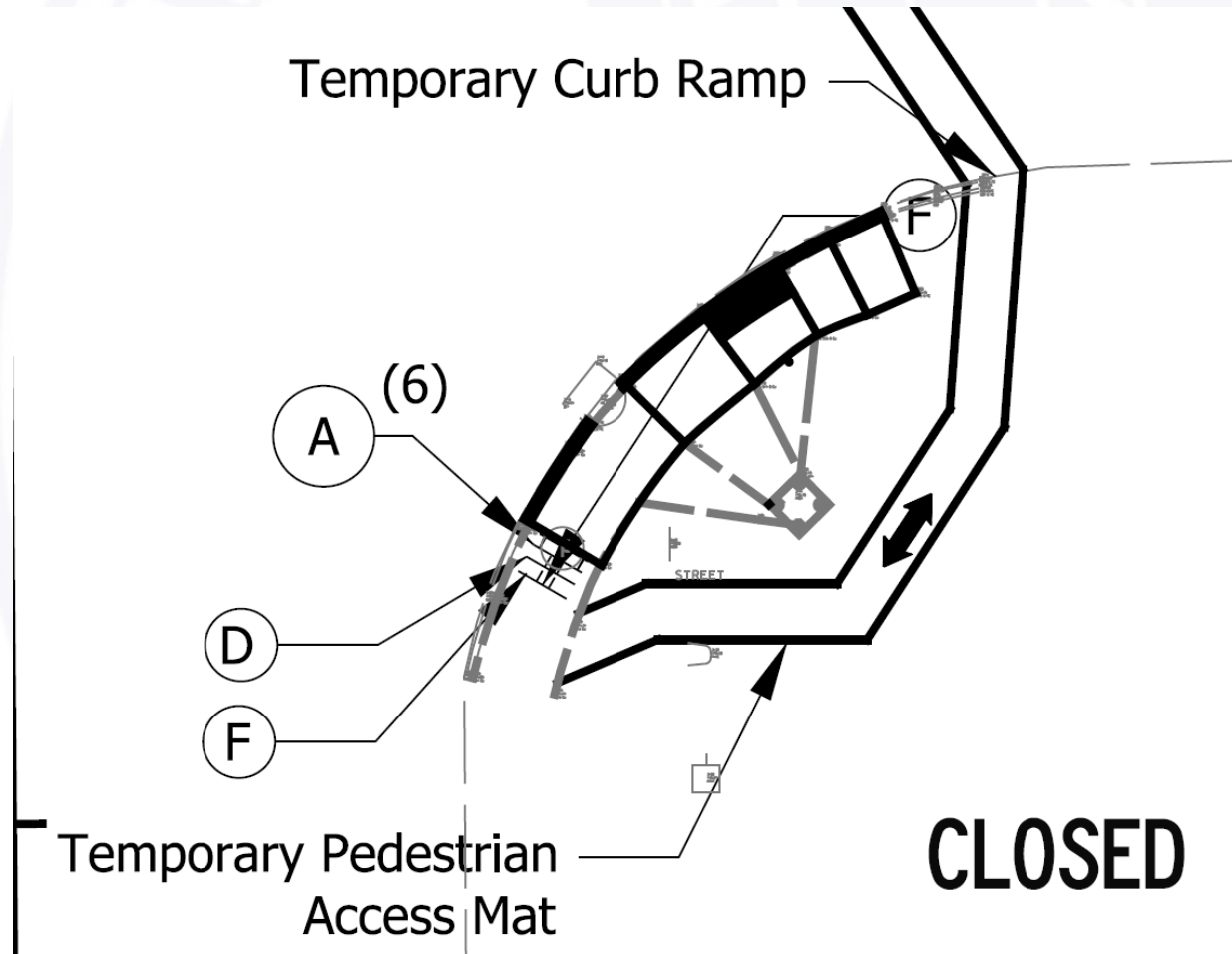

- Plan detail of a diversion.
- USP called for not disturbing the existing vegetation.

Diversion

- Diversion Example



Actual location of the diversion.

- We had the right-way
- Extra work needed to be completed on the design side to make this diversion work.
 - Wording the USP needed to include grading and a temp. pipe (there is a ditch within the tall grass)
 - Environmental Study would need to include work done outside the sidewalk

Diversion

- A Diversion can be located on the
 - Street Side of a Sidewalk



Diversion

- A Diversion can be located on the
 - Street Side of a Sidewalk
 - Street Side Diversion Types
 - Within a Buffer Strip (Preferred)
 - Within a Parking Lane
 - Within a Shoulder
 - Within a Street Lane
 - Street Side Diversion Concerns
 - Has more potential for conflict between Pedestrians, vehicular traffic, and Construction Traffic)
 - Short duration closures (less than 1 hours) may be required to complete construction, e.g. cross the PAR with the concrete chut. A pedestrian flagger may be required to direct pedestrian traffic.
 - Pushing shoulder traffic into street lanes, e.g., horse buggies or a bicycles.
 - Restricting street level of service (LOS).

Diversion

- Layout of a Diversion (IMUTCD 6D.01)
 - The Diversion should replicate the existing pedestrian access route being detoured, if not better.
 - Running Slopes
 - Cross Slopes
 - Etc.
 - The surface must be firm, stable, and slip resistant. This can be accomplished with:
 - Temporary Pedestrian Surfaces, e.g. prefabricated mats. INDOT is currently working on a Qualified Products List (QPL) and Recurring Special Provision for these surfaces.
 - Aggregate, that must be maintained throughout its use to keep it firm, stable, level and slip resistant.
 - In possible long-term projects, bituminous and concrete could also be used.
 - The temporary pedestrian access route and sidewalk closure shall be detectable to users of long canes (IMUTCD 6D.01 and 6F.74) and visible to pedestrians with vision disabilities.
 - Change in surface type, e.g. surface edged in grass or aggregate
 - Cane detectable panel, lumber or pedestrian channelizer (Unique Special Provision)
 - No more than 2 inches above the surface of the temporary PAR,
 - Extend at least 8 inches above the surface, and
 - Be continuous with no gaps.

Diversion

- When laying out a diversion
 - Consider how much width will be required.
 - Can a minimum of 4 ft be provided for a temporary PAR
 - Will pedestrian channelizers be needed for a detectable edge/ hand-trailing edge (read IMUTCD??), for one or both sides of the route or can grass be used on one or both sides (Channelizers widths have been assume to be about 1.5 ft in width each)
 - Will temporary traffic barrier be needed
 - Consider the terrain
 - Is the surface level or match the cross slope of the existing pedestrian access route
 - Is the surface firm, stable, and slip resistant, i.e. is it a parking lot or grass
 - Is there a ditch
 - Street-side diversions may also include the use of a shoulder or travel lane. The use of these areas would require coordination with the District Traffic Engineer and level of service (LOS) calculations.

When placing pedestrians in a shoulder or travel lane you do not want to create a hazardous condition for the motorists. Example in some areas of Indiana shoulders are used for horse buggies. We do not want to have to push these slower-moving vehicles into faster traffic. Waivers to close the sidewalk could be given in these areas to prevent the hazard if there are no other options.

Where to Start with Pedestrian MOT

Alternate Pedestrian Route Hierarchy

1. Diversion
 - a. Right-of-Way Side
 - b. Street Side
 2. Detour
 - a. Midblock Crossing
 - b. Short Detour
 - c. Long Detour with Closure Time Restriction
- Closure Time Restriction ONLY (2-3 days)

This presentation will focus on the first two schemes

Detour

- Where a Diversion Cannot be Provide or Provided for All Directions of Pedestrian Travel, Detours May be Use In-Lieu-of or in conjunction with a Diversion.

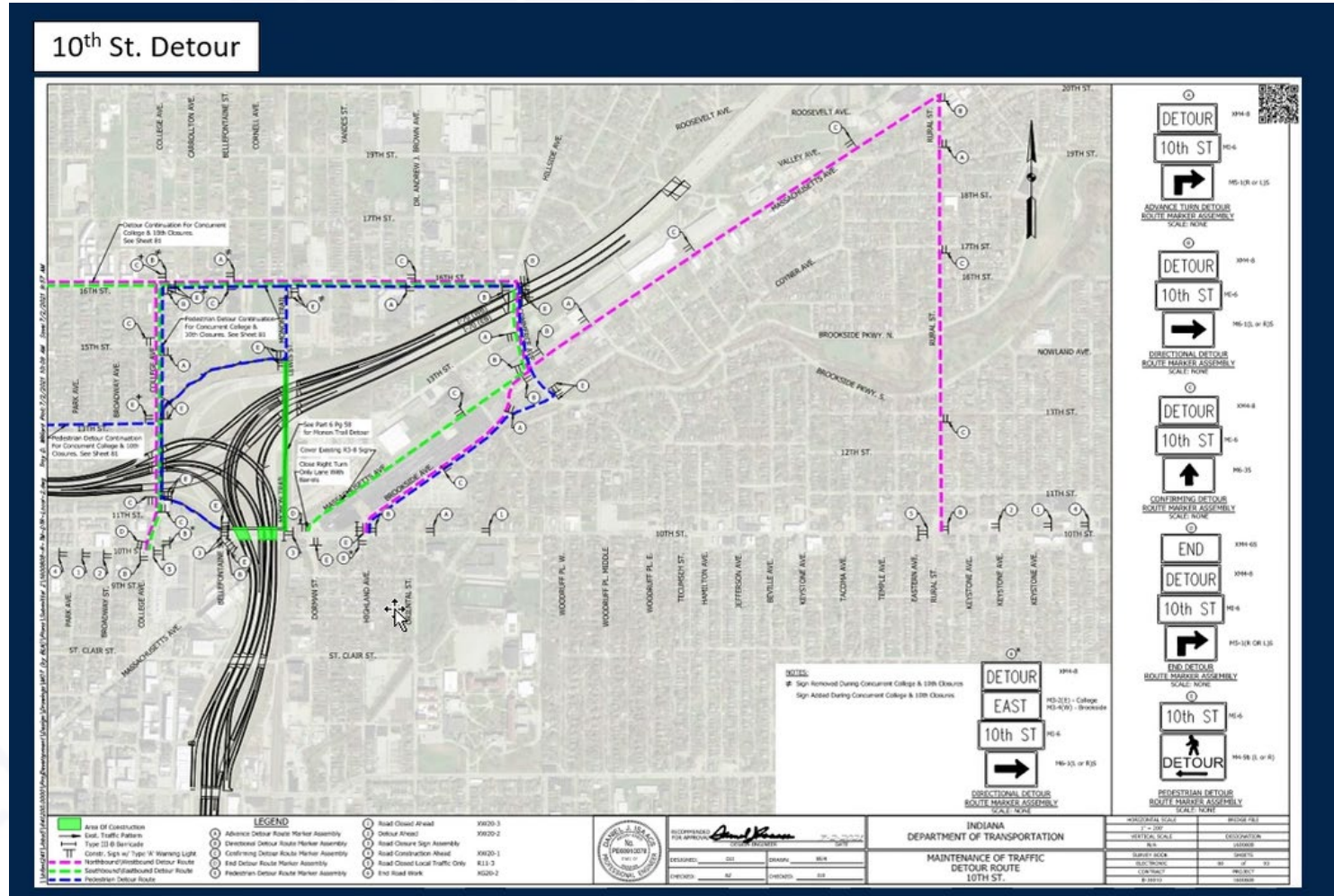

Detour

- If a diversion can not be provided a midblock crossing could be the first detour considered
- Coordinate with District Traffic to Determine a good location
- Follow IMUTCD Figure 6H-29

Figure 6H-29. Crosswalk Closures and Pedestrian Detours (TA-29)

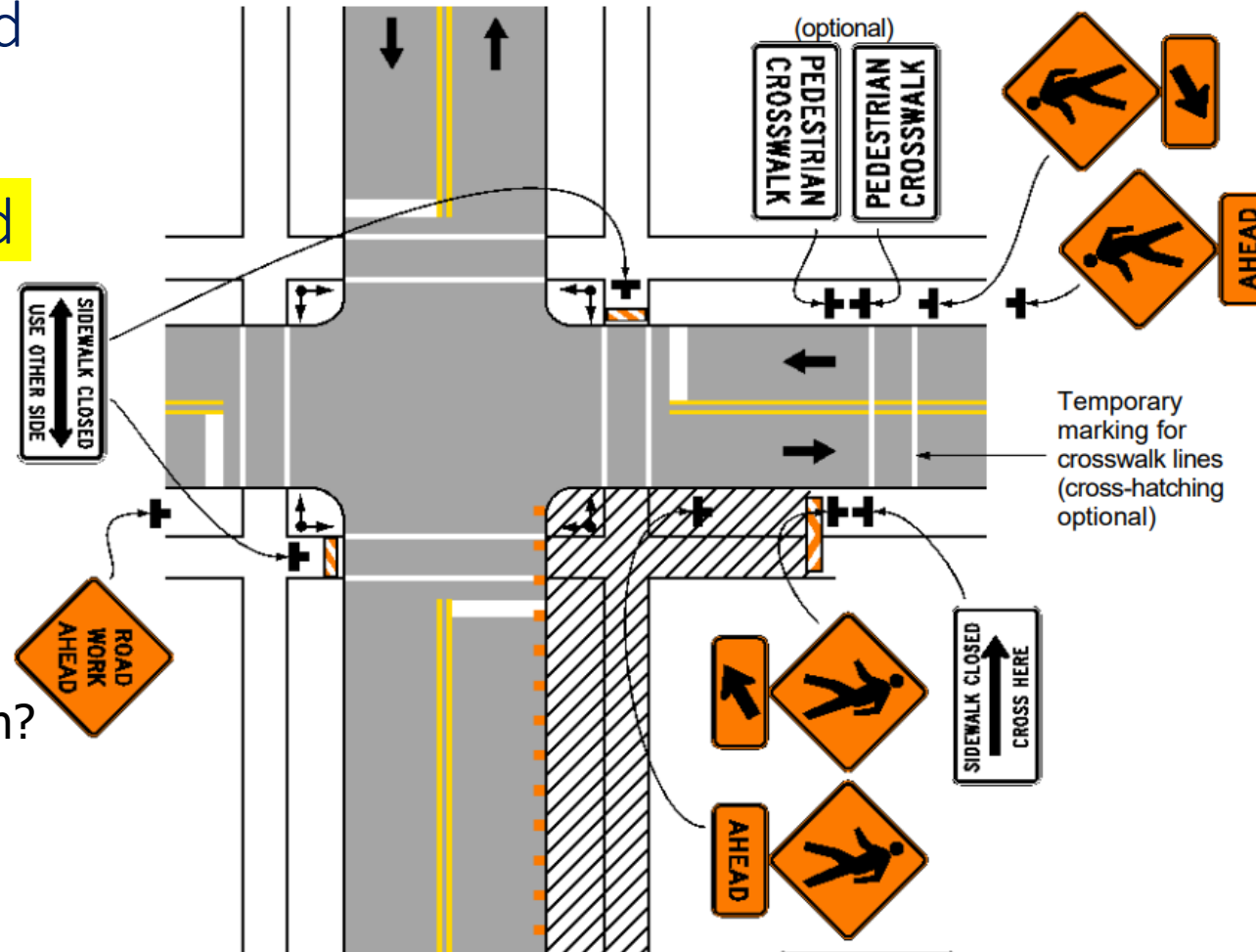

Do not forget to read the notes. If a midblock crossing is within parking lanes.
#1 **Curb Parking shall be prohibited for at least 50 ft in advance of the midblock crossing.**

A question was asked at the previous presentation, would an engineering study be needed to implement a temporary midblock crossing. After talking to one of the INDOT District Traffic Engineers, a full study may not be required, however some analysis should be preformed, for example gap analysis and sight distance to name a couple the designer may be requested to review and document a chosen location. Again always coordinate with the District Traffic Engineer.

Why not look at Midblock Crossing before a Diversion?
The answer is, traffic is accustomed to the pedestrian crossing at the street intersection.

Detour

- Where a Detour is Required
 - The shortest detour should be provided.
 - Where a short detour can not be provided, a long detour with a short-term closure, to be stipulated within the contract through a USP, must be approved by the INDOT TAC.
- The Age-Old Question????

**What is a short
Detour?????**

Detour

- Short Detour
 - INDOT TAC is working with INDOT Traffic to define a short detour.
 - Currently the proposed definition for a short detour is, no greater than one block.
 - Note some blocks are larger than others, Engineering Judgement and knowledge of the area, should be used to determine if one block, in certain situations could be considered too long.

Definition of a Block = an area of land surrounded by four streets in a city.

Detour

- Short Detour

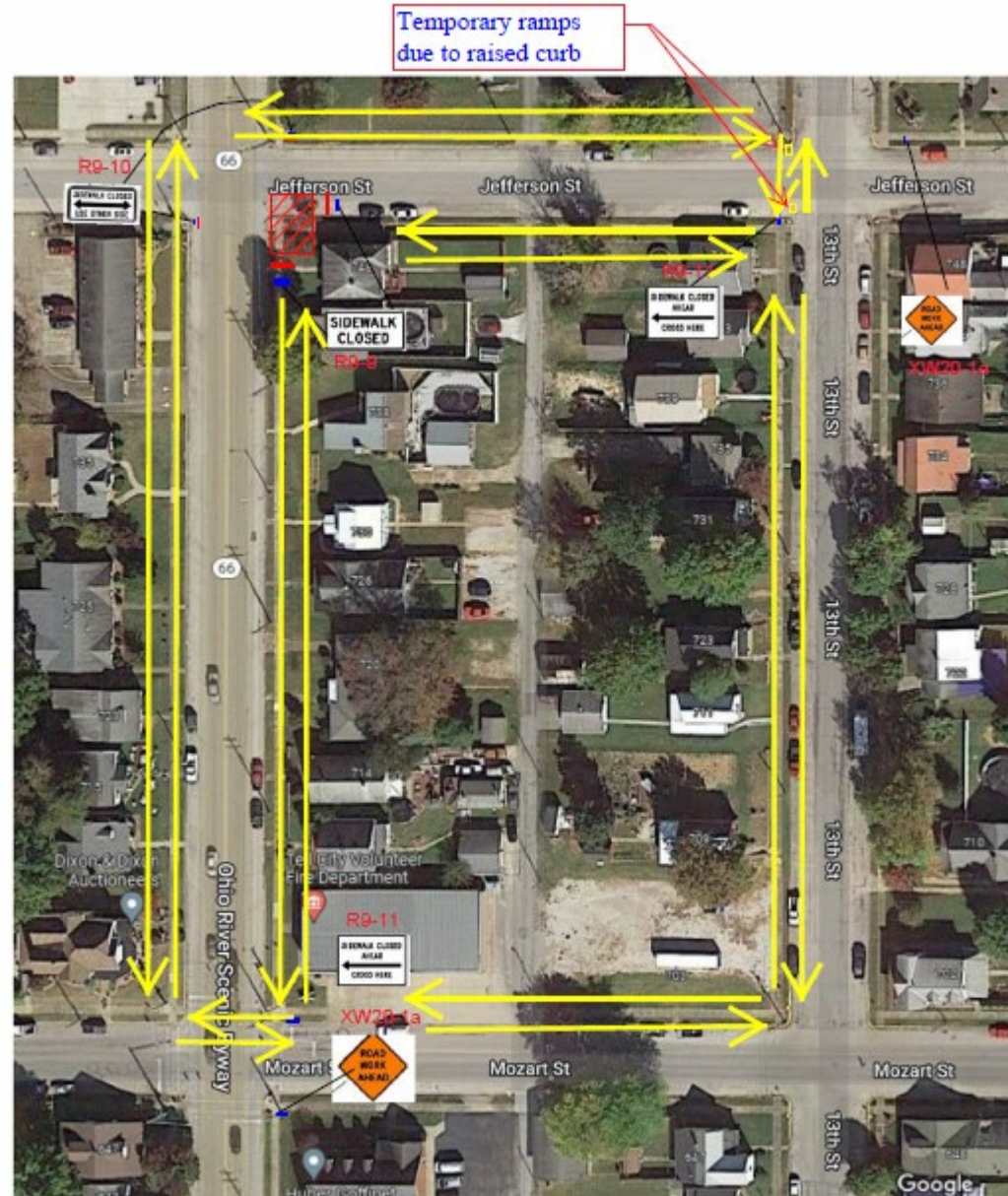

Detour

- Review the detour and determine if it replicates the existing pedestrian access route being detoured
 - Are there any gaps in the sidewalk detour?
 - Is the sidewalk detour within public right-of-way?
 - Does the sidewalk detour have curb ramps or curbs or a combination?
- Consider the project duration (Term “duration” used are not IMUTCD defined)
 - Is the work being completed short in duration (less than 4 months)?
 - Filling a 20 ft gap with sidewalk or placing temporary bituminous ramps at intersection without curb ramps within public right-of-way may be practical.
 - Having to reconstruct an entire city block or construction a 20 ft gap outside of public right-of-way may not be practical
 - Is the work being completed long in duration (more than 4 months or multiple construction seasons)?,
 - coordinating with an LPA or upgrade a detour route to match or exceed the existing sidewalk being detoured may be practical.

Detour

- Detour Signage Expectation
 - Sidewalk Closure Signs
 - Pedestrian Detour Signs
 - Turns
 - Confirmation
 - End
 - Closure Communication Signs, “Sidewalk Closed on or after “Date”

Detour

- Detour Signage Expectation, the intended route should be very clear. Detectable Barricade the covers the entire width of the sidewalk

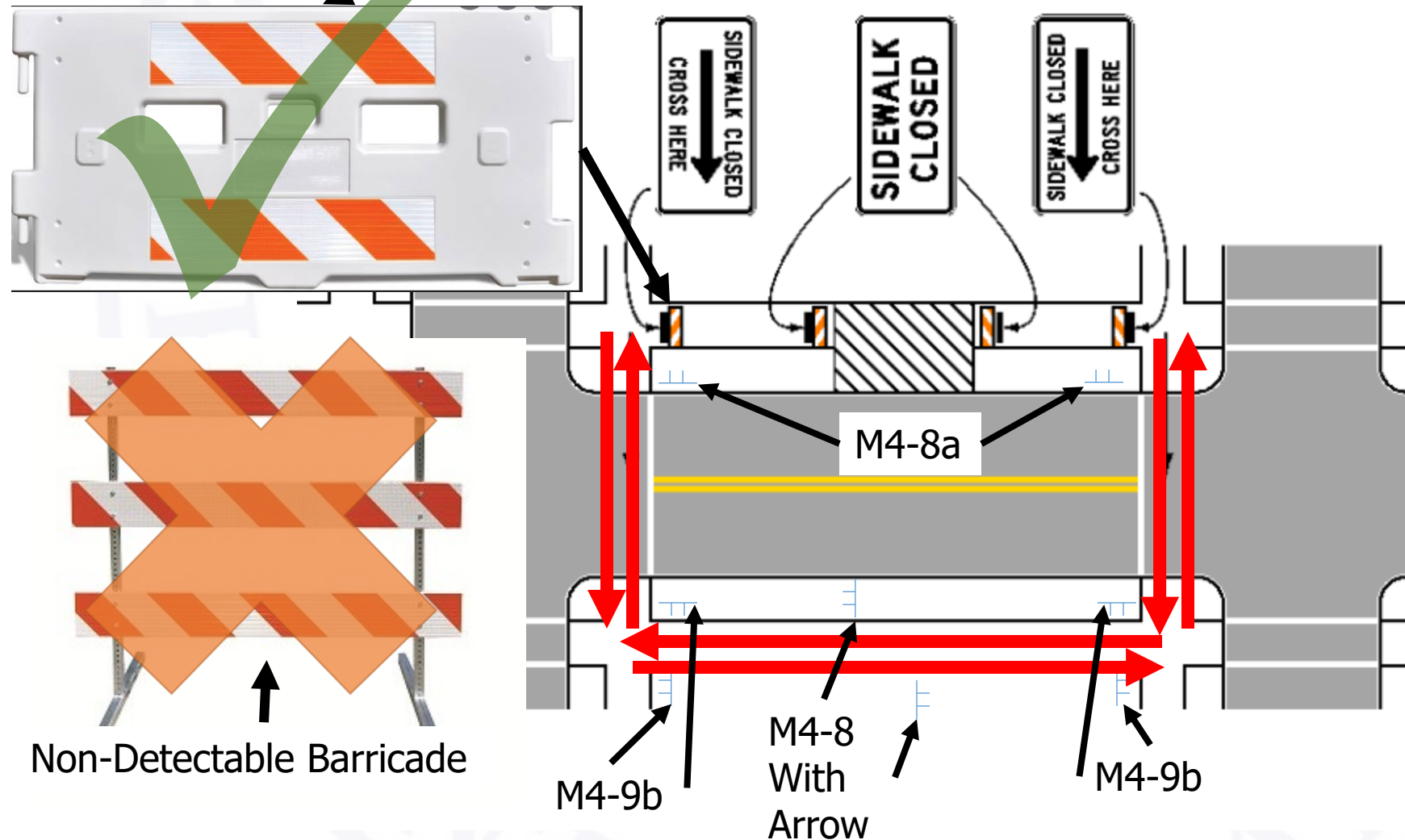

M4-9b



M4-8a

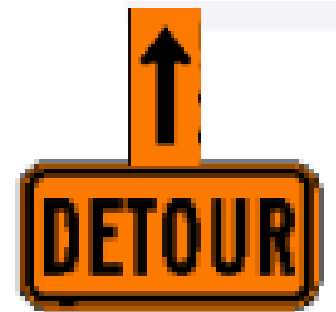





M4-8

Detour

Standard Drawings for the different pedestrian MOT schemes are also in development.

Short Detour/

Long Detour with
Closure Time Restriction

-  Ped Traffic from the East
-  Ped Traffic from the West
-  Ped Traffic from the South
-  Ped Traffic from the North

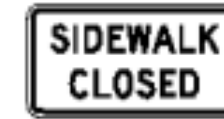
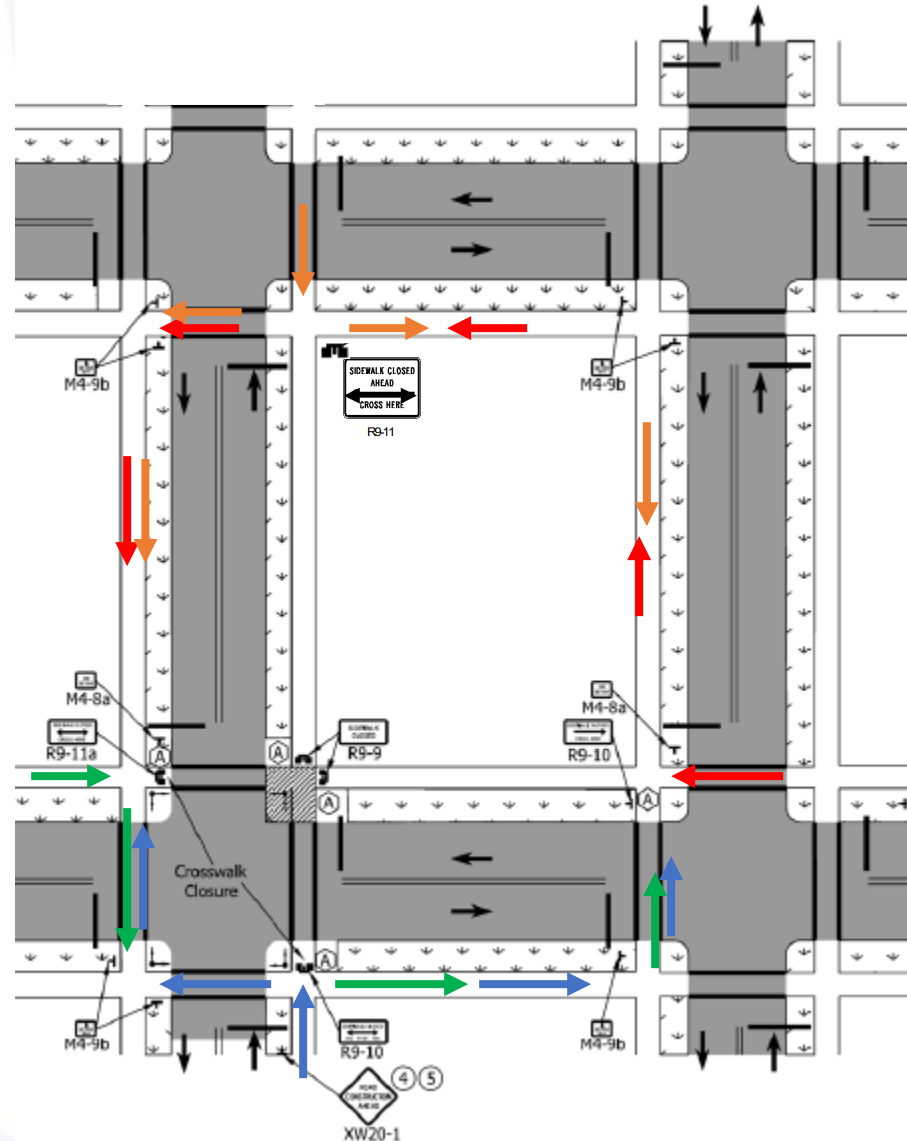

R9-9

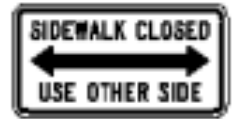

R9-10



M4-8



M4-8a



M4-9b

Detour

- Long Detour

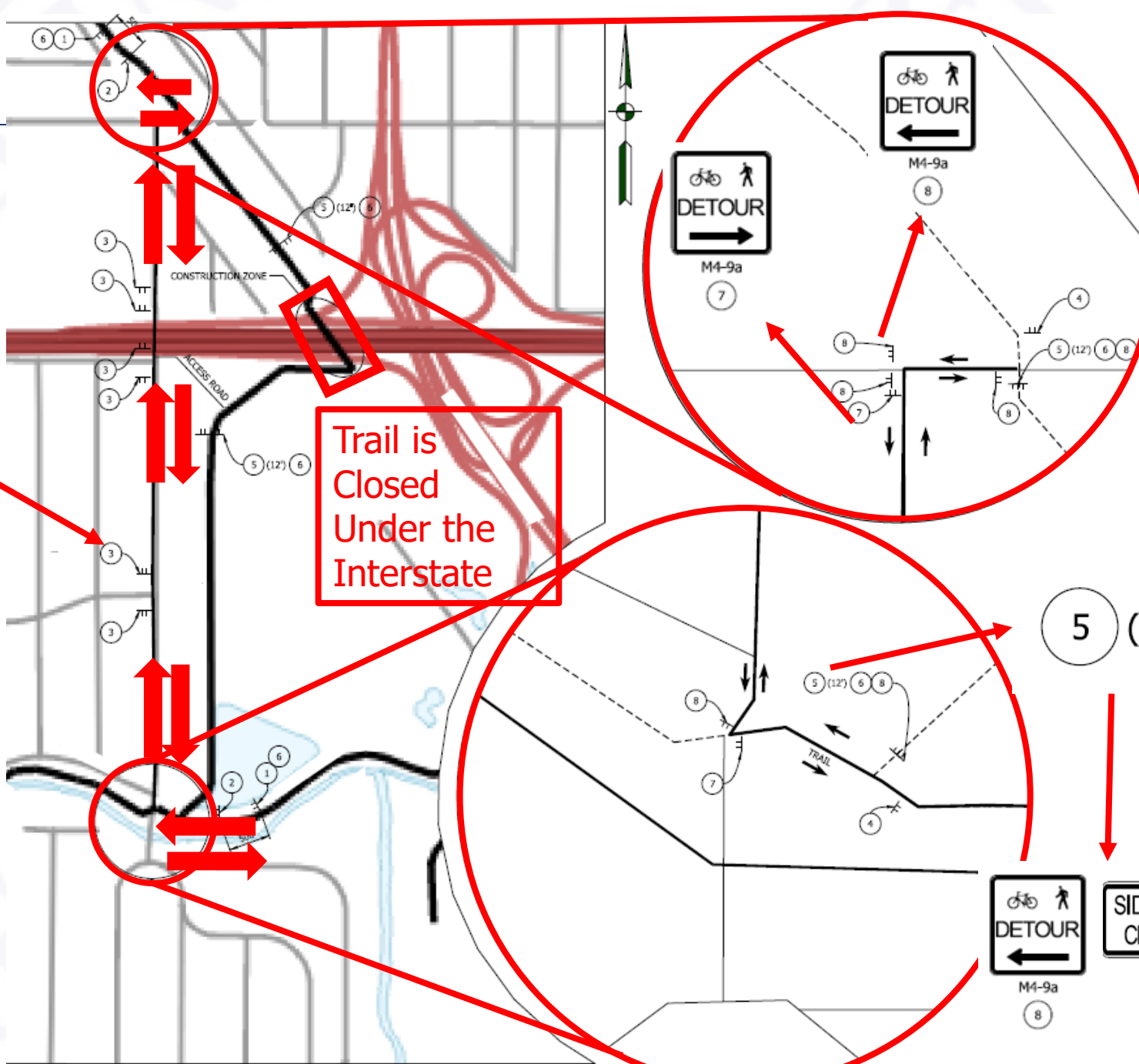

Trail is Closed Under the Interstate



5 (12')

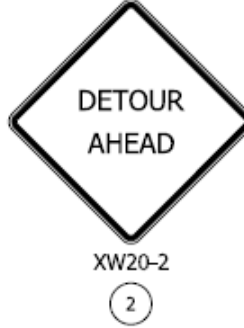
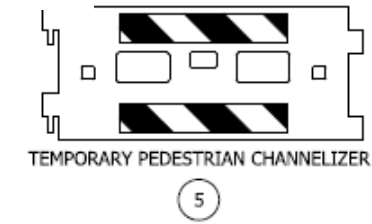

DETOUR PLAN

Alternate Pedestrian Route Hierarchy

1. Diversion
 - a. Right-of-Way Side
 - b. Street Side
2. Detour
 - a. Midblock Crossing
 - b. Short Detour
 - c. Long Detour with Closure Time Restriction
3. Closure Time Restriction ONLY

A combination of these schemes could be used throughout a project or even for one closure as shown in our example.

- The list above is the start of a preliminary hierarchy of pedestrian maintenance of traffic schemes that should be considered. This list will be part of the future IDM Chapter 503 update coming soon.
- Each item in this hierarchy that can not be used **MUST** be documented, e.g. what was explored, why it was ruled not practical, etc.

Example Hierarchy Documents

Explanation of why a scheme will not work and what scheme is being recommended, which in this case is highlighted in Green

PEDESTRIAN MOT TREATMENT DETERMINATION

Intersection and Curb Ramp Location: US 27 @ Elder St Southeast Quadrant Ramp Construction

Movement 1: Northbound along US 27

1	House Side Diversion	Insufficient R/W width
2	Street Side Diversion	Insufficient roadway width along US 27; utilities in buffer strip.
3	Mid Block Crossing	Insufficient roadway width along US 27. US 27 is curbed.
4	Short Detour	Pedestrian crossings of US 27 1 block to the south at Clark Street and 2 blocks to the north at 7th St.
5	Long Detour	Northbound US 27 ped traffic can cross to west side of US 27 at the existing Clark Street crossing, then re-access US 27 north of the ramp construction by following the west side of US 27 and crossing US 27 at 7th Street.
6	Time Restricted Closure	

Movement 2: Southbound along US 27

1	House Side Diversion	Insufficient R/W width
2	Street Side Diversion	Insufficient roadway width along US 27; utilities in buffer strip.
3	Mid Block Crossing	Insufficient roadway width along US 27. US 27 is curbed.
4	Short Detour	Pedestrian crossings of US 27 1 block to the south at Clark Street and 2 blocks to the north at 7th St.
5	Long Detour	Southbound US 27 ped traffic can cross to west side of US 27 at 7th Street, then re-access US 27 south of the ramp construction by following the west side of US 27 and crossing US 27 at the existing Clark St crossing.
6	Time Restricted Closure	

Movement 3: NB along US 27 to EB along Elder St/ WB along Elder St to SB along US 27

1	House Side Diversion	Insufficient R/W width
2	Street Side Diversion	Insufficient roadway width along US 27 and Elder St.
3	Mid Block Crossing	Insufficient roadway width along US 27. US 27 is curbed. Elder St is curbed and crossings would extend into the Elder St travel lanes.
4	Short Detour	No pedestrian crossings exist along Elder St within a city block of the US 27/Elder St intersection.
5	Long Detour	The closest pedestrian crossing of Elder St is at the CR 149 E Intersection. Pedestrian traffic movements could follow Floral Avenue (from US 27) and CR 149 E to Elder St, utilizing at CR 149 E to access either side of Elder St, however the sidewalk along Floral Avenue and Elder St does not have curb ramps at intersections and is not ADA compliant.
6	Time Restricted Closure	RECOMMENDED AS NO DETOUR IS AVAILABLE

Movement 4: SB along US 27 to EB along Elder St / WB along Elder St to NB along US 27

1	House Side Diversion	Insufficient R/W width
2	Street Side Diversion	Insufficient roadway width along US 27 and Elder St.
3	Mid Block Crossing	Insufficient roadway width along US 27. US 27 is curbed. Elder St is curbed and 19' wide. Midblock crossings would extend into the Elder St travel lanes.
4	Short Detour	No pedestrian crossings exist along Elder St within a city block of the US 27/Elder St intersection.
5	Long Detour	The closest pedestrian crossing of Elder St is at the CR 149 E Intersection. Pedestrian traffic for these movements could access the other side of Elder St using the crossing at this intersection, however the sidewalk along Elder St does not have curb ramps at intersections and is not ADA compliant.
6	Time Restricted Closure	RECOMMENDED AS NO DETOUR IS AVAILABLE

Define the Intersection

Define Each pedestrian path for that Intersection Quadrant

Proposed curb ramp in SE corner

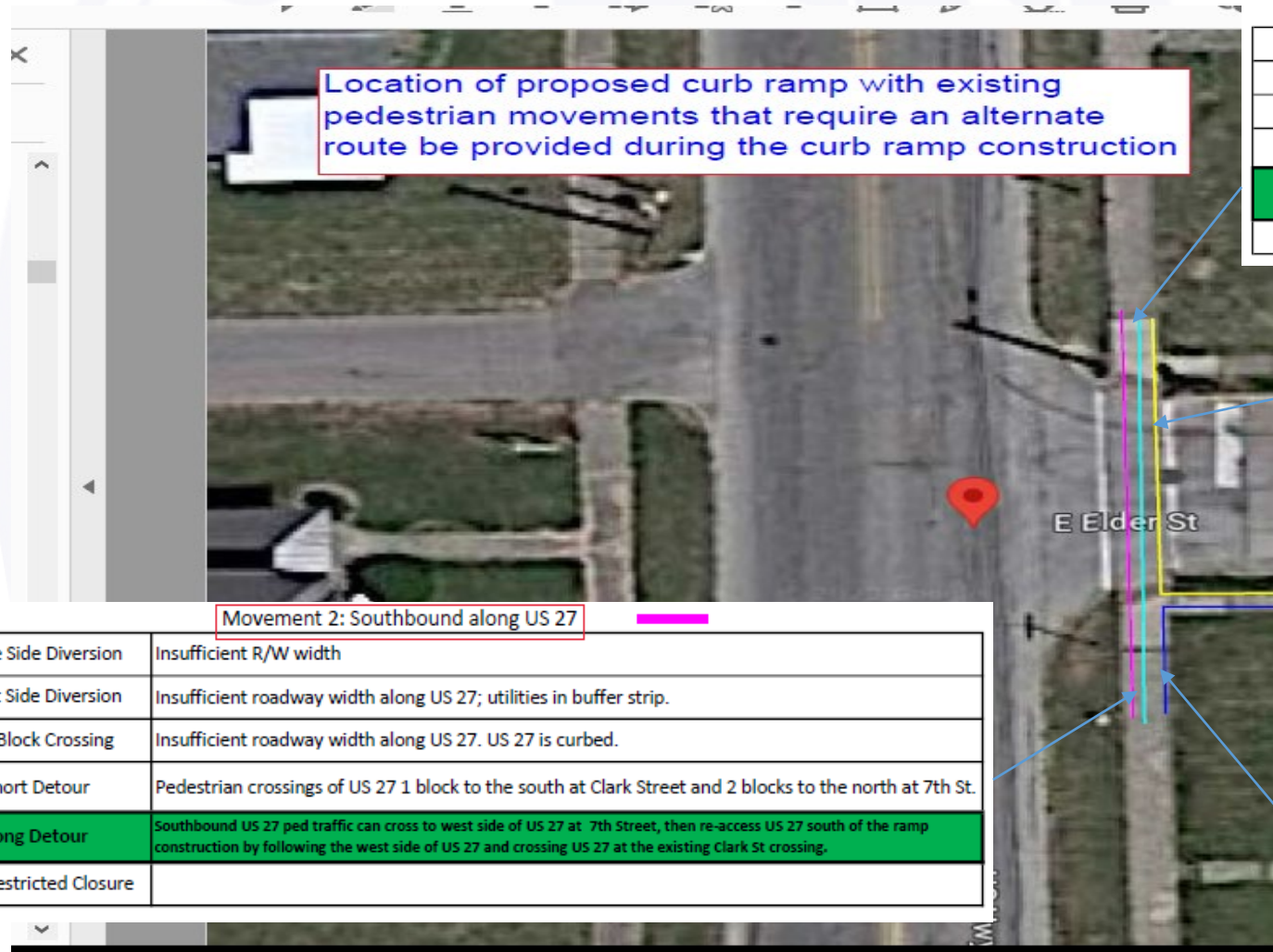

Location of proposed curb ramp with existing pedestrian movements that require an alternate route be provided during the curb ramp construction

Movement 2: Southbound along US 27

House Side Diversion	Insufficient R/W width
Street Side Diversion	Insufficient roadway width along US 27; utilities in buffer strip.
Mid Block Crossing	Insufficient roadway width along US 27. US 27 is curbed.
Short Detour	Pedestrian crossings of US 27 1 block to the south at Clark Street and 2 blocks to the north at 7th St.
Long Detour	Southbound US 27 ped traffic can cross to west side of US 27 at 7th Street, then re-access US 27 south of the ramp construction by following the west side of US 27 and crossing US 27 at the existing Clark St crossing.
Time Restricted Closure	

Movement 1: Northbound along US 27

1	House Side Diversion	Insufficient R/W width
2	Street Side Diversion	Insufficient roadway width along US 27; utilities in buffer strip.
3	Mid Block Crossing	Insufficient roadway width along US 27. US 27 is curbed.
4	Short Detour	Pedestrian crossings of US 27 1 block to the south at Clark Street and 2 blocks to the north at 7th St.
5	Long Detour	Northbound US 27 ped traffic can cross to west side of US 27 at the existing Clark Street crossing, then re-access US 27 north of the ramp construction by following the west side of US 27 and crossing US 27 at 7th Street.
6	Time Restricted Closure	

Movement 4: SB along US 27 to EB along Elder St / WB along Elder St to NB along US 27

1	House Side Diversion	Insufficient R/W width
2	Street Side Diversion	Insufficient roadway width along US 27 and Elder St.
3	Mid Block Crossing	Insufficient roadway width along US 27. US 27 is curbed. Elder St is curbed. Elder St crossings would extend into the Elder St travel lanes.
4	Short Detour	No pedestrian crossings exist along Elder St within a city block of the US 27.
5	Long Detour	The closest pedestrian crossing of Elder St is at the CR 149 E intersection. Pedestrian movements could access the other side of Elder St using the crossing at this intersection. The sidewalk along Elder St does not have curb ramps at intersections and is not ADA compliant.
6	Time Restricted Closure	RECOMMENDED AS NO DETOUR IS AVAILABLE

Movement 3: NB along US 27 to EB along Elder St/ WB along Elder St to SB along US 27

1	House Side Diversion	Insufficient R/W width
2	Street Side Diversion	Insufficient roadway width along US 27 and Elder St.
3	Mid Block Crossing	Insufficient roadway width along US 27. US 27 is curbed. Elder St is curbed. Elder St crossings would extend into the Elder St travel lanes.
4	Short Detour	No pedestrian crossings exist along Elder St within a city block of the US 27.
5	Long Detour	The closest pedestrian crossing of Elder St is at the CR 149 E intersection. Pedestrian movements could follow Floral Avenue (from US 27) and CR 149 E to Elder St, utilizing the crossing at CR 149 E to access either side of Elder St, however the sidewalk along Floral Avenue does not have curb ramps at intersections and is not ADA compliant.

Example Hierarchy Documents

PEDESTRIAN MOT TREATMENT DETERMINATION

Intersection and Curb Ramp Location: US 27 @ Elder St Southeast Quadrant Ramp Construction

Movement 1: Northbound along US 27

1	House Side Diversion	Insufficient R/W width
2	Street Side Diversion	Insufficient roadway width along US 27; utilities in buffer strip.
3	Mid Block Crossing	Insufficient roadway width along US 27. US 27 is curbed.
4	Short Detour	Pedestrian crossings of US 27 1 block to the south at Clark Street and 2 blocks to the north at 7th St.
5	Long Detour	Northbound US 27 ped traffic can cross to west side of US 27 at the existing Clark Street crossing, then re-access US 27 north of the ramp construction by following the west side of US 27 and crossing US 27 at 7th Street.
6	Time Restricted Closure	

Movement 2: Southbound along US 27

1	House Side Diversion	Insufficient R/W width
2	Street Side Diversion	Insufficient roadway width along US 27; utilities in buffer strip.
3	Mid Block Crossing	Insufficient roadway width along US 27. US 27 is curbed.
4	Short Detour	Pedestrian crossings of US 27 1 block to the south at Clark Street and 2 blocks to the north at 7th St.
5	Long Detour	Southbound US 27 ped traffic can cross to west side of US 27 at the existing Clark Street crossing, then re-access US 27 south of the ramp construction by following the west side of US 27 and crossing US 27 at 7th Street.
6	Time Restricted Closure	

If your Pedestrian MOT is one of the first 4 Schemes. File the scheme selection with your Design Files

If your Pedestrian MOT is a long detour with time restriction closure or a Time restriction closure only, your documentation for those scheme selections will need to be submitted to the ADA Technical Advisory Committee (TAC)

Movement 3: Eastbound along Elder St / WB along Elder St

1	House Side Diversion	Insufficient R/W width
2	Street Side Diversion	Insufficient roadway width along US 27 and Elder St.
3	Mid Block Crossing	Insufficient roadway width along US 27. US 27 is curbed. Elder St is curbed and 19' wide. Midblock crossings would extend into the Elder St travel lanes.
4	Short Detour	No pedestrian crossings exist along Elder St within a city block of the US 27/Elder St intersection.
5	Long Detour	The closest pedestrian crossing of Elder St is at the CR 149 E Intersection. Pedestrian traffic for these movements could follow Floral Avenue (from US 27) and CR 149 E to Elder St, utilizing the Elder St crossing at CR 149 E to access either side of Elder St, however the sidewalk along Floral Avenue and Elder St does not have curb ramps at intersections and is not ADA compliant.
6	Time Restricted Closure	RECOMMENDED AS NO DETOUR IS AVAILABLE

Movement 4: SB along US 27 to EB along Elder St / WB along Elder St to NB along US 27

1	House Side Diversion	Insufficient R/W width
2	Street Side Diversion	Insufficient roadway width along US 27 and Elder St.
3	Mid Block Crossing	Insufficient roadway width along US 27. US 27 is curbed. Elder St is curbed and 19' wide. Midblock crossings would extend into the Elder St travel lanes.
4	Short Detour	No pedestrian crossings exist along Elder St within a city block of the US 27/Elder St intersection.
5	Long Detour	The closest pedestrian crossing of Elder St is at the CR 149 E Intersection. Pedestrian traffic for these movements could access the other side of Elder St using the crossing at this intersection, however the sidewalk along Elder St does not have curb ramps at intersections and is not ADA compliant.
6	Time Restricted Closure	RECOMMENDED AS NO DETOUR IS AVAILABLE

Street Side diversion examples

Location curb ramp SE corner intersection



Proposed Design

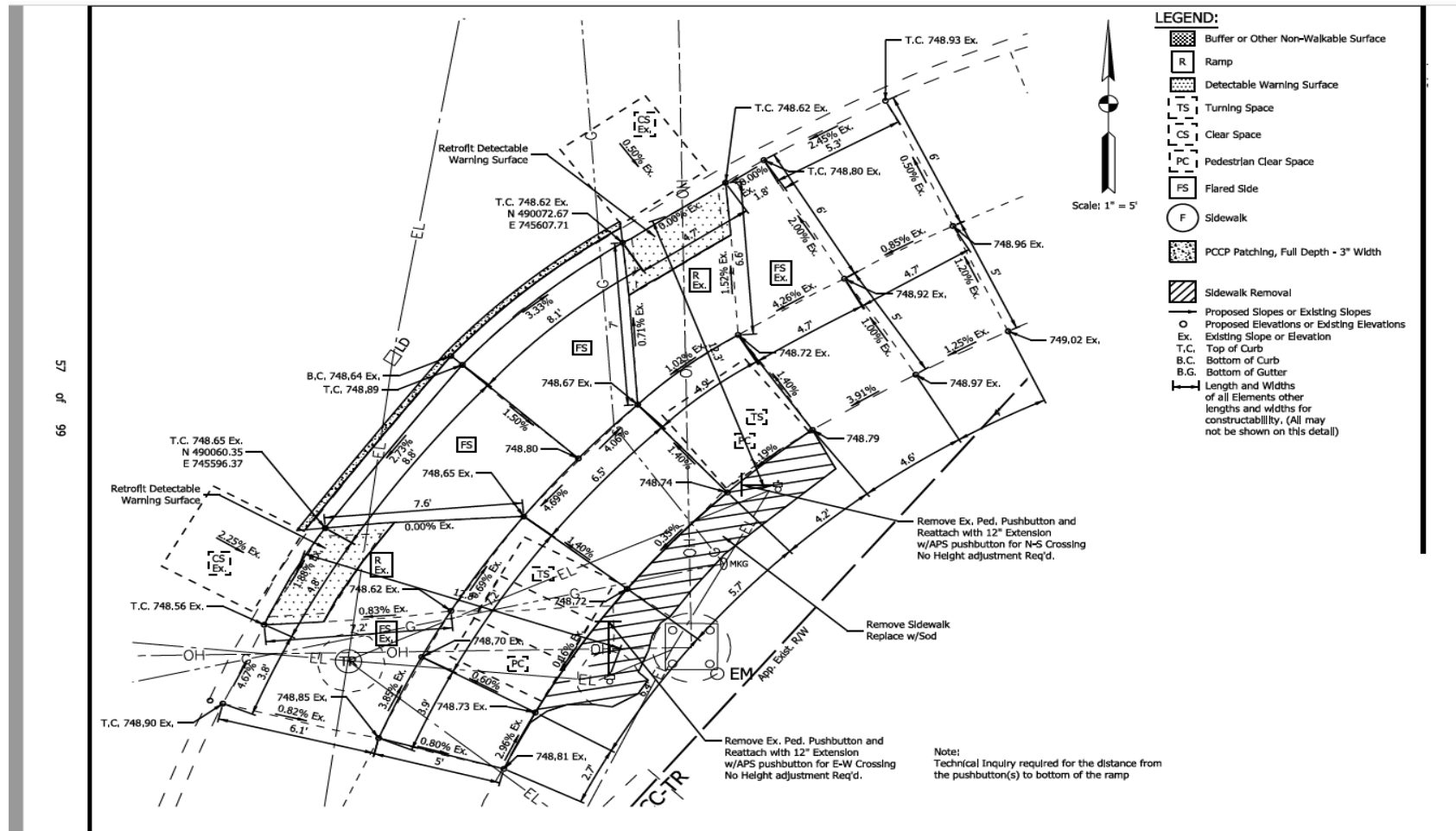

Proposed Curb ramp location and pedestrian circulation paths impacted

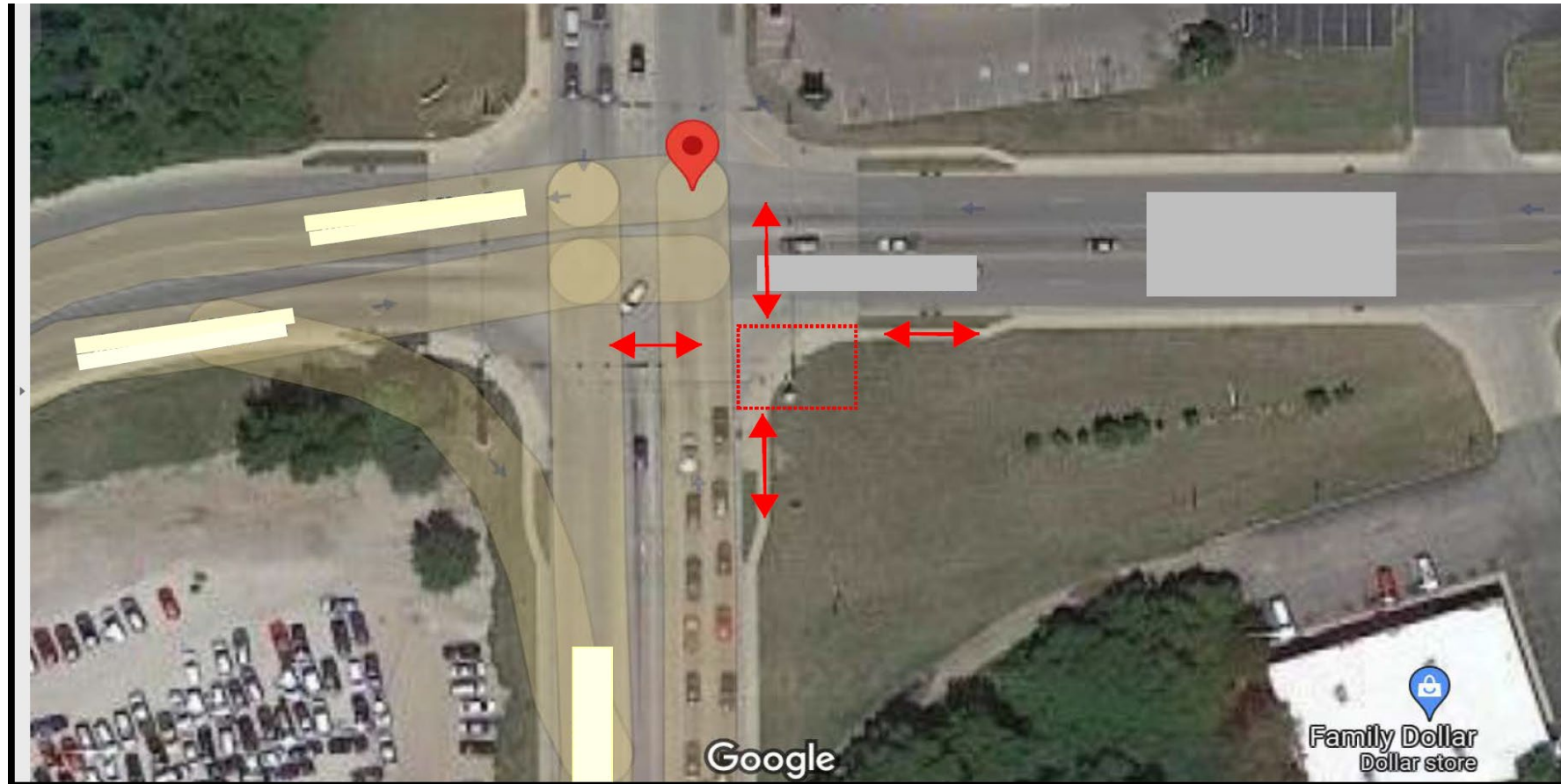

Will a diversion along right-of-way side work ?

A diversion on the right-of-way side was not possible because there was not enough existing right-of-way behind sidewalk to place diversion

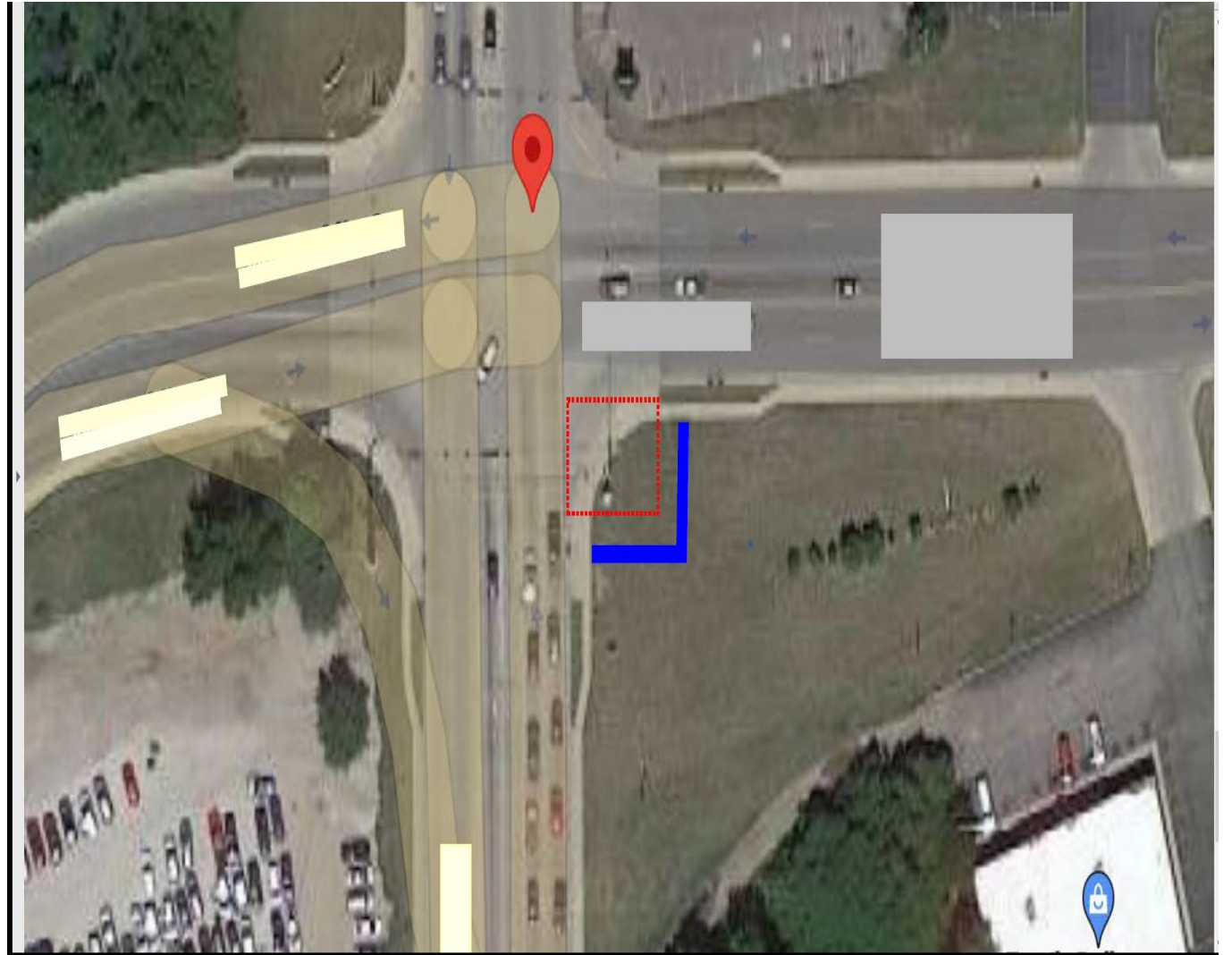

Proposed Diversion

- Everywhere between the sidewalk and the street was level except the concrete flared area shown in blue cross hatching
- Proposal is to reconstruct the flares and height of curb within cross hatched area to obtain level slopes (or at a minimum replicate the existing slopes within the sidewalk PAR being reconstructed shown in green)
- Reroute pedestrians to a created diversion, shown by orange dashed line, between the sidewalk and the street.
- Pedestrian Channelizers must be provided between the temporary PAR and the construction area

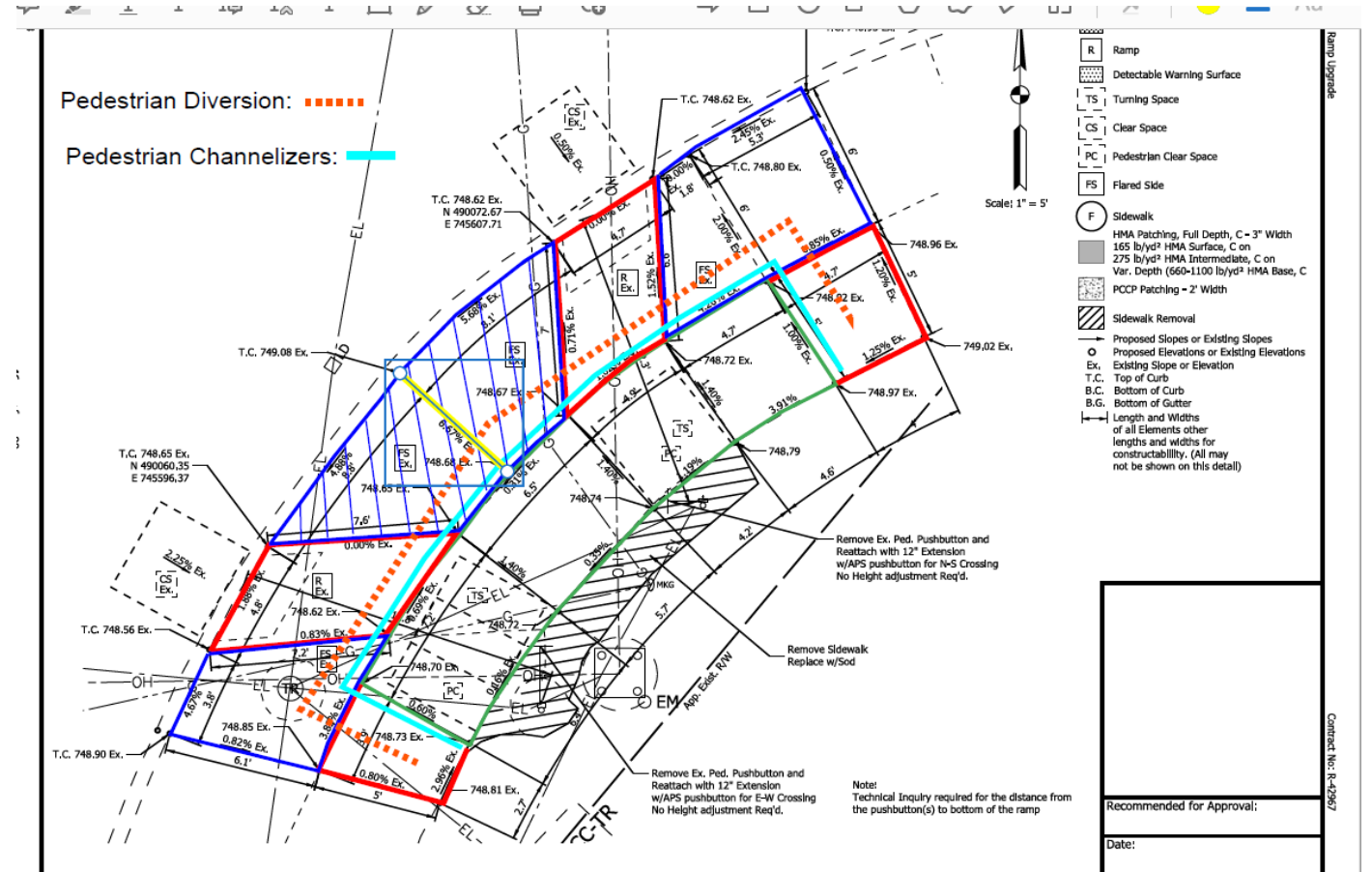

Proposed Roundabout

Location of Roundabout

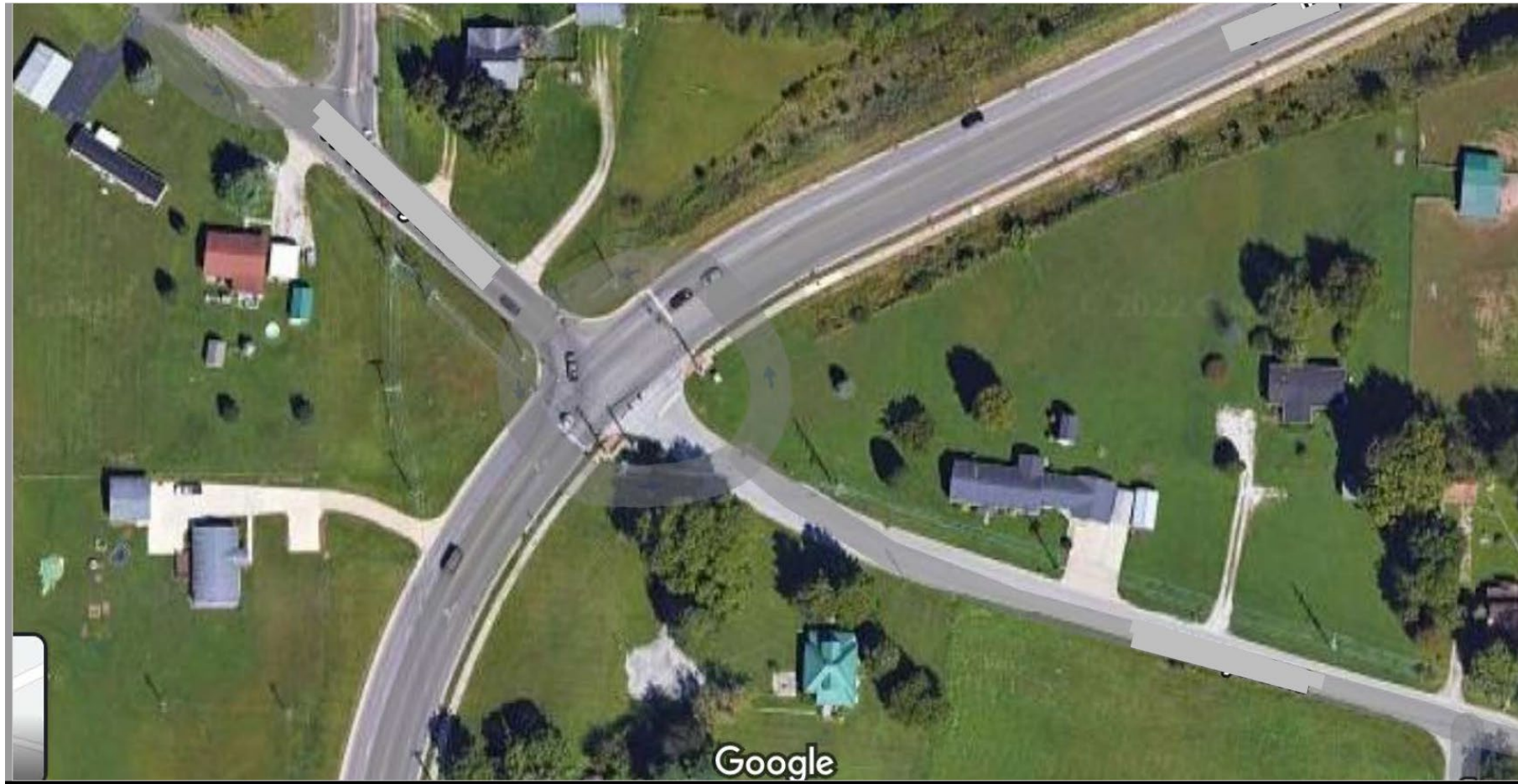

Pedestrian MOT issues

- PROWAG R205 requires an alternate pedestrian circulation path be provided for existing sidewalk on south side of existing road while roundabout is constructed
- A Technical Inquiry came to INDOT's ADA TAC not to provide an alternate path for the pedestrian circulation path on the south side because it was felt to be infeasible to do so due to lack of other existing pedestrian facilities

Option 1 for providing alternate pedestrian route

Provide temporary walking surface on right-of-way
side of roadway inside of existing R/W during phase 1
construction of roundabout

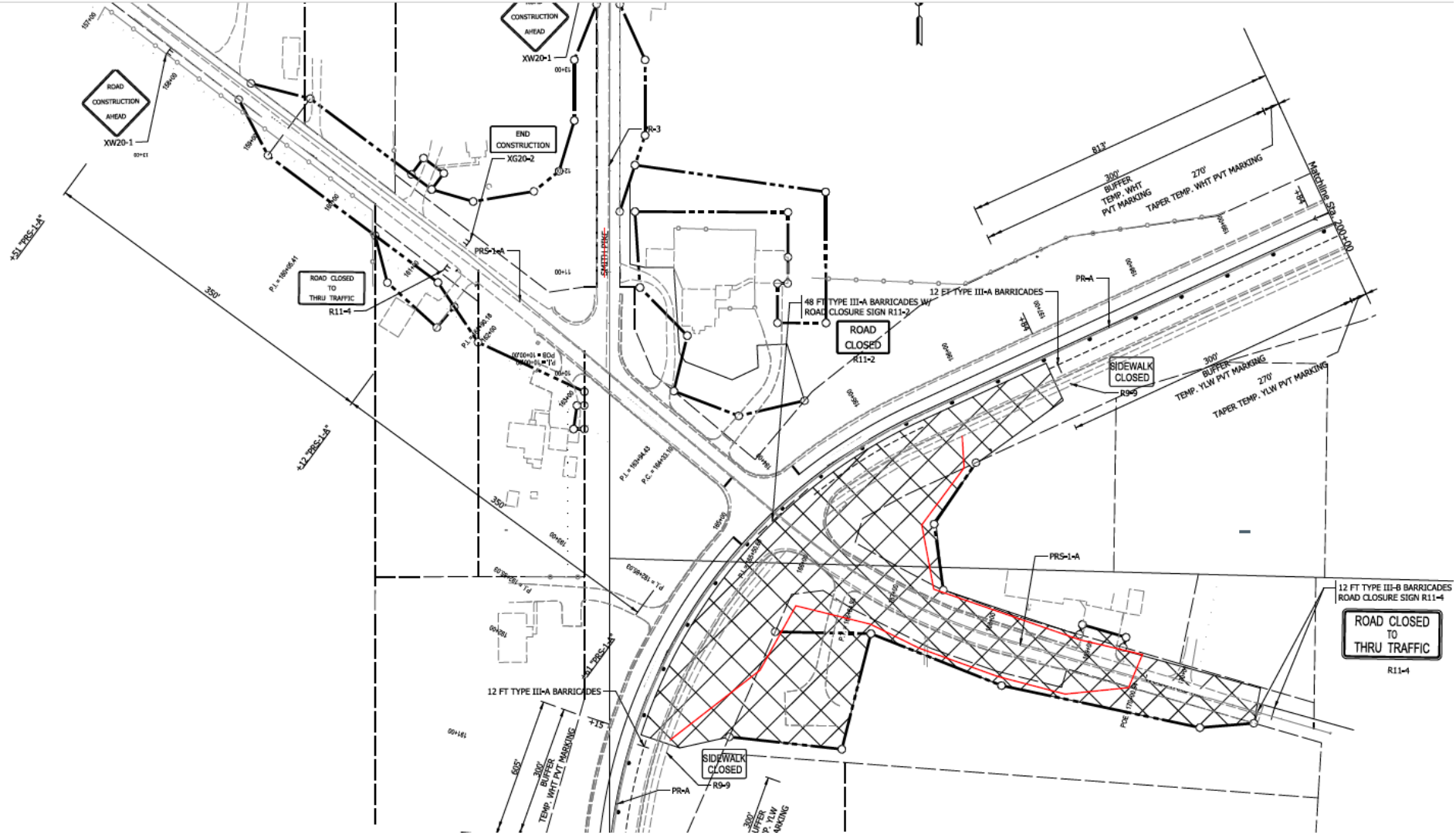

Why right-of-way side diversion will not work

- Right-of-way side diversion can't work is because not sufficient space within R/W to provide an adjacent path within appropriate setbacks from active construction

Option 2 for providing alternate
pedestrian route

Provide diversion on street side of phase 1
construction

Street side diversion

Plane view diversion

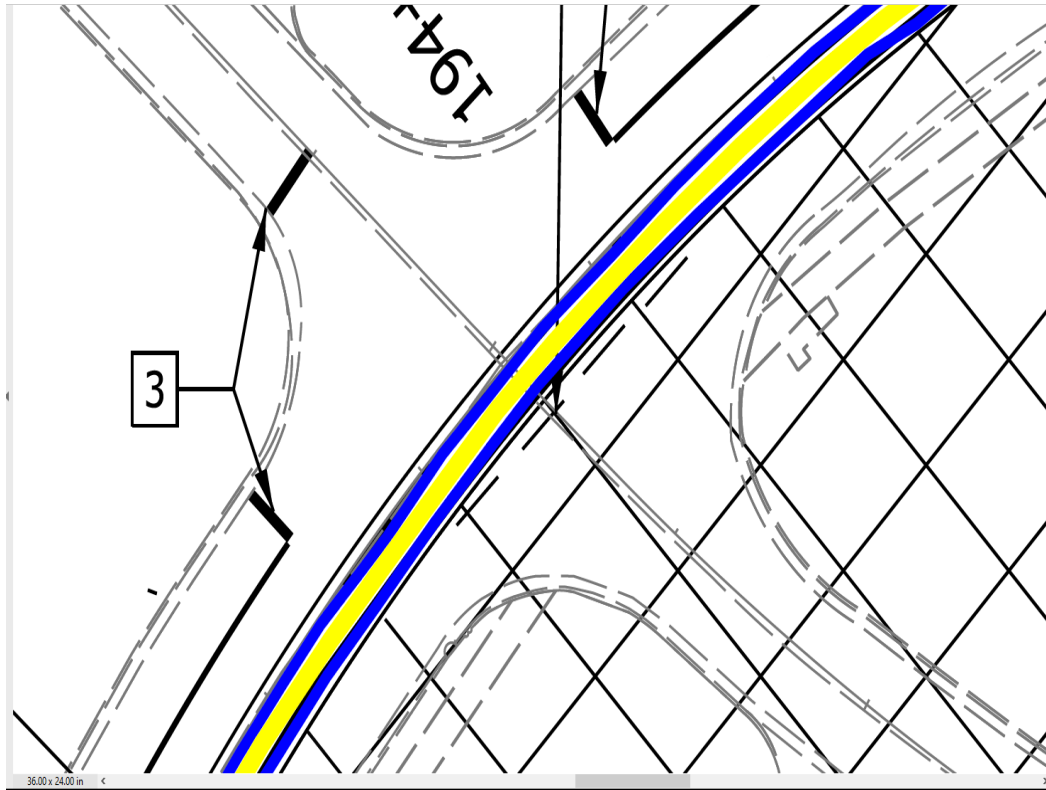

Cross section view diversion

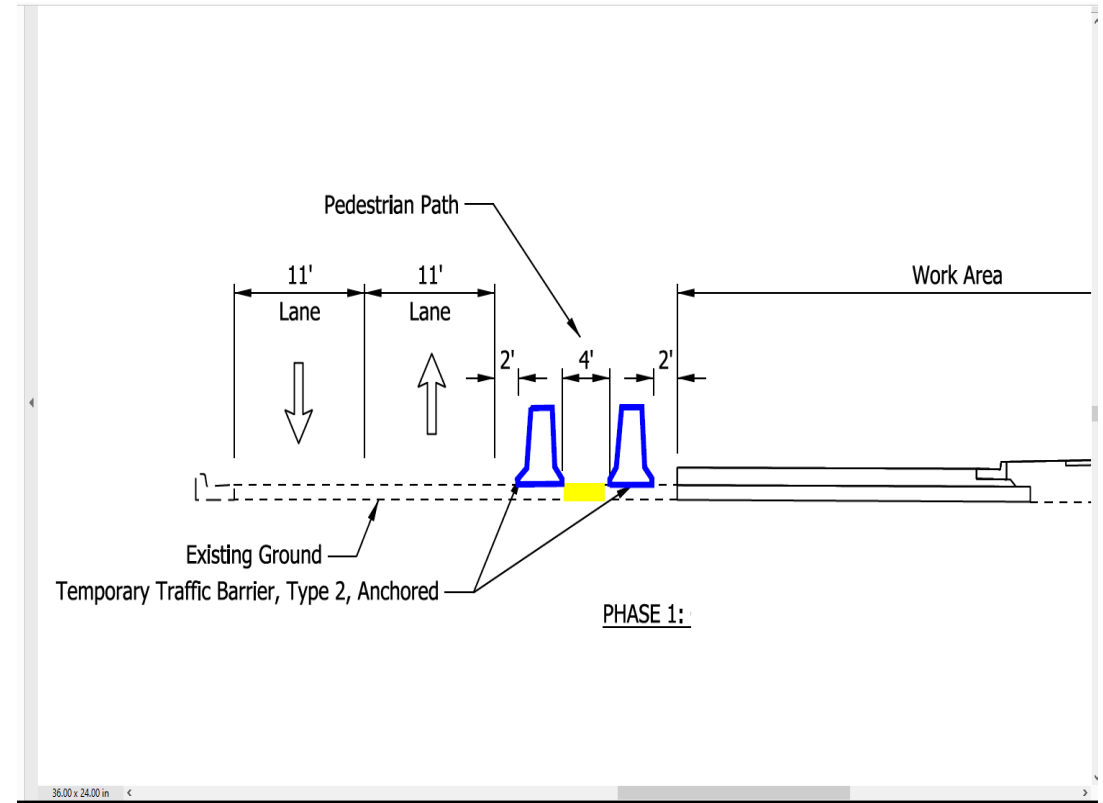

After phase 1 construction
maintain pedestrian mobility on
east side of roadway with newly
constructed sidewalk and curb
ramps and construct west side
of roundabout

Proposed curb ramp with street side diversion

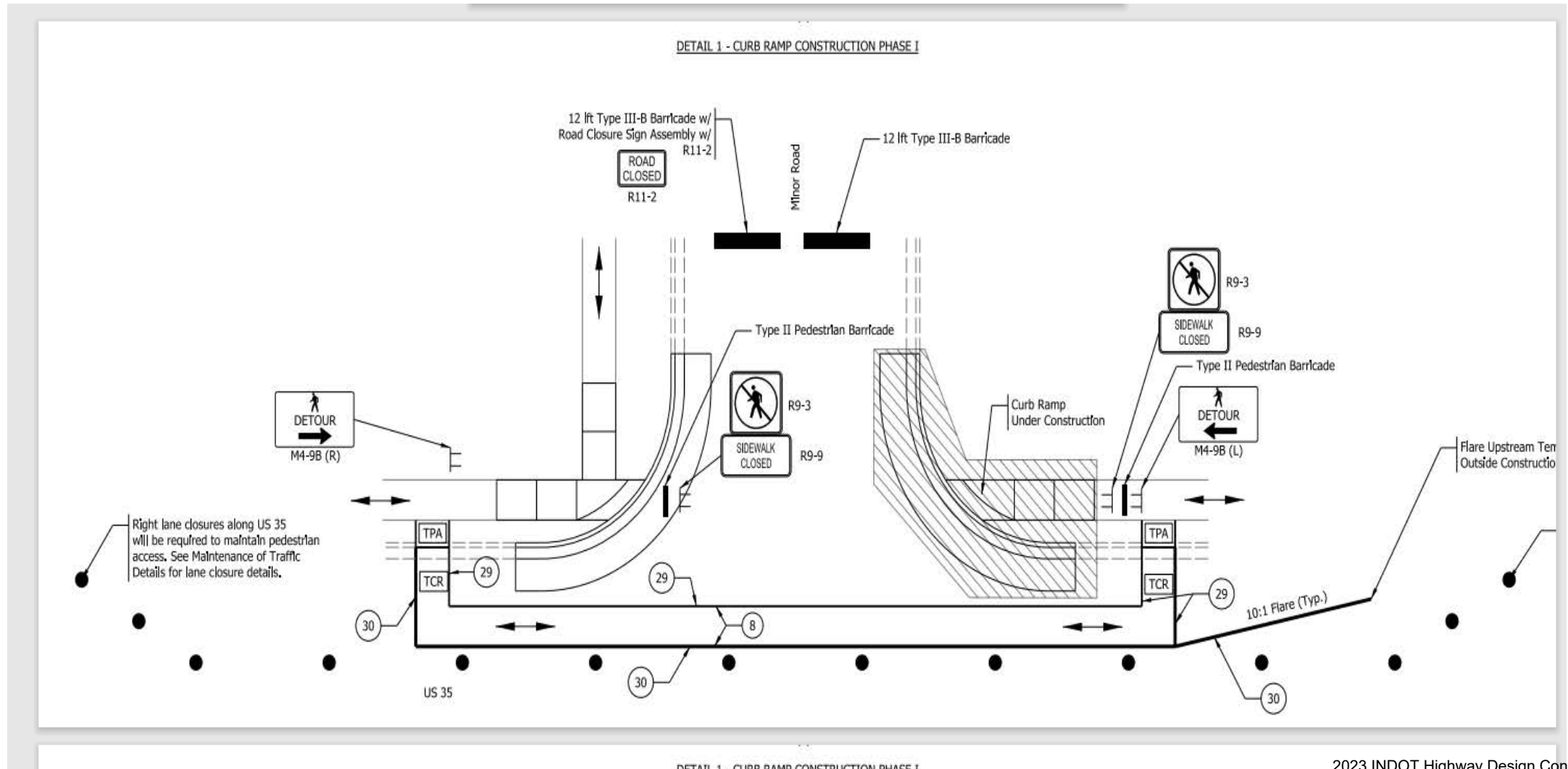

Comments on plans of street side diversion

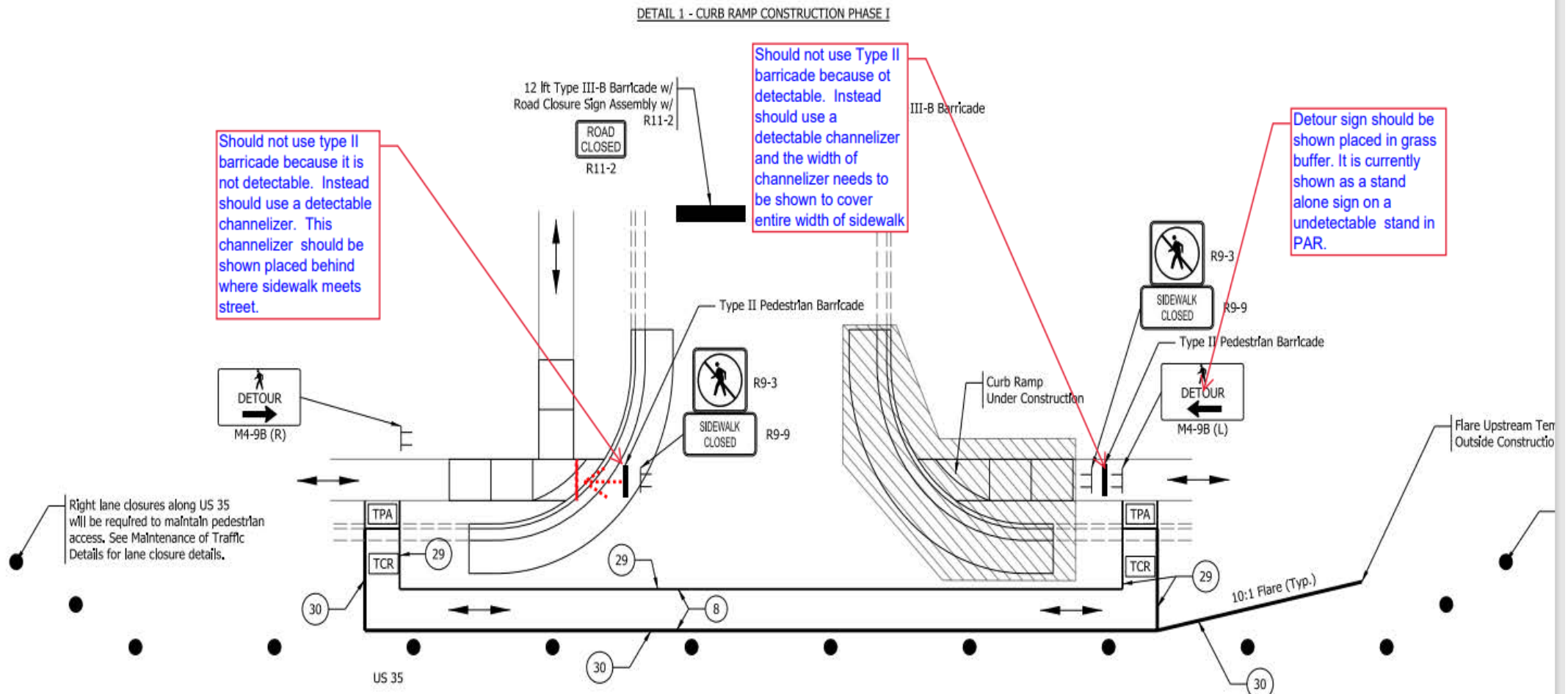

What was actually constructed



Small Structure Replacement

Location of project and Pedestrian MOT issues



Pedestrian MOT issues

- Provide Alternate pedestrian circulation path for sidewalk south of Main St. while small structure is installed and new sidewalk is installed

Option 1 for providing alternate pedestrian route

Use phase construction to keep existing
sidewalk open while new sidewalk is
constructed

Problem is existing sidewalk is located on the existing structure being replaced as well as the fill required. The fill will cover the existing sidewalk location making it impossible to keep open during construction of the new sidewalk.....

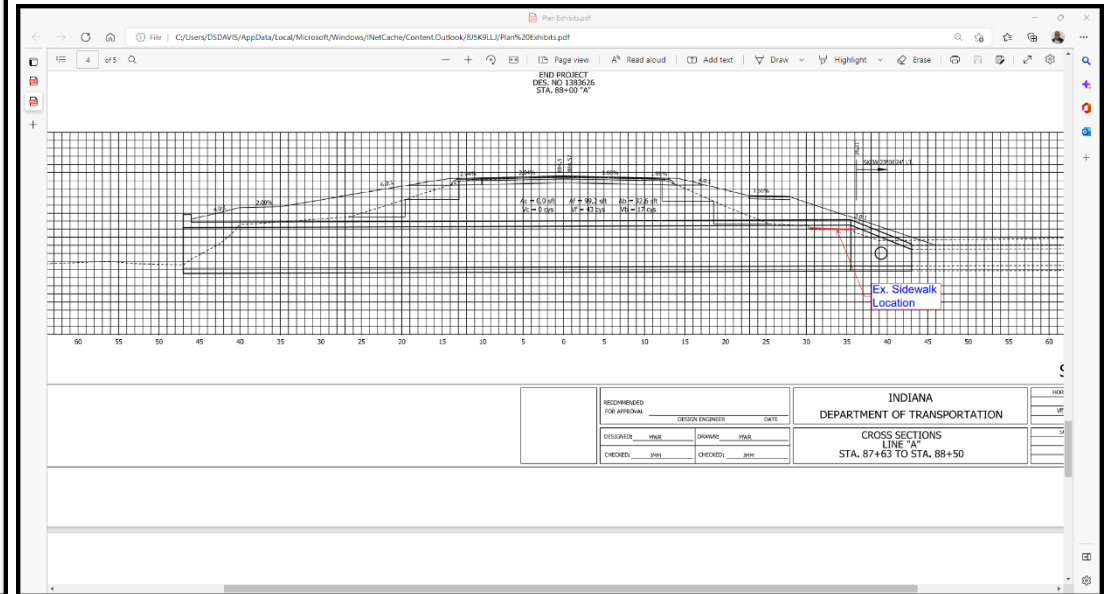
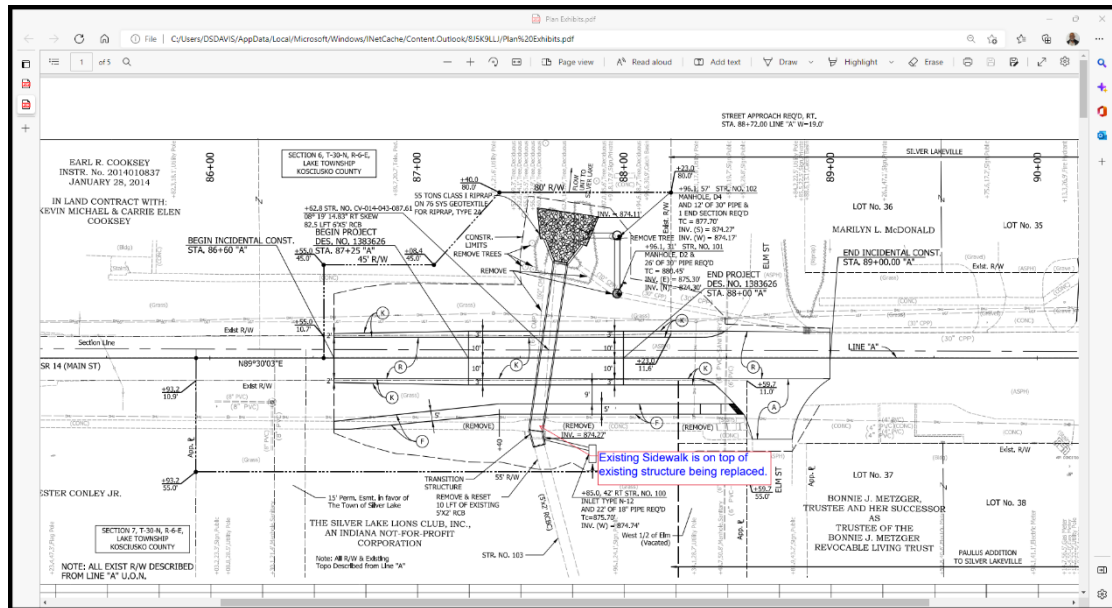

Option 2 for providing alternate

- Provide temporary crossing SR xx west of structure along with temporary walking surfaces from existing sidewalk on north side of SR xx
- Construct south side of project while maintaining pedestrians on north side of SR xx
- After south side of project is constructed maintain pedestrians on south side and construct north side of project

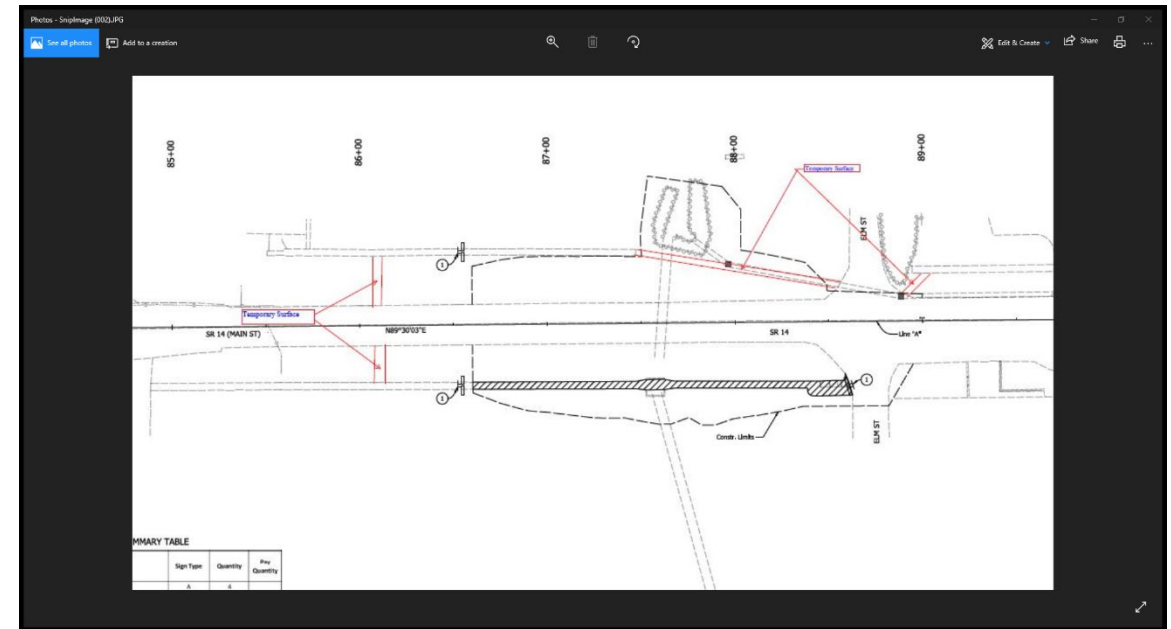

Final Pedestrian MOT phase 1

Maintain Pedestrians south side road existing sidewalk construct north side

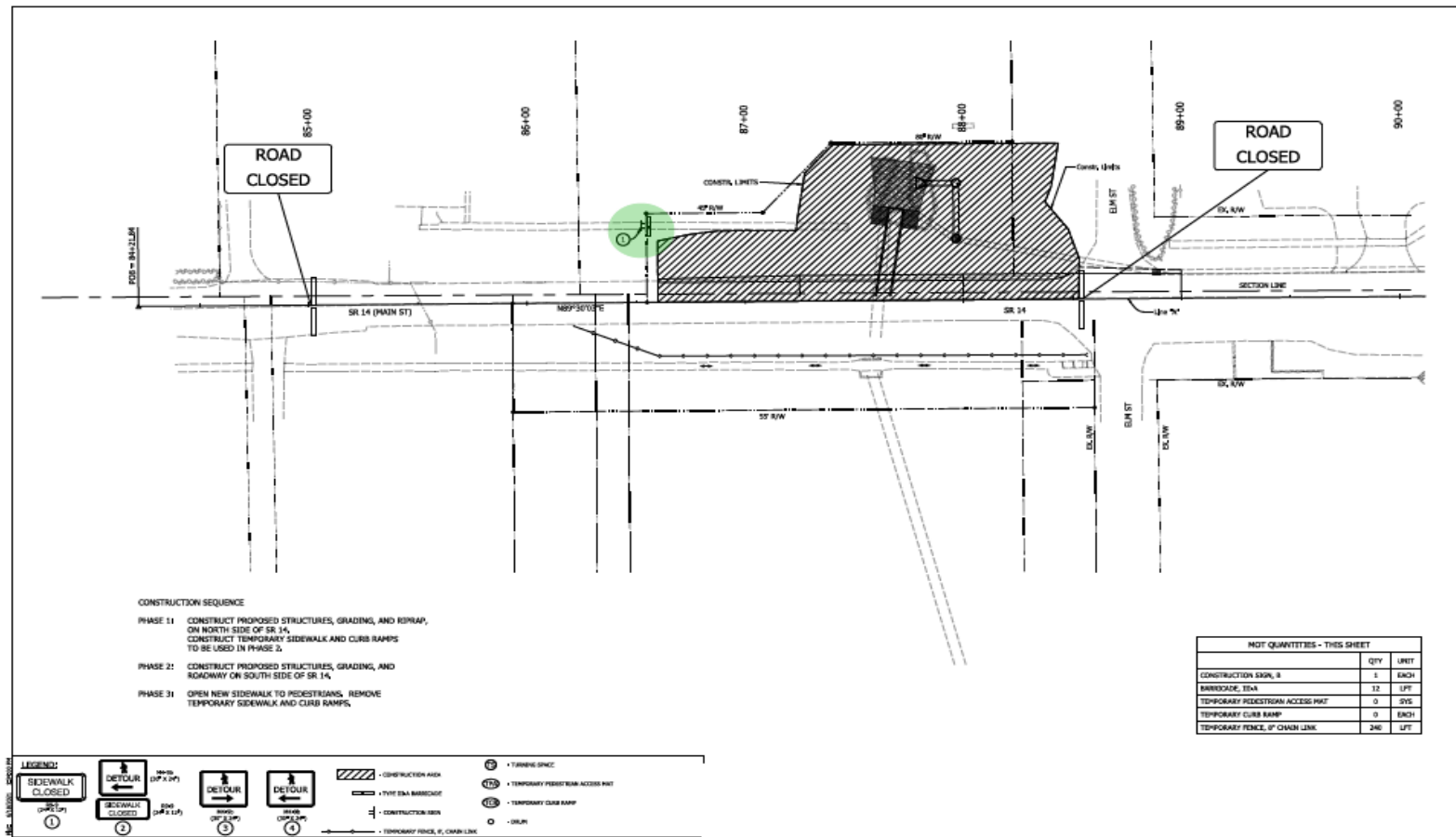

Comments on signage stage 1

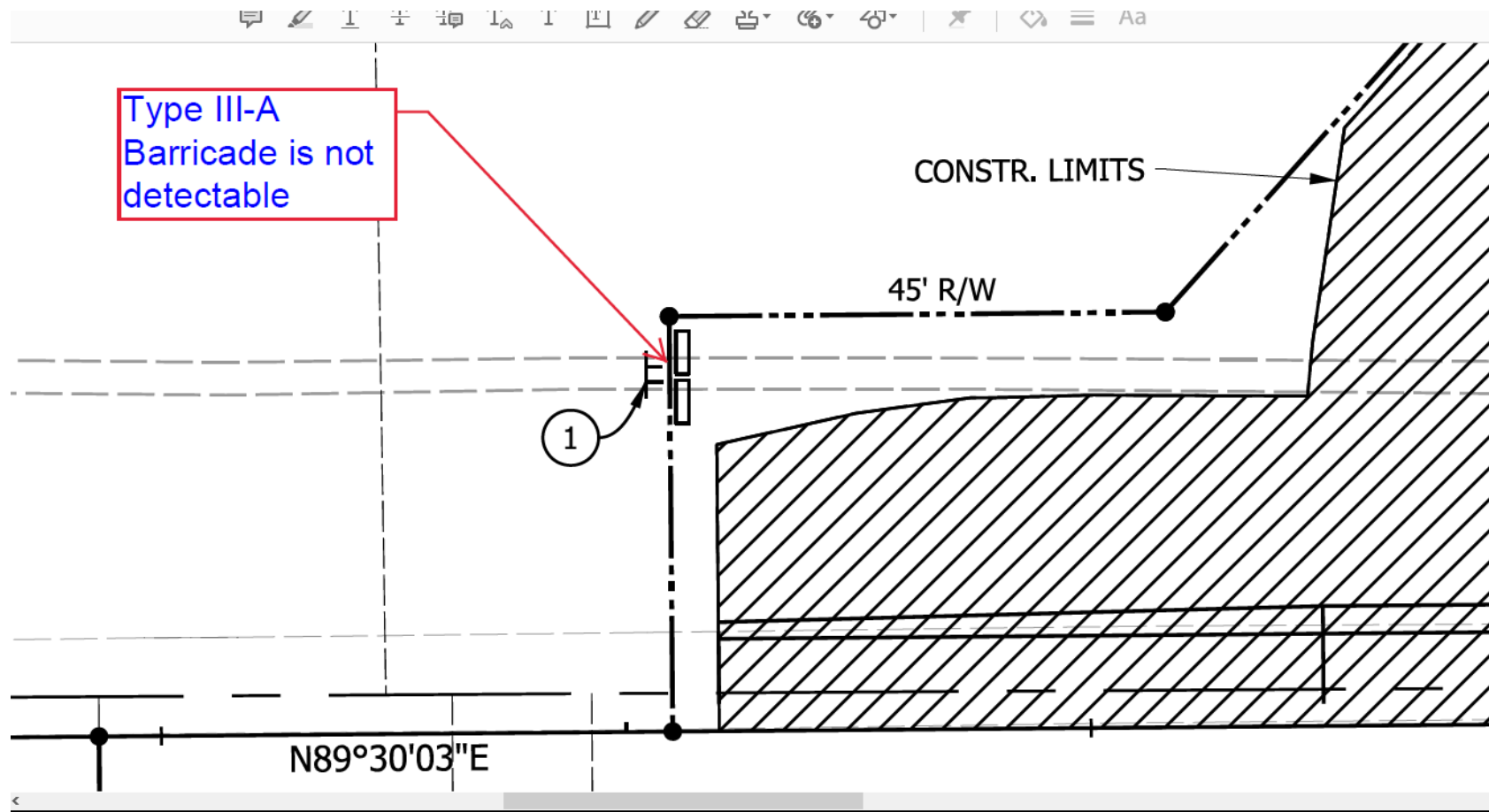

Final Pedestrian MOT phase 2

Maintain Pedestrians north side road existing sidewalk construct south side

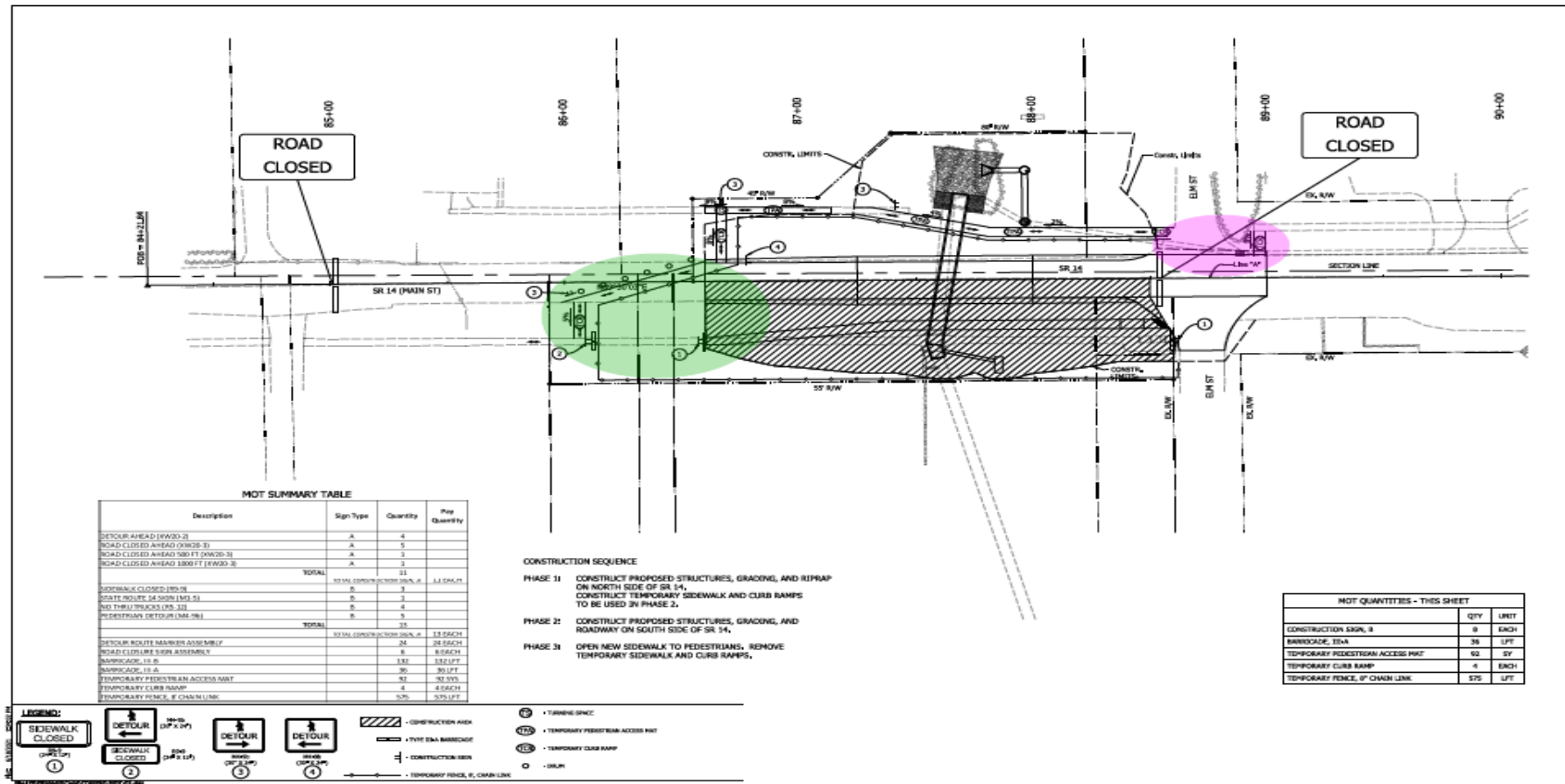

Comments on stage 2

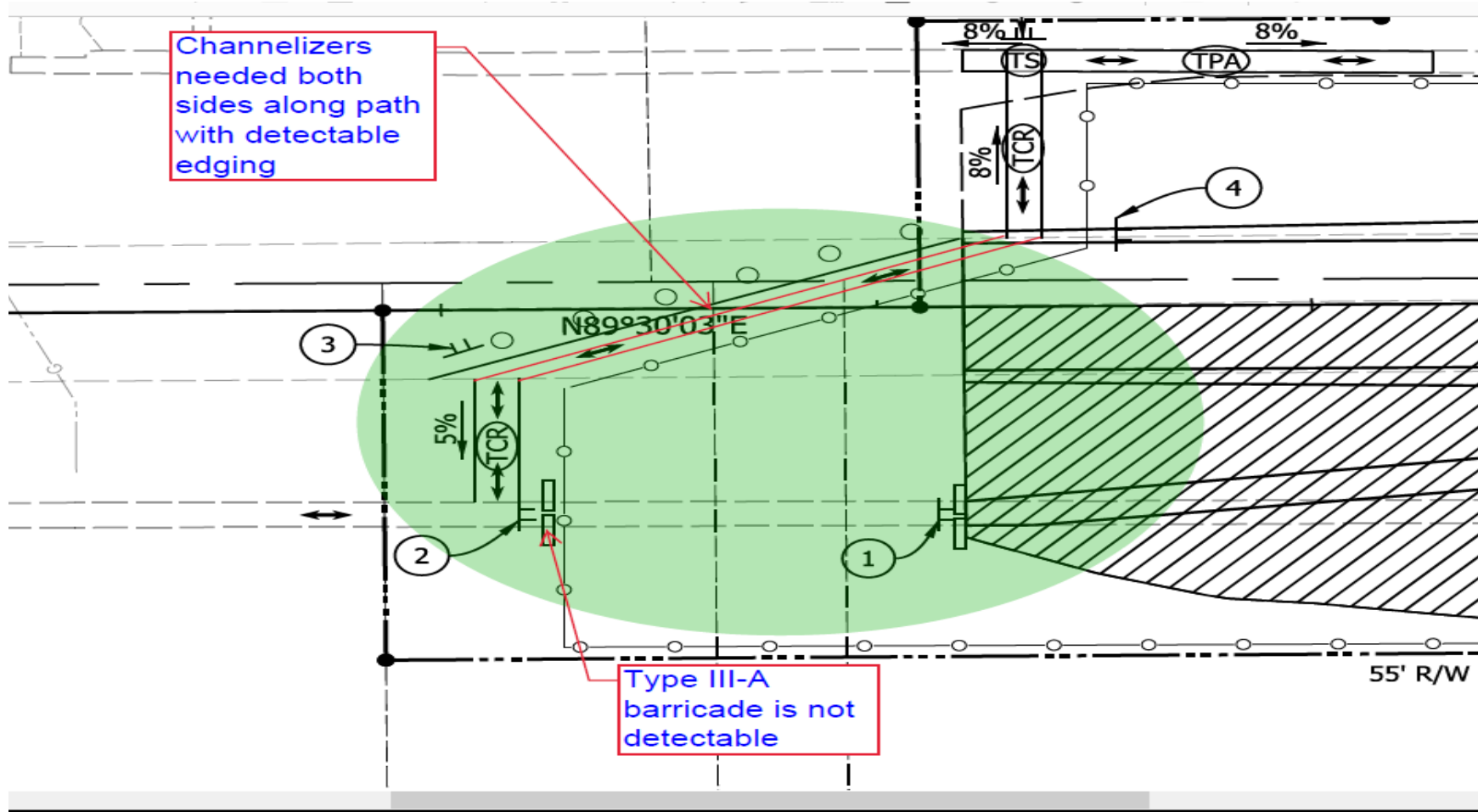

Comments on stage 2

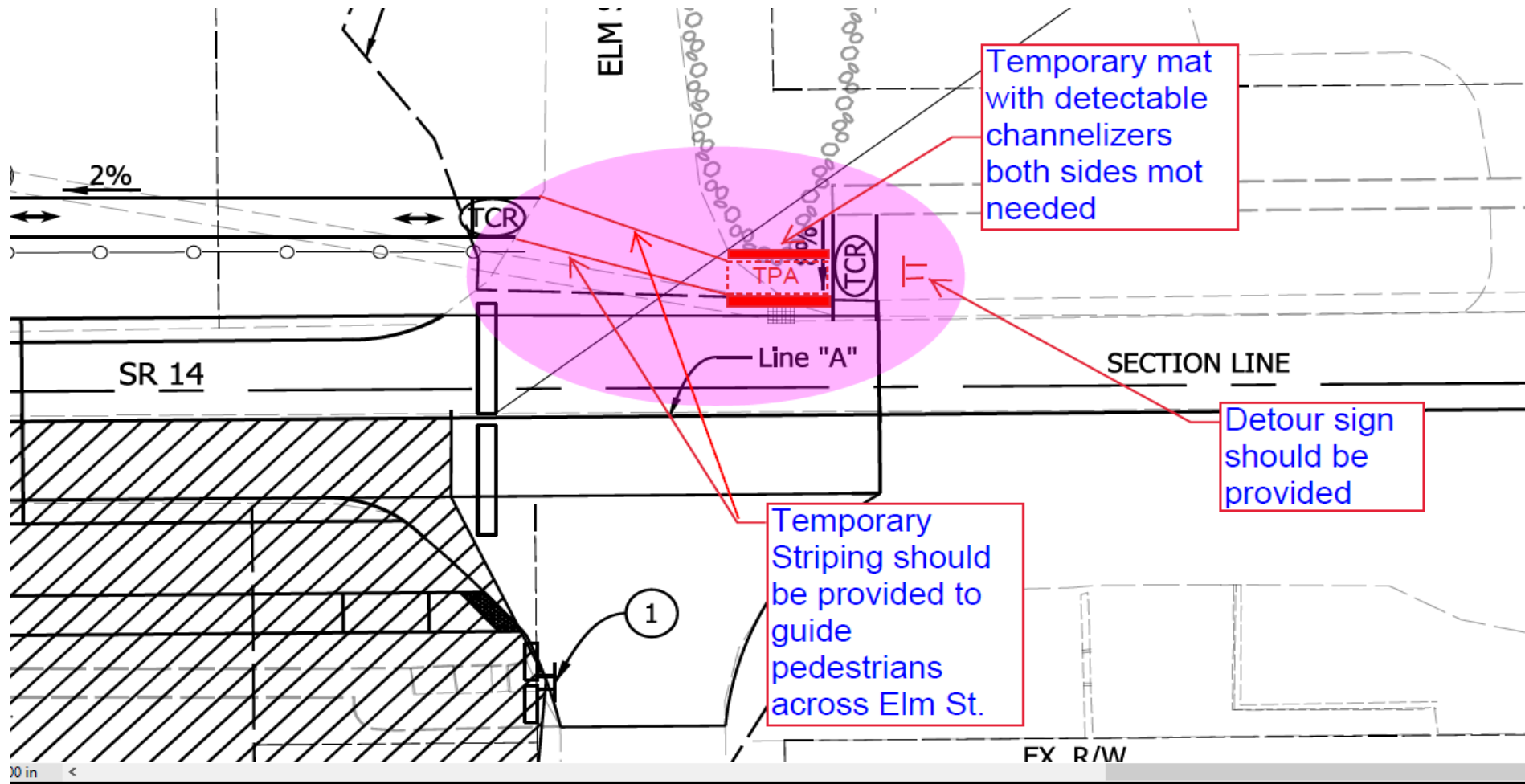

Comments on stage 2

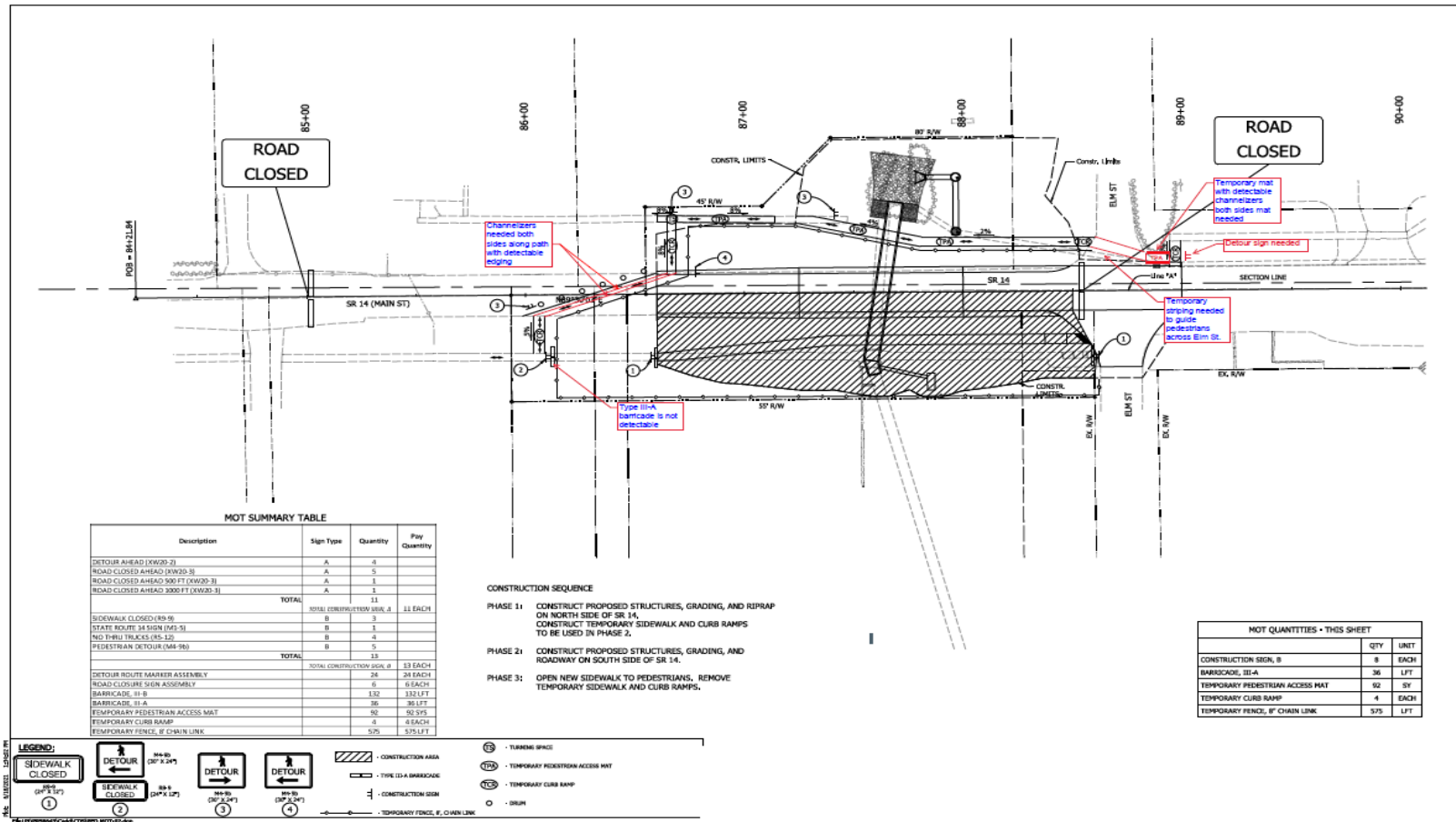

Actual MOT provided during construction

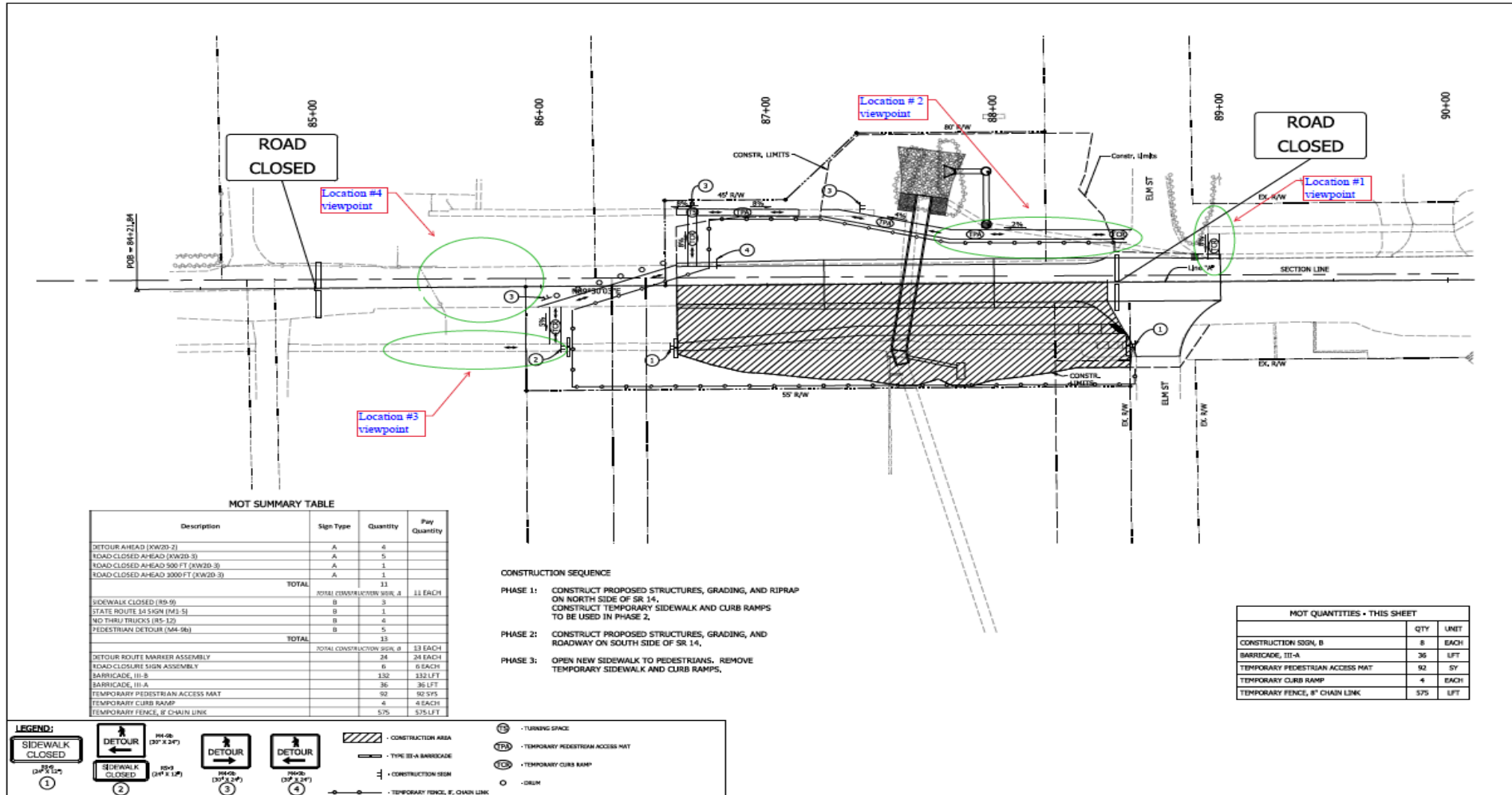

Plan Sheet Location 1

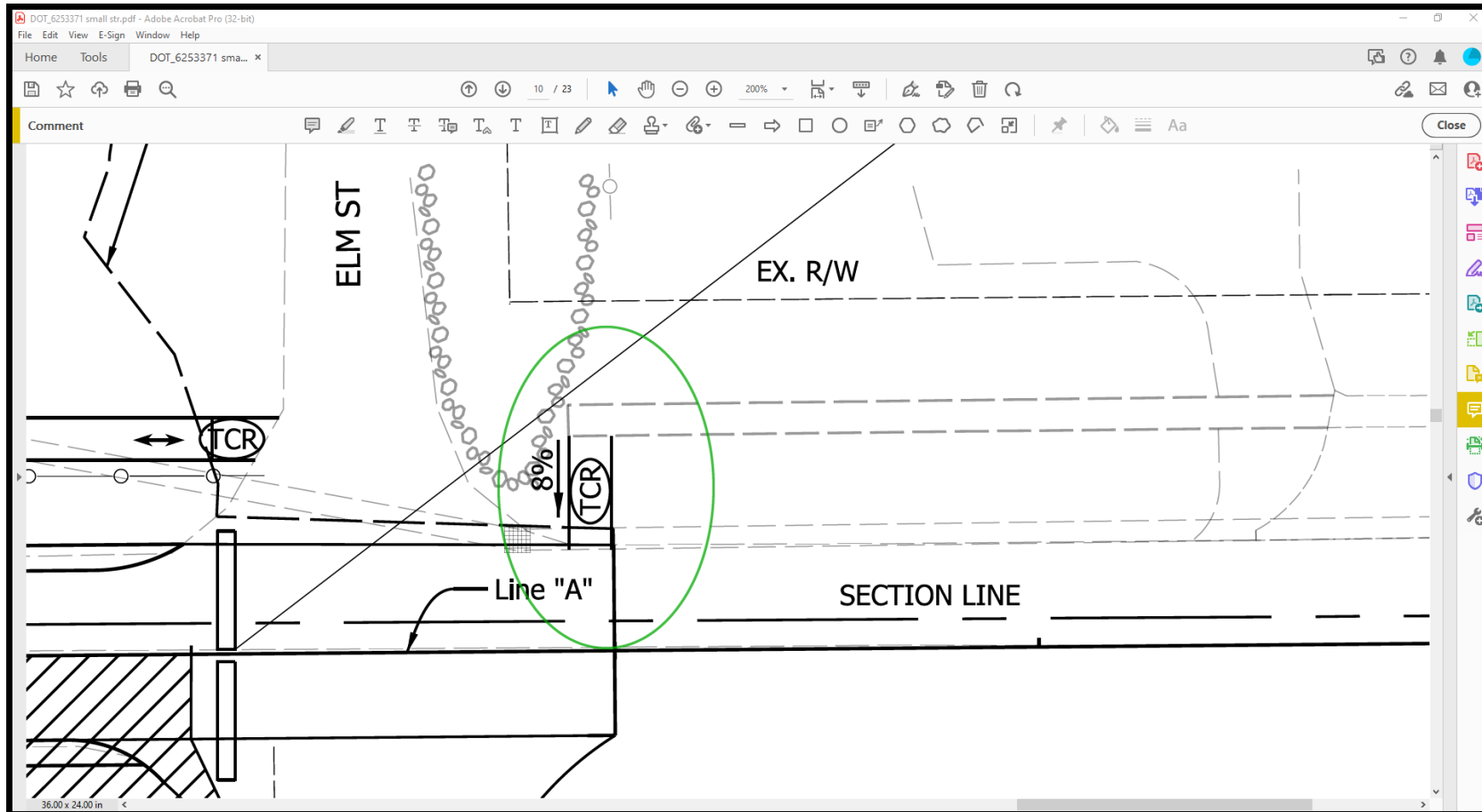

Location 1 – Actually provided



Location 1 – Additional items needed

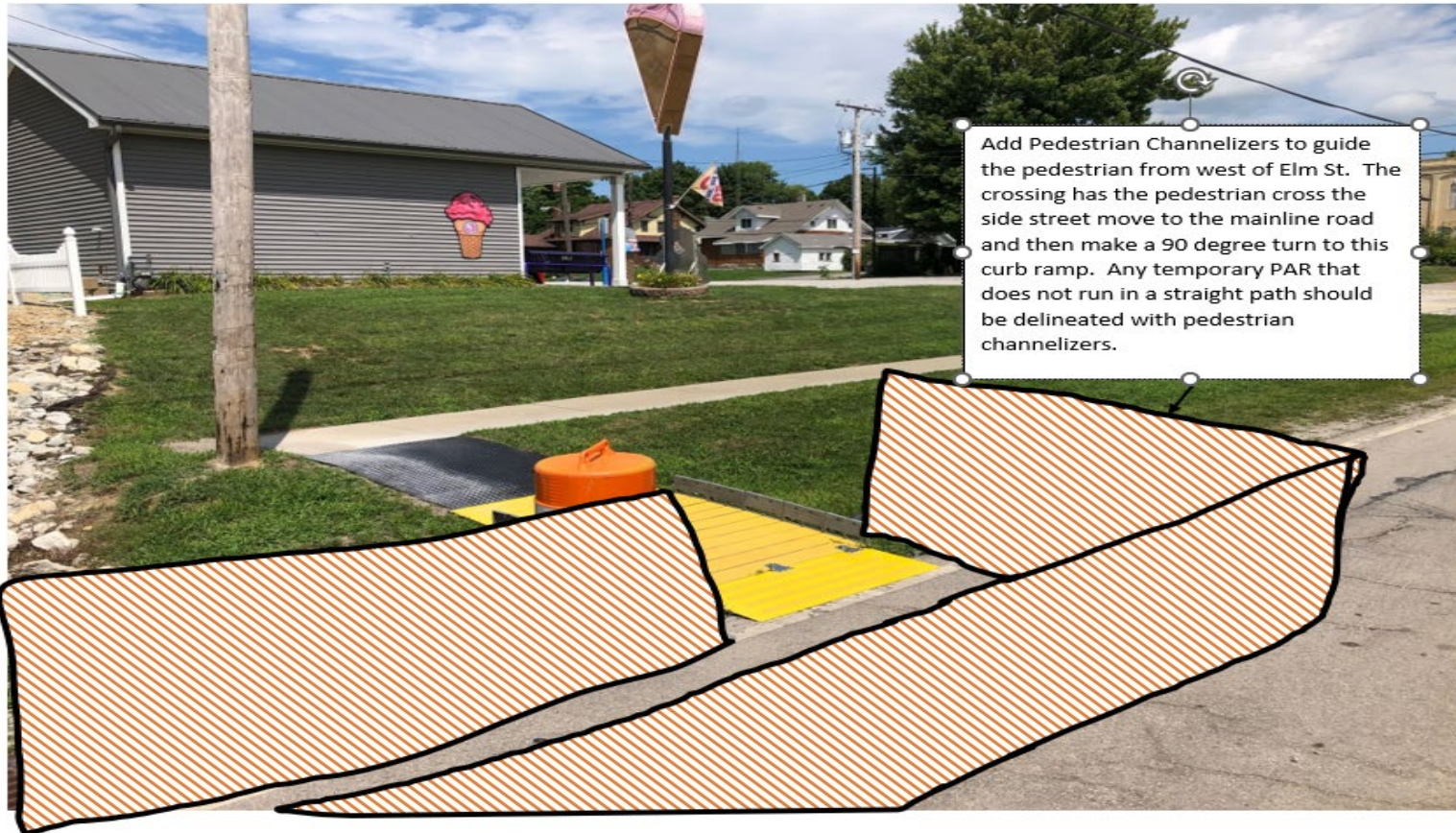

Plan Sheet Location 2

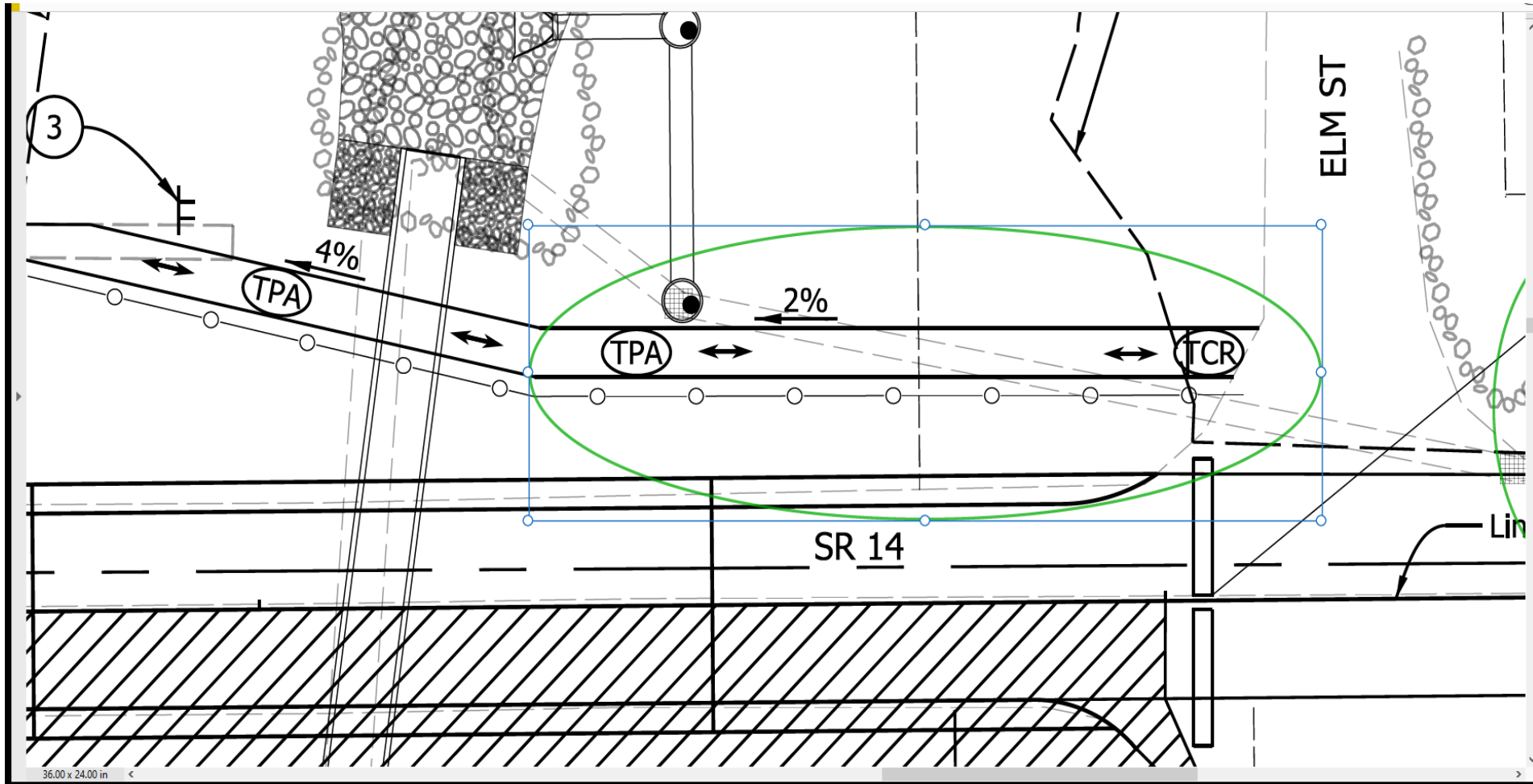

36.00 x 24.00 in

Location 2 – Actually provided



Location 2 – Additional items needed



Plan Sheet Location 3

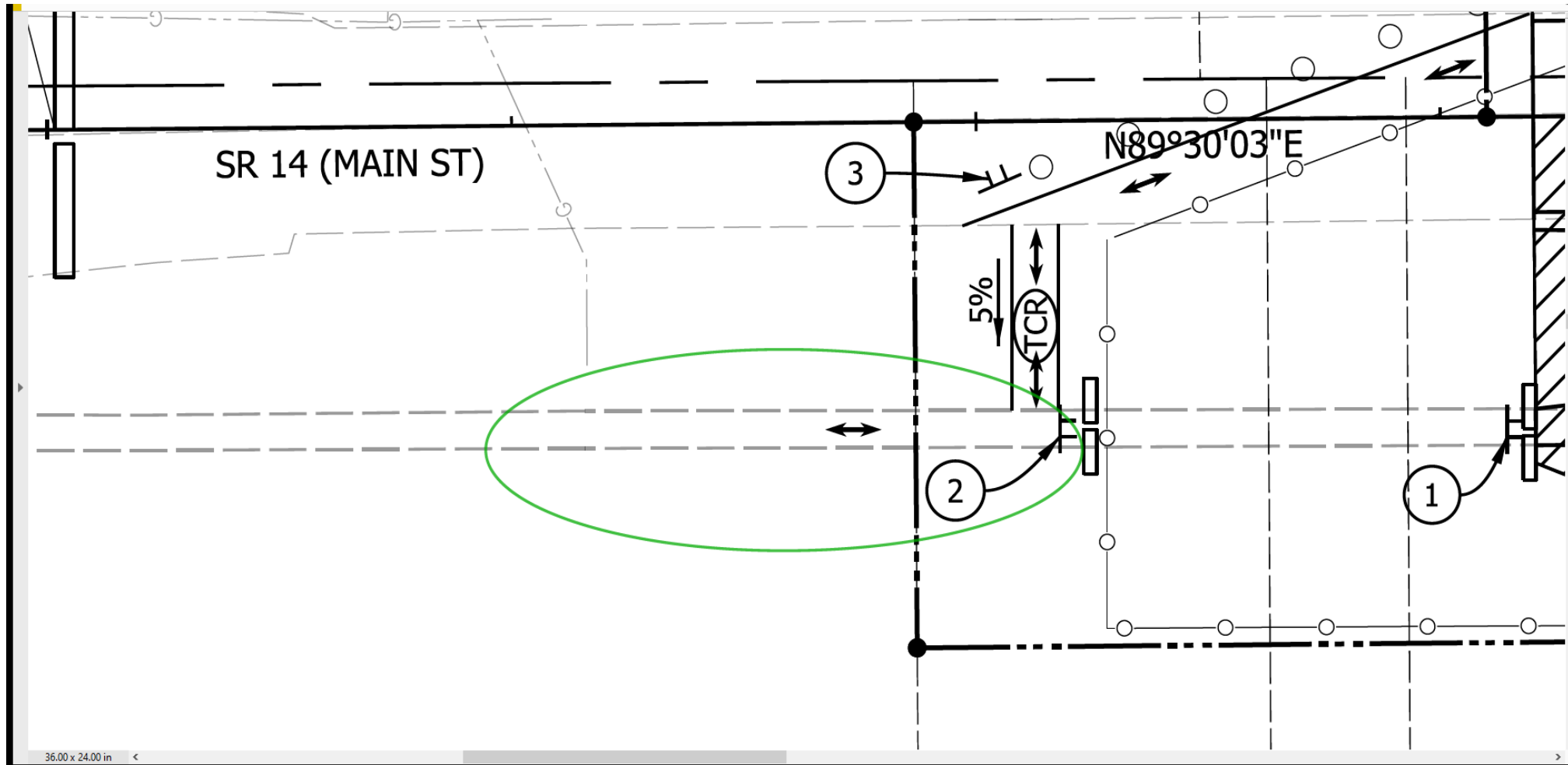

Location 3 – Actually provided



Location 3 – Additional items needed

rst we need to close some apps.

Update now



Plan sheet location 4

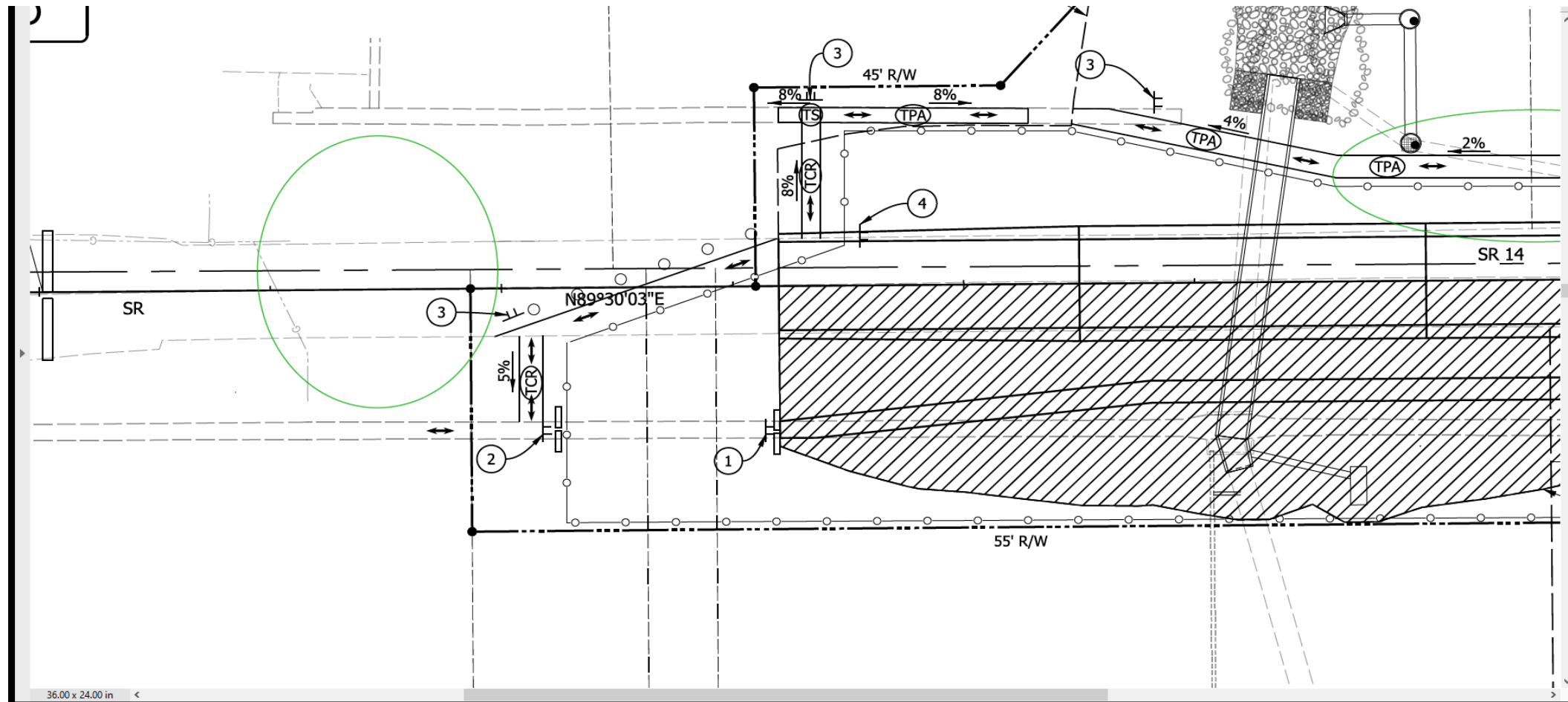

Location 4 – Actually provided



Location 4 – Additional items needed



Long Detour Example

Location curb ramp SE corner Side street & SR 19

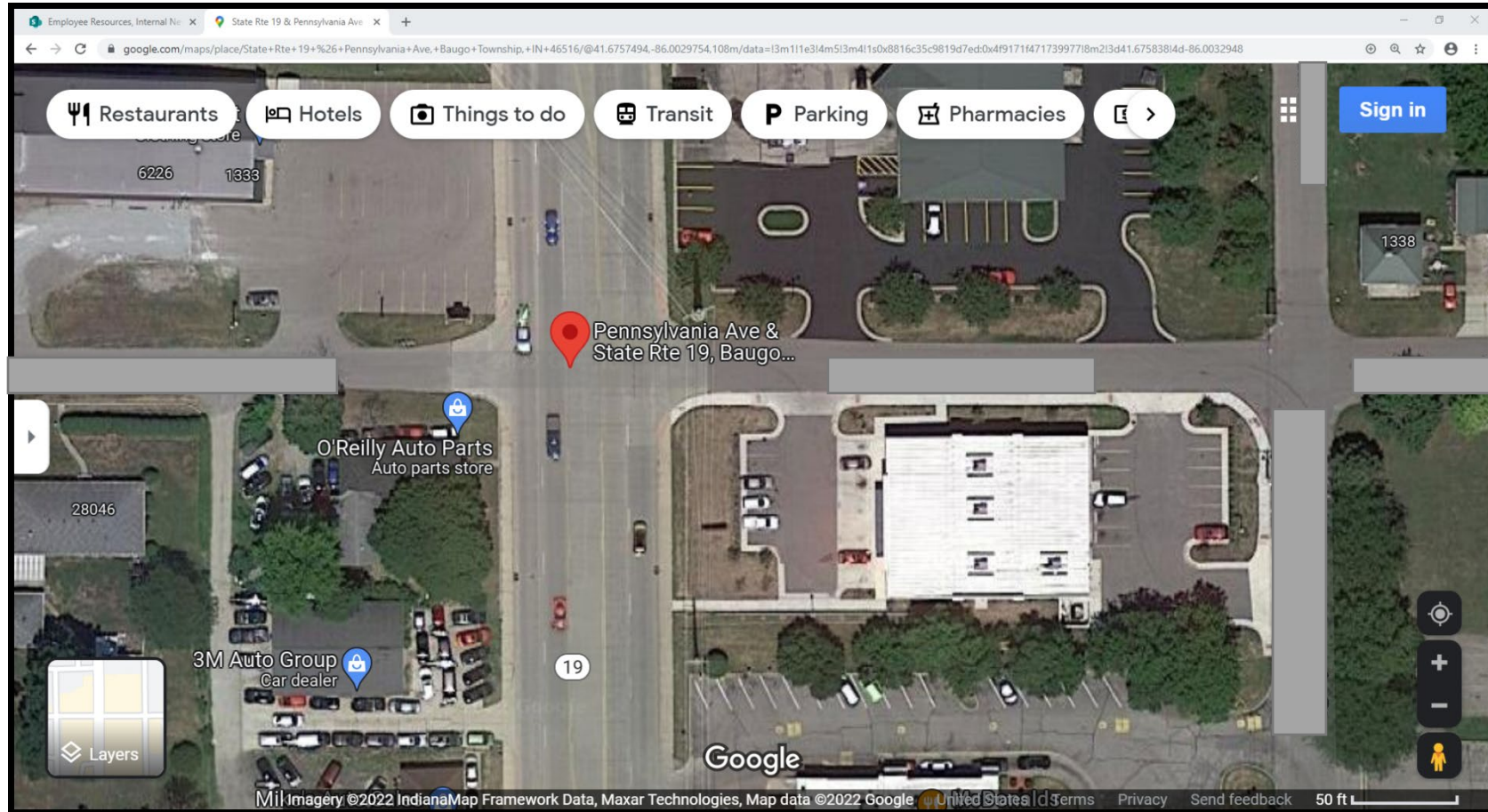

Proposed design

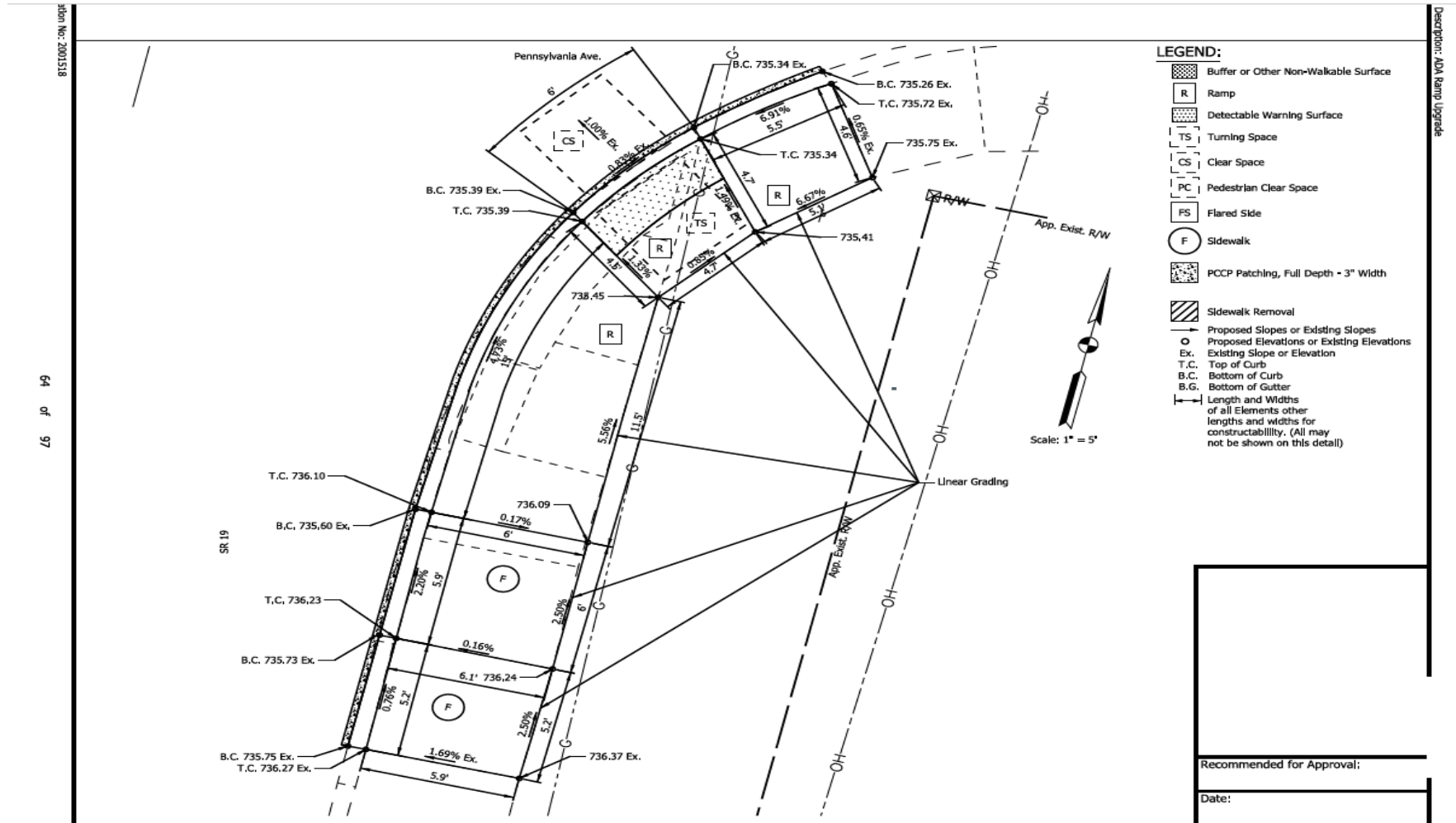

Job No. 2001518

64 of 97

Description: ADA Ramp Upgrade

Pedestrian paths affected



Will a diversion along right-of-way side work ?

Due to lack of available existing Right-of-way to bypass the proposed construction this can't be done. Try next option which is Street side diversion.



Will a diversion along street side work ?

Sidewalks along SR 19 and Pennsylvania are adjacent to the curb. A diversion on the street sides would restrict the outside lane on SR 19 which District traffic does not desire and due to width of Pennsylvania make existing two way traffic not possible. Try next option which is mid-block crossing



Will a mid-block crossing work?

Providing a midblock crossing across Pennsylvania Street would require Pennsylvania Street to be closed and there is no existing sidewalk on north side of Pennsylvania. Providing a midblock crossing for SR 19 is infeasible and unsafe due to number of lanes of traffic needed to be crossed and the roadway width, along with the high traffic volumes and speeds. Try next option which is a short detour.



Will a short detour work?

A short detour which is defined as being no greater than one block which is an area of land surrounded by four streets, is not possible because there is no sidewalk along the north side of Pennsylvania nor a crossing at the intersection of Laramie and Pennsylvania to accommodate the east west movement on the south side of Pennsylvania. There is also not an existing crossing of SR 19 and Indiana Ave to accommodate the north south movement on the east side of SR 19. Try next option which is a long detour.

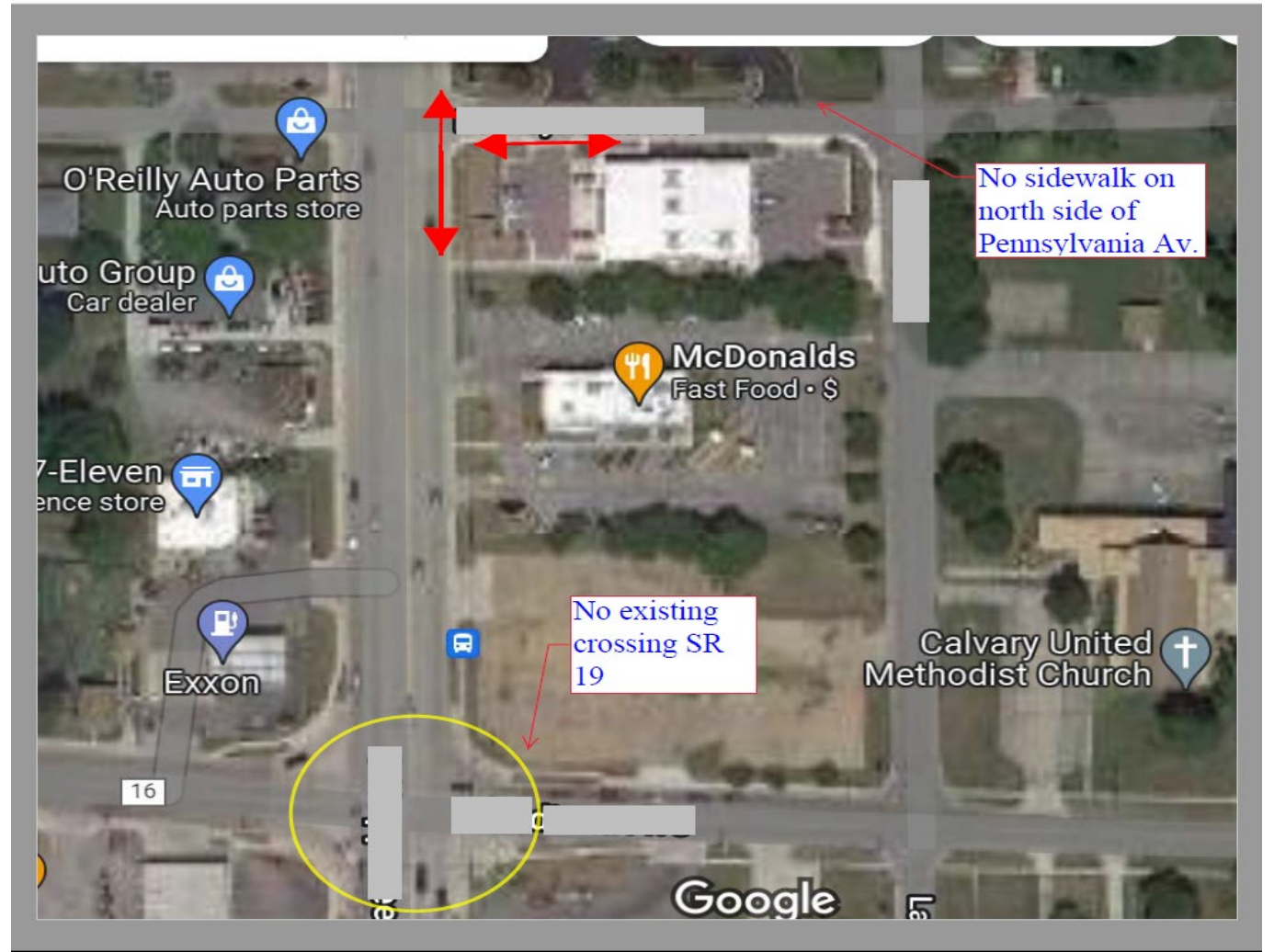

Will a long detour work?

North South movement SR 19

A long detour will work for providing an alternate path for the north south pedestrian movement by using the existing crossings at Lexington Av. and Franklin St. In order to keep the public informed about the impending curb ramp construction in the SE corner, signage will need to be added which gives a date when the sidewalk will be closed and the detour will need to be used a week before the actual closure. Also a USP will need to be developed which limits the construction time for this ramp to 3 days so pedestrians will be inconvenienced by the long detour for a short period of time

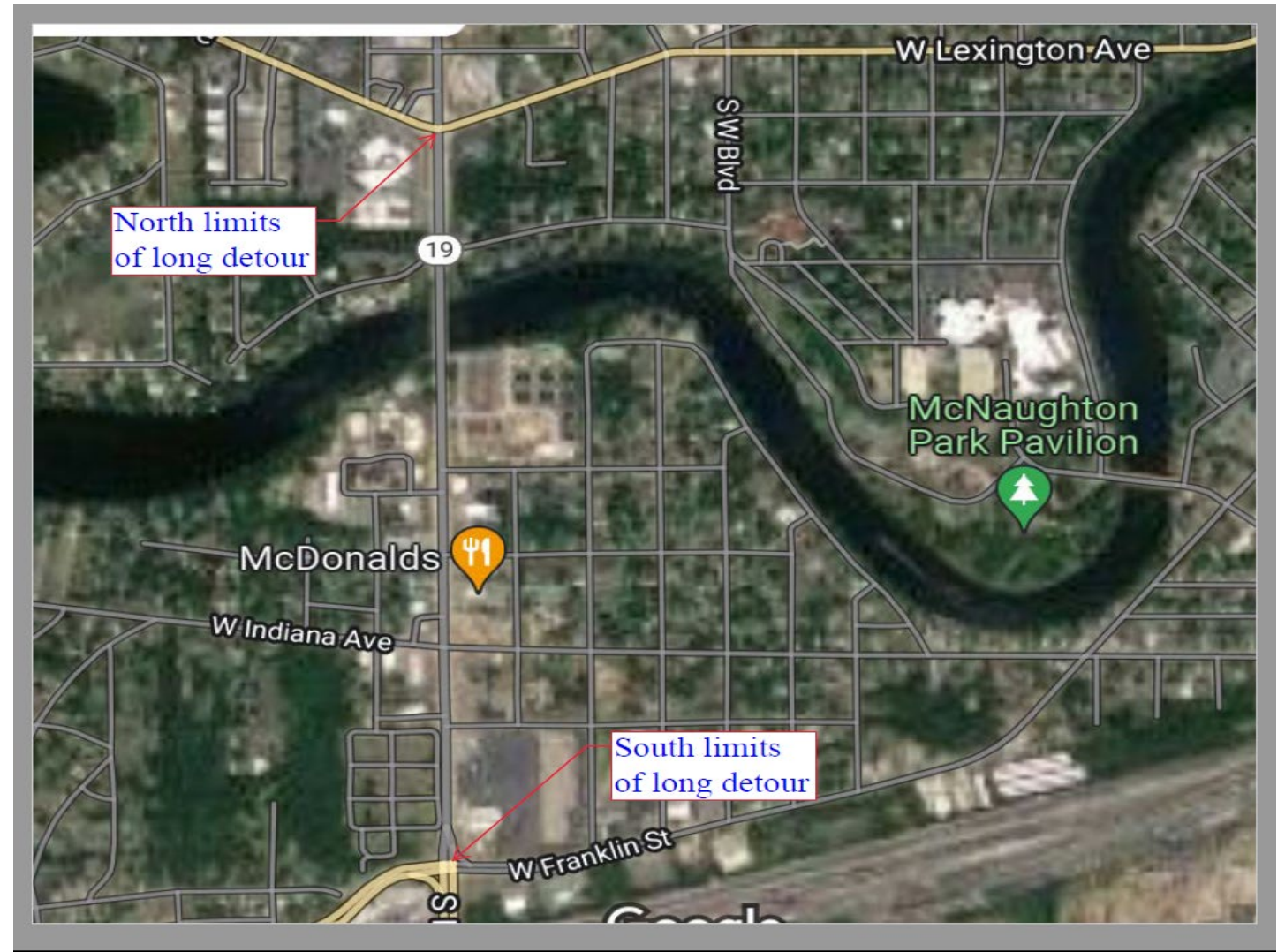

Will a long detour work?

East west movement along Pennsylvania

Because the existing sidewalk on Pennsylvania only extends to Laramie and then for about 122' along Laramie and it does not connect to any other existing sidewalks a long detour is not possible.

Therefore when the SE corner ramp is constructed an alternate route for pedestrians will not be provided for the existing east west route on Pennsylvania. Seven days before construction begins signage will need to be provided which gives a date when the sidewalk will be closed. Also a USP will need to be developed which limits construction to 3 days



Diagram Long detour

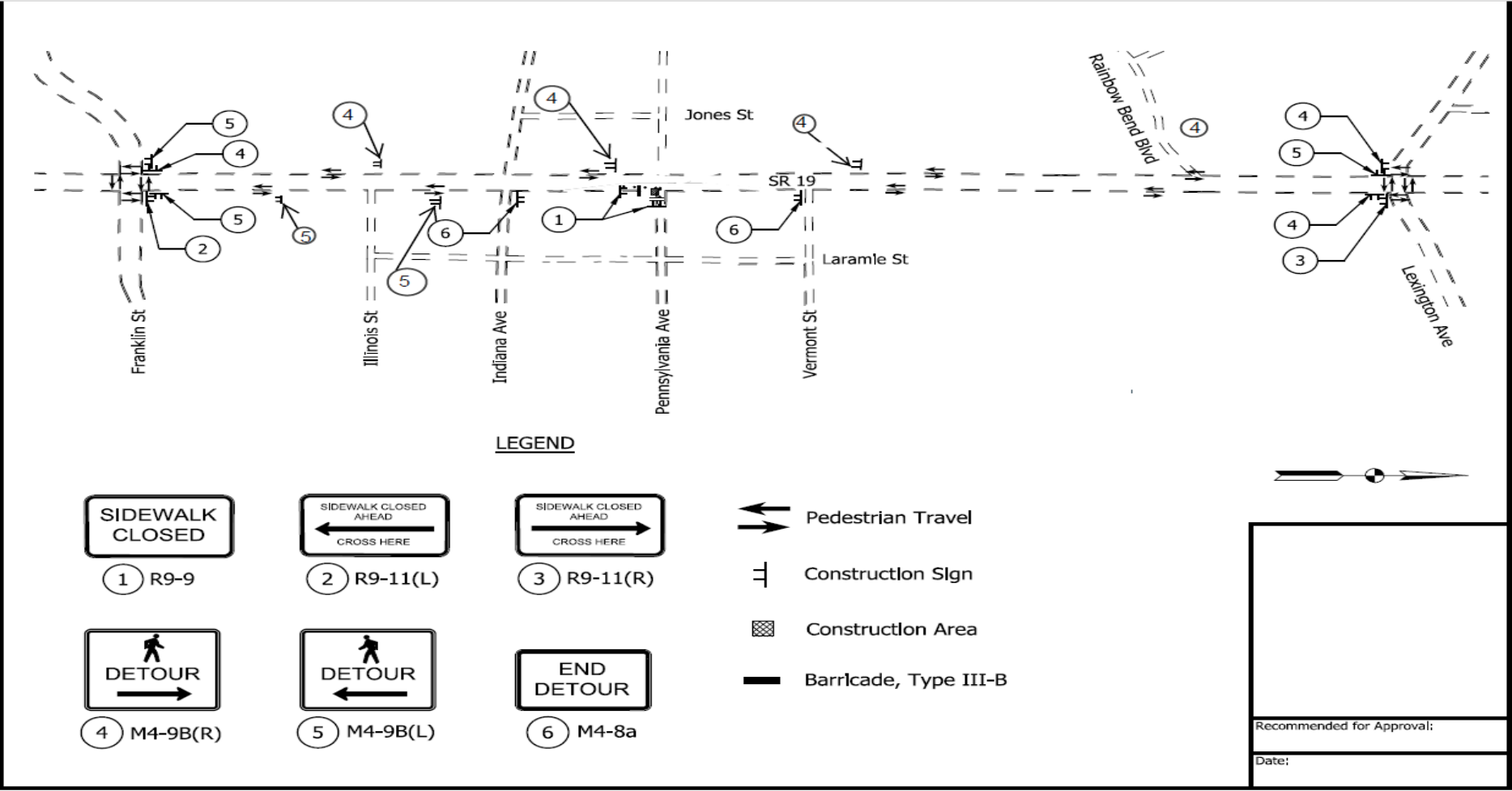

Question???

Herbert Davis, Review ADA Engineer

hdavis@indot.in.gov

Katherine Smutzer, Work Zone Safety Engineer

ksmutzer@indot.in.gov